

## *Topics in Absolute Anabelian Geometry III: Global Reconstruction Algorithms*

By Shinichi MOCHIZUKI

**Abstract.** In the present paper, which forms the third part of a three-part series on an *algorithmic* approach to *absolute anabelian geometry*, we apply the absolute anabelian technique of *Belyi cuspidalization* developed in the second part, together with certain ideas contained in an earlier paper of the author concerning the category-theoretic representation of holomorphic structures via either the topological group  $SL_2(\mathbb{R})$  or the use of “parallelograms, rectangles, and squares”, to develop a certain *global formalism* for certain hyperbolic orbicurves related to a once-punctured elliptic curve over a number field. This formalism allows one to construct certain *canonical rigid integral structures*, which we refer to as *log-shells*, that are obtained by applying the *logarithm* at various primes of a number field. Moreover, although each of these local logarithms is “far from being an isomorphism” both in the sense that it *fails to respect the ring structures involved* and in the sense (cf. Frobenius morphisms in positive characteristic!) that it has the effect of exhibiting the “mass” represented by its domain as a “*somewhat smaller collection of mass*” than the “mass” represented by its codomain, this global formalism allows one to treat the logarithm operation as a *global operation* on a number field which satisfies the property of being an “*isomorphism up to an appropriate renormalization operation*”, in a fashion that is reminiscent of the isomorphism induced on differentials by a Frobenius lifting, *once one divides by  $p$* . More generally, if one thinks of *number fields* as corresponding to *positive characteristic hyperbolic curves* and of *once-punctured elliptic curves* on a number field as corresponding to *nilpotent ordinary indigenous bundles* on a positive characteristic hyperbolic curve, then many aspects of the theory developed in the present paper are reminiscent of (the positive characteristic portion of)  *$p$ -adic Teichmüller theory*.

---

2010 *Mathematics Subject Classification.* Primary 14H30; Secondary 14H25.

Key words: Absolute anabelian geometry, mono-anabelian, core, Belyi cuspidalization, elliptic cuspidalization, arithmetic holomorphic structure, mono-analytic, log-Frobenius, log-shell, log-volume.

**Contents:**

Introduction

§0. Notations and Conventions

§1. Galois-theoretic Reconstruction Algorithms

§2. Archimedean Reconstruction Algorithms

§3. Nonarchimedean Log-Frobenius Compatibility

§4. Archimedean Log-Frobenius Compatibility

§5. Global Log-Frobenius Compatibility

Appendix: Complements on Complex Multiplication

**Introduction**

§I1. Summary of Main Results

§I2. Fundamental Naive Questions Concerning Anabelian Geometry

§I3. Dismantling the Two Combinatorial Dimensions of a Ring

§I4. Mono-anabelian Log-Frobenius Compatibility

§I5. Analogy with  $p$ -adic Teichmüller Theory

Acknowledgements

**§I1. Summary of Main Results**

Let  $k$  be a finite extension of the field  $\mathbb{Q}_p$  of  $p$ -adic numbers (for  $p$  a prime number);  $\bar{k}$  an algebraic closure of  $k$ ;  $G_k \stackrel{\text{def}}{=} \text{Gal}(\bar{k}/k)$ . Then the starting point of the theory of the present paper lies in the *elementary observation* that although the  $p$ -adic logarithm

$$\log_{\bar{k}} : \bar{k}^{\times} \rightarrow \bar{k}$$

(normalized so that  $p \mapsto 0$ ) is *not a ring homomorphism*, it does satisfy the important property of being *Galois-equivariant* (i.e.,  $G_k$ -equivariant).

In a similar vein, if  $\bar{F}$  is an algebraic closure of a *number field*  $F$ ,  $G_F \stackrel{\text{def}}{=} \text{Gal}(\bar{F}/F)$ , and  $k, \bar{k}$  arise, respectively, as the completions of  $F, \bar{F}$  at a nonarchimedean prime of  $\bar{F}$ , then although the map  $\log_{\bar{k}}$  *does not extend*, in any natural way, to a map  $\bar{F}^{\times} \rightarrow \bar{F}$  (cf. Remark 5.4.1), it does extend to the “*disjoint union of the  $\log_{\bar{k}}$ ’s at all the nonarchimedean primes of  $\bar{F}$ ” in a fashion that is *Galois-equivariant* (i.e.,  $G_F$ -equivariant) with respect to the natural action of  $G_F$  on the resulting disjoint unions of the various  $\bar{k}^{\times} \subseteq \bar{k}$ .*

Contemplation of the elementary observations made above led the author to the following point of view:

The *fundamental geometric framework* in which the logarithm operation should be understood is *not* the ring-theoretic framework of scheme theory, but rather a geometric framework based solely on the *abstract profinite groups*  $G_k$ ,  $G_F$  (i.e., the Galois groups involved), i.e., a framework which satisfies the key property of being “*immune*” to the operation of applying the *logarithm*.

Such a group-theoretic geometric framework is precisely what is furnished by the *enhancement of absolute anabelian geometry* — which we shall refer to as *mono-anabelian geometry* — that is developed in the present paper.

This enhancement may be thought of as a natural outgrowth of the *algorithm-based approach* to absolute anabelian geometry, which forms the unifying theme (cf. the Introductions to [Mzk20], [Mzk21]) of the three-part series of which the present paper constitutes the third, and final, part. From the point of view of the present paper, certain portions of the theory and results developed in earlier papers of the present series — most notably, the theory of *Belyi cuspidalizations* developed in [Mzk21], §3 — are relevant to the theory of the present paper partly because of their *logical necessity* in the proofs, and partly because of their *philosophical relevance* (cf., especially, the discussion of “*hidden endomorphisms*” in the Introduction to [Mzk21]; the theory of [Mzk21], §2).

Note that a *ring* may be thought of as a mathematical object that consists of “*two combinatorial dimensions*”, corresponding to its *additive structure*, which we shall denote by the symbol  $\boxplus$ , and its *multiplicative structure*, which we shall denote by the symbol  $\boxtimes$  (cf. Remark 5.6.1, (i), for more details). One way to understand the *failure* of the logarithm to be compatible with the *ring structures* involved is as a manifestation of the fact that the logarithm has the effect of “*tinkering with, or dismantling, this two-dimensional structure*”. Such a dismantling operation cannot be understood within the framework of ring (or scheme) theory. That is to say, it may only be understood from the point of view of a geometric framework that “*lies essentially outside*”, or “*is neutral with respect to*”, this two-dimensional structure (cf. the illustration of Remark 5.10.2, (iii)).

One important property of the  $p$ -adic logarithm  $\log_{\bar{k}}$  discussed above is that the image

$$\log_{\bar{k}}(\mathcal{O}_k^\times) \subseteq k$$

— which is *compact* — may be thought of as defining a sort of *canonical rigid integral structure* on  $k$ . In the present paper, we shall refer to the “canonical rigid integral structures” obtained in this way as *log-shells*. Note that the image  $\log_{\bar{k}}(k^\times)$  of  $k^\times$  via  $\log_{\bar{k}}$  is, like  $\log_{\bar{k}}(\mathcal{O}_k^\times)$  (but unlike  $k^\times!$ ), *compact*. That is to say, the operation of applying the  $p$ -adic logarithm may be thought of as a sort of “*compression*” operation that *exhibits the “mass” represented by its domain as a “somewhat smaller collection of mass” than the “mass” represented by its codomain*. In this sense, the  $p$ -adic logarithm is reminiscent of the *Frobenius morphism* in positive characteristic (cf. Remark 3.6.2 for more details). In particular, this “compressing nature” of the  $p$ -adic logarithm may be thought of as being one that lies in *sharp contrast* with the nature of an *étale morphism*. This point of view is reminiscent of the discussion of the “*fundamental dichotomy*” between “*Frobenius-like*” and “*étale-like*” structures in the Introduction of [Mzk16]. In the classical  $p$ -adic theory, the notion of a *Frobenius lifting* (cf. the theory of [Mzk1], [Mzk4]) may be thought of as forming a *bridge* between the two sides of this dichotomy (cf. the discussion of *mono-theta environments* in the Introduction to [Mzk18]!) — that is to say, a Frobenius lifting is, on the one hand, literally a lifting of the Frobenius morphism in positive characteristic and, on the other hand, tends to satisfy the property of being *étale in characteristic zero*, i.e., of inducing an isomorphism on differentials, *once one divides by  $p$* .

In a word, the theory developed in the present paper may be summarized as follows:

The thrust of the theory of the present paper lies in the development of a formalism, via the use of ring/scheme structures reconstructed via *mono-anabelian geometry*, in which the “*dis-mantling/compressing nature*” of the logarithm operation discussed above (cf. the Frobenius morphism in positive characteristic) is “*reorganized*” in an abstract combinatorial fashion that exhibits the *logarithm* as a *global operation* on a number field which, moreover, is a sort of “*isomorphism up to an appro-*

*prate renormalization operation*” (cf. the isomorphism induced on differentials by a Frobenius lifting, *once one divides by  $p$* ).

One important aspect of this theory is the analogy between this theory and (the positive characteristic portion of)  *$p$ -adic Teichmüller theory* (cf. §I5 below), in which the “naive pull-back” of an indigenous bundle by Frobenius never yields a bundle isomorphic to the original indigenous bundle, but the “*renormalized Frobenius pull-back*” does, in certain cases, allow one to obtain an output bundle that is isomorphic to the original input bundle.

At a more detailed level, the *main results* of the present paper may be summarized as follows:

In §1, we develop the *absolute anabelian algorithms* that will be necessary in our theory. In particular, we obtain a *semi-absolute group-theoretic reconstruction algorithm* (cf. Theorem 1.9, Corollary 1.10) for hyperbolic orbicurves of *strictly Belyi type* (cf. [Mzk21], Definition 3.5) over *sub- $p$ -adic fields* — i.e., such as number fields and nonarchimedean completions of number fields — that is *functorial* with respect to base-change of the base field. Moreover, we observe that the only “*non-elementary*” ingredient of these algorithms is the technique of *Belyi cuspidalization* developed in [Mzk21], §3, which depends on the main results of [Mzk5] (cf. Remark 1.11.3). If one eliminates this non-elementary ingredient from these algorithms, then, in the case of *function fields*, one obtains a *very elementary semi-absolute group-theoretic reconstruction algorithm* (cf. Theorem 1.11), which is valid over somewhat more general base fields, namely base fields which are “*Kummer-faithful*” (cf. Definition 1.5). The results of §1 are of interest as *anabelian results* in their own right, independent of the theory of later portions of the present paper. For instance, it is hoped that elementary results such as Theorem 1.11 may be of use in *introductions to anabelian geometry* for *advanced undergraduates* or *non-specialists* (cf. [Mzk8], §1).

In §2, we develop an *archimedean* — i.e., *complex analytic* — analogue of the theory of §1. One important theme in this theory is the definition of “archimedean structures” which, like *profinite Galois groups*, are “*immune to the ring structure-dismantling and compressing nature of the logarithm*”. For instance, the notion that constitutes the archimedean counterpart to the notion of a profinite Galois group is the notion of an *Aut-holomorphic structure* (cf. Definition 2.1; Proposition 2.2; Corollary 2.3), which was motivated by the category-theoretic approach to holomorphic structures via

the use of the topological group  $SL_2(\mathbb{R})$  given in [Mzk14], §1. In this context, one central fact is the rather elementary observation that the group of holomorphic or anti-holomorphic automorphisms of the unit disc in the complex plane is *commensurably terminal* (cf. [Mzk20], §0) in the group of self-homeomorphisms of the unit disc (cf. Proposition 2.2, (ii)). We also give an “*algorithmic refinement*” of the “*parallelograms, rectangles, squares approach*” of [Mzk14], §2 (cf. Propositions 2.5, 2.6). By combining these two approaches and applying the technique of *elliptic cuspidalization* developed in [Mzk21], §3, we obtain a certain reconstruction algorithm (cf. Corollary 2.7) for the “*local linear holomorphic structure*” of an Aut-holomorphic orbispace arising from an *elliptically admissible* (cf. [Mzk21], Definition 3.1) hyperbolic orbicurve, which is *compatible* with the *global portion* of the Galois-theoretic theory of §1 (cf. Corollaries 2.8, 2.9).

In §3, §4, we develop the *category-theoretic formalism* — centering around the notions of *observables*, *telecores*, and *cores* (cf. Definition 3.5) — that are applied to express the *compatibility* of the “*mono-anabelian*” construction algorithms of §1 (cf. Corollary 3.6) and §2 (cf. Corollary 4.5) with the “*log-Frobenius functor log*” (in essence, a version of the usual “logarithm” at the various nonarchimedean and archimedean primes of a number field). We also study the *failure of log-Frobenius compatibility* that occurs if one attempts to take the “*conventional anabelian*” — which we shall refer to as “*bi-anabelian*” — approach to the situation (cf. Corollary 3.7). Finally, in the remarks following Corollaries 3.6, 3.7, we discuss in detail the meaning of the various new category-theoretic notions that are introduced, as well as the various aspects of the analogy between these notions, in the context of Corollaries 3.6, 3.7, and the *classical  $p$ -adic theory of the  $\mathcal{MF}^\nabla$ -objects of [Falt]*.

In §5, we develop a *global formalism* over number fields in which we study the *canonical rigid integral structures* — i.e., *log-shells* — that are obtained by applying the log-Frobenius compatibility discussed in §3, §4. These log-shells satisfy the following important properties:

- (L1) a log-shell is *compact* and hence of *finite “log-volume”* (cf. Corollary 5.10, (i));
- (L2) the *log-volumes* of (L1) are *compatible* with application of the *log-Frobenius functor* (cf. Corollary 5.10, (ii));
- (L3) log-shells are *compatible* with the operation of “*panalocaliza-*

tion”, i.e., the operation of restricting to the disjoint union of the various primes of a number field in such a way that one “forgets” the *global structure* of the number field (cf. Corollary 5.5; Corollary 5.10, (iii));

- (L4) log-shells are *compatible* with the operation of “*mono-analytification*”, i.e., the operation of “*disabling the rigidity*” of one of the “*two combinatorial dimensions*” of a ring, an operation that corresponds to allowing “*Teichmüller dilations*” in complex and  $p$ -adic Teichmüller theory (cf. Corollary 5.10, (iv)).

In particular, we note that property (L3) may be thought of as a *rigidity* property for certain global arithmetic line bundles (more precisely, the *trivial arithmetic line bundle* — cf. Remarks 5.4.2, 5.4.3) that is analogous to the *very strong* — i.e., by comparison to the behavior of arbitrary vector bundles on a curve — *rigidity properties* satisfied by  $\mathcal{MF}^\nabla$ -objects with respect to *Zariski localization*. Such rigidity properties may be thought of as a sort of “*freezing of integral structures*” with respect to Zariski localization (cf. Remark 5.10.2, (i)). Finally, we discuss in some detail (cf. Remark 5.10.3) the *analogy* — centering around the correspondence

$$\begin{array}{ll} \text{number field } F & \longleftrightarrow \text{hyperbolic curve } C \text{ in pos. char.} \\ \text{once-punctured ell. curve } X \text{ over } F & \longleftrightarrow \text{nilp. ord. indig. bundle } P \text{ over } C \end{array}$$

— between the theory of the present paper (involving hyperbolic orbicurves related to once-punctured elliptic curves over a number field) and the  $p$ -adic *Teichmüller theory* of [Mzk1], [Mzk4] (involving nilpotent ordinary indigenous bundles over hyperbolic curves in positive characteristic).

Finally, in an Appendix to the present paper, we expose the portion of the *well-known theory of abelian varieties with complex multiplication* (cf., e.g., [Lang-CM], [Milne-CM], for more details) that underlies the observation “ $(*_\text{CM})$ ” related to the author by *A. Tamagawa* (cf. [Mzk20], Remark 3.8.1). In particular, we *verify* that this observation  $(*_\text{CM})$  does indeed hold. This implies that the observation “ $(*_\text{A-qLT})$ ” discussed in [Mzk20], Remark 3.8.1, also holds, and hence, in particular, that the hypothesis of [Mzk20], Corollary 3.9, to the effect that “either  $(*_\text{A-qLT})$  or  $(*_\text{CM})$  holds” may be *eliminated* (i.e., that [Mzk20], Corollary 3.9, holds *unconditionally*). Although the content of this Appendix is not directly technically related to the remainder of the present paper, the *global arithmetic* nature of the

content of this Appendix, as well as the accompanying discussion of the relationship of this global content with considerations in *p-adic Hodge theory*, is closely related in spirit to the analogies between the content of the remainder of the present paper and the theory of earlier papers in the present series of papers, i.e., more precisely, [Mzk20], §3; [Mzk21], §2.

## §I2. Fundamental Naive Questions Concerning Anabelian Geometry

One interesting aspect of the theory of the present paper is that it is intimately related to various *fundamental questions* concerning anabelian geometry that are *frequently posed by newcomers to the subject*. Typical examples of these fundamental questions are the following:

- (Q1) *Why* is it useful or meaningful to study *anabelian geometry* in the first place?
- (Q2) What exactly is meant by the term “*group-theoretic reconstruction*” in discussions of anabelian geometry?
- (Q3) What is the significance of studying anabelian geometry over *mixed-characteristic local fields* (i.e., *p-adic local fields*) as opposed to *number fields*?
- (Q4) *Why* is *birational* anabelian geometry *insufficient* — i.e., what is the significance of studying the anabelian geometry of hyperbolic curves, as opposed to their function fields?

In fact, the answers to these questions that are furnished by the theory of the present paper are closely related.

As was discussed in §I1, the answer to (Q1), from the point of view of the present paper, is that anabelian geometry — more specifically, “*mono-anabelian geometry*” — provides a framework that is sufficiently well-endowed as to contain “data reminiscent of the data constituted by various scheme-theoretic structures”, but has the virtue of being based *not on ring structures*, but rather on *profinite (Galois) groups*, which are “*neutral*” with respect to the operation of taking the *logarithm*.

The answer to (Q2) is related to the *algorithmic* approach to absolute anabelian geometry taken in the present three-part series (cf. the Introduction to [Mzk20]). That is to say, typically, in discussions concerning



“Grothendieck Conjecture-type fully faithfulness results” (cf., e.g., [Mzk5]) the term “group-theoretic reconstruction” is defined simply to mean “*preserved by an arbitrary isomorphism between the étale fundamental groups of the two schemes under consideration*”. This point of view will be referred to in the present paper as “*bi-anabelian*”. By contrast, the algorithmic approach to absolute anabelian geometry involves the development of “*software*” whose *input data* consists solely of, for instance, a *single abstract profinite group* (that just happens to be isomorphic to the étale fundamental group of a scheme), and whose *output data* consists of various structures reminiscent of scheme theory (cf. the Introduction to [Mzk20]). This point of view will be referred to in the present paper as “*mono-anabelian*”. Here, the mono-anabelian “software” is required to be *functorial*, e.g., with respect to isomorphisms of profinite groups. Thus, it follows formally that

$$\text{“mono-anabelian”} \implies \text{“bi-anabelian”}$$

(cf. Remark 1.9.8). On the other hand, although it is difficult to formulate such issues completely precisely, the theory of the present paper (cf., especially, §3) suggests strongly that the *opposite implication should be regarded as false*. That is to say, whereas the *mono-anabelian* approach yields a framework that is “*neutral*” with respect to the operation of taking the *logarithm*, the *bi-anabelian* approach *fails to yield such a framework* (cf. Corollaries 3.6, 3.7, and the following remarks; §I4 below).

Here, we pause to remark that, in fact, although, historically speaking, many theorems were originally formulated in a “*bi-anabelian*” fashion, careful inspection of their proofs typically leads to the recovery of “*mono-anabelian* algorithms”. Nevertheless, since *formulating theorems in a “mono-anabelian” fashion*, as we have attempted to do in the present paper (and more generally in the present three-part series, but cf. the final portion of the Introduction to [Mzk21]), can be quite *cumbersome* — and indeed is one of the main reasons for the *unfortunately lengthy* nature of the present paper! — it is often convenient to formulate final theorems in a “*bi-anabelian*” fashion. On the other hand, we note that the famous *Neukirch-Uchida theorem* on the anabelian nature of number fields appears to be one important *counterexample* to the above remark. That is to say, to the author’s knowledge, proofs of this result never yield “*explicit mono-anabelian reconstruction algorithms of the given number field*”; by contrast,

Theorem 1.9 of the present paper *does* give such an *explicit construction of the “given number field”* (cf. Remark 1.9.5).

Another interesting aspect of the *algorithmic* approach to anabelian geometry is that one may think of the “software” constituted by such algorithms as a sort of “*combinatorialization*” of the original schemes (cf. Remark 1.9.7). This point of view is reminiscent of the operation of passing from a “scheme-theoretic”  $\mathcal{MF}^\nabla$ -object to an *associated Galois representation*, as well as the general theme in various papers of the author concerning a “category-theoretic approach to scheme theory” (cf., e.g., [Mzk13], [Mzk14], [Mzk16], [Mzk17], [Mzk18]) of “*extracting from scheme-theoretic arithmetic geometry the abstract combinatorial patterns that underlie the scheme theory*”.

The answer to (Q3) provided by the theory of the present paper is that the *absolute  $p$ -adic (mono-)anabelian* results of §1 underlie the *panalocalizability of log-shells* discussed in §I1 (cf. property (L3)). Put another way, these results imply that the “*geometric framework immune to the application of the logarithm*” — i.e., immune to the *dismantling* of the “ $\boxplus$ ” and “ $\boxtimes$ ” dimensions of a ring — discussed in §I1 may be applied *locally* at each prime of a number field *regarded as an isolated entity*, i.e., without making use of the global structure of the number field — cf. the discussion of “freezing of integral structures” with respect to Zariski localization in Remark 5.10.2, (i). For more on the significance of the operation of passing “ $\boxtimes \rightsquigarrow \boxplus$ ” in the context of nonarchimedean log-shells — i.e., the operation of passing “ $\mathcal{O}_k^\times \rightsquigarrow \log_{\bar{k}}(\mathcal{O}_k^\times)$ ” — we refer to the discussion of nonarchimedean log-shells in §I3 below.

The answer to (Q4) furnished by the theory of the present paper (cf. Remark 1.11.4) — i.e., one fundamental difference between *birational* anabelian geometry and the anabelian geometry of *hyperbolic curves* — is that (unlike spectra of function fields!) “most” hyperbolic curves admit “*cores*” (in the sense of [Mzk3], §3; [Mzk10], §2), which may be thought of as a sort of *abstract “covering-theoretic” analogue* (cf. Remark 1.11.4, (ii)) of the notion of a “*canonical rigid integral structure*” (cf. the discussion of *log-shells* in §I1). Moreover, if one attempts to work with the Galois group of a *function field* supplemented by some additional structure such as the set of cusps — *arising from scheme theory!* — that determines a hyperbolic curve structure, then one must sacrifice the crucial *mono-anabelian* nature

of one's reconstruction algorithms (cf. Remarks 1.11.5; 3.7.7, (ii)).

Finally, we observe that there certainly exist many “fundamental naive questions” concerning anabelian geometry for which the theory of the present paper *does not furnish* any answers. Typical examples of such fundamental questions are the following:

- (Q5) What is the significance of studying the anabelian geometry of *proper* hyperbolic curves, as opposed to *affine* hyperbolic curves?
- (Q6) What is the significance of studying *pro*- $\Sigma$  (where  $\Sigma$  is some nonempty set of prime numbers) anabelian geometry, as opposed to *profinite* anabelian geometry (cf., e.g., Remark 3.7.6 for a discussion of why *pro*- $\Sigma$  anabelian geometry is *ill-suited* to the needs of the theory of the present paper)?
- (Q7) What is the significance of studying anabelian geometry in *positive characteristic*, e.g., over finite fields?

It would certainly be of interest if further developments could shed light on these questions.

### §I3. Dismantling the Two Combinatorial Dimensions of a Ring

As was discussed in §I1, a *ring* may be thought of as a mathematical object that consists of “*two combinatorial dimensions*”, corresponding to its *additive structure*  $\boxplus$  and its *multiplicative structure*  $\boxtimes$  (cf. Remark 5.6.1, (i)). When the ring under consideration is a (say, for simplicity, totally imaginary) *number field*  $F$  or a *mixed-characteristic nonarchimedean local field*  $k$ , these two combinatorial dimensions may also be thought of as corresponding to the *two cohomological dimensions* of the absolute Galois groups  $G_F$ ,  $G_k$  of  $F$ ,  $k$  (cf. [NSW], Proposition 8.3.17; [NSW], Theorem 7.1.8, (i)). In a similar vein, when the ring under consideration is a *complex archimedean field*  $k$  ( $\cong \mathbb{C}$ ), then the two combinatorial dimensions of  $k$  may also be thought of as corresponding to the *two topological* — i.e., *real* — *dimensions* of the underlying topological space of the topological group  $k^\times$ . Note that in the case where the local field  $k$  is nonarchimedean (respectively, archimedean), *precisely one* of the two cohomological (respectively, real) dimensions of  $G_k$  (respectively,  $k^\times$ ) — namely, the dimension corresponding to the *maximal unramified quotient*  $G_k \twoheadrightarrow \widehat{\mathbb{Z}} \cdot \text{Fr}$  (generated

by the Frobenius element) (respectively, the topological subgroup of units  $\mathbb{S}^1 \cong \mathcal{O}_k^\times \subseteq k^\times$ ) is *rigid* with respect to, say, *automorphisms of the topological group*  $G_k$  (respectively,  $k^\times$ ), while the other dimension — namely, the dimension corresponding to the *inertia subgroup*  $I_k \subseteq G_k$  (respectively, the *value group*  $k^\times \rightarrow \mathbb{R}_{>0}$ ) — is *not rigid* (cf. Remark 1.9.4). (In the nonarchimedean case, this phenomenon is discussed in more detail in [NSW], the Closing Remark preceding Theorem 12.2.7.) Thus, each of the various nonarchimedean “ $G_k$ ’s” and archimedean “ $k^\times$ ’s” that arise at the various primes of a number field may be thought of as being a sort of “*arithmetic  $\mathbb{G}_m$* ” — i.e., an abstract arithmetic “*cylinder*” — that decomposes into a (twisted) product of “*units*” (i.e.,  $I_k \subseteq G_k$ ,  $\mathcal{O}_k^\times \subseteq k^\times$ ) and *value group* (i.e.,  $G_k \rightarrow \widehat{\mathbb{Z}} \cdot \text{Fr}$ ,  $k^\times \rightarrow \mathbb{R}_{>0}$ )

$$\begin{array}{ccc} \text{‘arithmetic } \mathbb{G}_m \text{’} & & \text{‘units’} \quad \text{‘}\times\text{’} \quad \text{‘value group’} \\ \left( \begin{array}{c} \nearrow \circ \nearrow \\ \nearrow \circ \nearrow \\ \nearrow \circ \nearrow \end{array} \right) & \simeq & \circ \quad \text{‘}\times\text{’} \quad \left( \begin{array}{c} \nearrow \\ \nearrow \\ \nearrow \end{array} \right) \end{array}$$

with the property that one of these two factors is rigid, while the other is not. Here, it is interesting to note that the correspondence between units/value group and rigid/non-rigid *differs* (i.e., “goes in the opposite direction”) in the nonarchimedean and archimedean cases. This phenomenon is reminiscent of the *product formula* in elementary number theory, as well as of the behavior of the log-Frobenius functor **log** at nonarchimedean versus archimedean primes (cf. Remark 4.5.2; the discussion of *log-shells* in the final portion of the present §I3).

$$\begin{array}{l} \mathbb{C}^\times \quad \simeq \quad \left( \begin{array}{c} \text{rigid} \\ \mathbb{S}^1 \end{array} \right) \times \left( \begin{array}{c} \text{non-rigid} \\ \mathbb{R}_{>0} \end{array} \right) \\ G_k \quad \simeq \quad \left( \begin{array}{c} \text{non-rigid} \\ I_k \end{array} \right) \rtimes \left( \begin{array}{c} \text{rigid} \\ \widehat{\mathbb{Z}} \cdot \text{Fr} \end{array} \right) \end{array}$$

On the other hand, the perfection of the topological group obtained as the image of the *non-rigid* portion  $I_k$  in the abelianization  $G_k^{\text{ab}}$  of  $G_k$  is naturally isomorphic, by local class field theory, to  $k$ . Moreover, by the theory of [Mzk2], the decomposition of this copy of  $k$  (i.e., into sets of elements

with some given  $p$ -adic valuation) determined by the  $p$ -adic valuation on  $k$  may be thought of as corresponding to the *ramification filtration* on  $G_k$  and is *precisely* the data that is “*deformed*” by automorphisms of  $k$  that do *not* arise from field automorphisms. That is to say, this aspect of the non-rigidity of  $G_k$  is quite reminiscent of the non-rigidity of the topological group  $\mathbb{R}_{>0}$  (i.e., of the non-rigidity of the structure on this topological group arising from the usual archimedean valuation on  $\mathbb{R}$ , which determines an isomorphism between this topological group and some “fixed, standard copy” of  $\mathbb{R}_{>0}$ ).

In this context, one of the first important points of the “*mono-anabelian theory*” of §1, §2 of the present paper is that if one supplements a(n) nonarchimedean  $G_k$  (respectively, archimedean  $k^\times$ ) with the data arising from a *hyperbolic orbicurve* (which satisfies certain properties — cf. Corollaries 1.10, 2.7), then this supplementary data has the effect of *rigidifying both dimensions* of  $G_k$  (respectively,  $k^\times$ ). In the case of (a nonarchimedean)  $G_k$ , this data consists of the *outer action of  $G_k$  on the profinite geometric fundamental group* of the hyperbolic orbicurve; in the case of (an archimedean)  $k^\times$ , this data consists, in essence, of the various *local actions of open neighborhoods of the origin of  $k^\times$  on the squares or rectangles* (that lie in the underlying topological (orbi)space of the Riemann (orbi)surface determined by the hyperbolic (orbi)curve) that encode the holomorphic structure of the Riemann (orbi)surface (cf. the theory of [Mzk14], §2). Here, it is interesting to note that these “*rigidifying actions*” are reminiscent of the discussion of “*hidden endomorphisms*” in the Introduction to [Mzk21], as well as of the discussion of “*intrinsic Hodge theory*” in the context of  $p$ -adic Teichmüller theory in [Mzk4], §0.10.

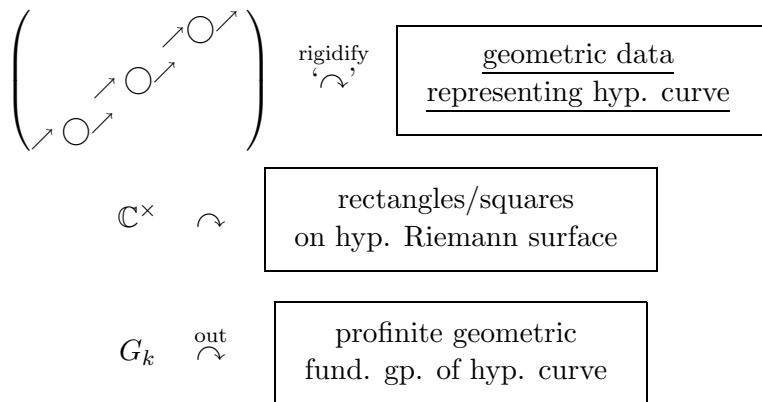

Thus, in summary, the “rigidifying actions” discussed above may be thought of as constituting a sort of “*arithmetic holomorphic structure*” on a nonarchimedean  $G_k$  or an archimedean  $k^\times$ . This arithmetic holomorphic structure is *immune* to the log-Frobenius operation  $\log$  (cf. the discussion of §I1), i.e., immune to the “*juggling of  $\boxplus, \boxtimes$* ” effected by  $\log$  (cf. the illustration of Remark 5.10.2, (iii)).

On the other hand, if one *exits* such a “*zone of arithmetic holomorphy*” — an operation that we shall refer to as *mono-analyticization* — then a nonarchimedean  $G_k$  or an archimedean  $k^\times$  is *stripped* of the rigidity imparted by the above rigidifying actions, hence may be thought of as being subject to *Teichmüller dilations* (cf. Remark 5.10.2, (ii), (iii)). Indeed, this is *intuitively evident* in the archimedean case, in which the quotient  $k^\times \twoheadrightarrow \mathbb{R}_{>0}$  is subject (i.e., upon mono-analyticization, so  $k^\times$  is only considered as a topological group) to automorphisms of the form  $\mathbb{R}_{>0} \ni x \mapsto x^\lambda \in \mathbb{R}_{>0}$ , for  $\lambda \in \mathbb{R}_{>0}$ . If, moreover, one thinks of the value groups of archimedean and nonarchimedean primes as being “*synchronized*” (so as to keep from violating the *product formula* — which plays a crucial role in the theory of “heights”, i.e., degrees of global arithmetic line bundles), then the operation of mono-analyticization necessarily results in analogous “Teichmüller dilations” at nonarchimedean primes. In the context of the theory of *Frobenioids*, such Teichmüller dilations (whether archimedean or nonarchimedean) correspond to the *unit-linear Frobenius functor* studied in [Mzk16], Proposition 2.5. Note that the “*non-linear juggling of  $\boxplus, \boxtimes$  by  $\log$  within a zone of arithmetic holomorphy*” and the “*linear Teichmüller dilations inherent in the operation of mono-analyticization*” are reminiscent of the *Riemannian geometry of the upper half-plane*, i.e., if one thinks of “juggling” as corresponding to *rotations* at a point, and “dilations” as corresponding to *geodesic flows* originating from the point.

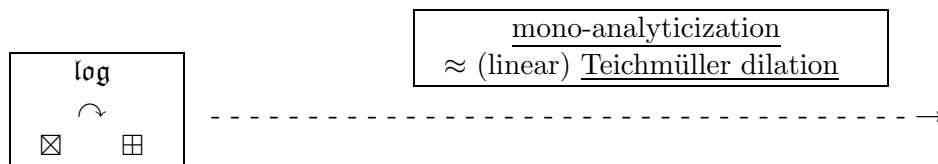

Put another way, the operation of mono-analyticization may be thought of as an operation on the “arithmetic holomorphic structures” discussed above that forms a sort of *arithmetic analogue* of the operation of passing to the

underlying real analytic manifold of a Riemann surface.

<u>number fields and their localizations</u>	<u>Riemann surfaces</u>
“arithmetic holomorphic structures” via rigidifying hyp. curves	complex holomorphic structure on the Riemann surface
the operation of <i>mono-analyticization</i>	passing to the underlying <i>real analytic</i> manifold

Thus, from this point of view, one may think of the

disjoint union of the various  $G_k$ 's,  $k^\times$ 's over the various nonarchimedean and archimedean primes of the number field

as being the “*arithmetic underlying real analytic manifold*” of the “arithmetic Riemann surface” constituted by the number field. Indeed, it is precisely this sort of disjoint union that arises in the theory of mono-analyticization, as developed in §5.

Next, we consider the *effect on log-shells* of the operation of *mono-analyticization*. In the *nonarchimedean* case,

$$\log_{\bar{k}}(\mathcal{O}_k^\times) \cong \mathcal{O}_k^\times / (\text{torsion})$$

may be reconstructed group-theoretically from  $G_k$  as the quotient by torsion of the image of  $I_k$  in the abelianization  $G_k^{\text{ab}}$  (cf. Proposition 5.8, (i), (ii)); a similar construction may be applied to finite extensions  $\subseteq \bar{k}$  of  $k$ . Moreover, this construction involves *only the group of units*  $\mathcal{O}_k^\times$  (i.e., it does not involve the *value groups*, which, as discussed above, are subject to *Teichmüller dilations*), hence is *compatible* with the operation of *mono-analyticization*. Thus, this construction yields a *canonical rigid integral structure*, i.e., in the form of the topological module  $\log_{\bar{k}}(\mathcal{O}_k^\times)$ , which may be thought of as a sort of *approximation* of some nonarchimedean localization of the *trivial global arithmetic line bundle* (cf. Remarks 5.4.2, 5.4.3) that is achieved without the use of (the *two* combinatorial dimensions of) the ring structure on  $\mathcal{O}_k$ . Note, moreover, that the *ring structure* on the perfection  $\log_{\bar{k}}(\mathcal{O}_k^\times)^{\text{Pf}}$  (i.e., in effect, “ $\log_{\bar{k}}(\mathcal{O}_k^\times) \otimes \mathbb{Q}$ ”) of this module is *obliterated* by the operation of mono-analyticization. That is to say, this ring structure is *only accessible within a “zone of arithmetic holomorphy”* (as discussed above). On the other hand,

if one returns to such a zone of arithmetic holomorphy to avail oneself of the ring structure on  $\log_{\bar{k}}(\mathcal{O}_k^\times)^{\text{Pf}}$ , then applying the operation of mono-analyticization amounts to applying the construction discussed above to the *group of units* of  $\log_{\bar{k}}(\mathcal{O}_k^\times)^{\text{Pf}}$  (equipped with the ring structure furnished by the zone of arithmetic holomorphy under consideration). That is to say, the freedom to execute, at will, both the operations of *exiting* and *re-entering* zones of arithmetic holomorphy is *inextricably linked to the “juggling of  $\boxplus$ ,  $\boxtimes$ ” via  $\log$*  (cf. Remark 5.10.2, (ii), (iii)).

In the *archimedean* case, if one writes

$$\log(\mathcal{O}_k^\times) \rightarrow \mathcal{O}_k^\times$$

for the *universal covering topological group* of  $\mathcal{O}_k^\times$  (i.e., in essence, the *exponential map* “ $2\pi i \cdot \mathbb{R} \rightarrow \mathbb{S}^1$ ”), then the surjection  $\log(\mathcal{O}_k^\times) \rightarrow \mathcal{O}_k^\times$  determines on  $\log(\mathcal{O}_k^\times)$  a “canonical rigid line segment of length  $2\pi$ ”. Thus, if one writes  $k = k^{\text{im}} \times k^{\text{rl}}$  for the product decomposition of the additive topological group  $k$  into *imaginary* (i.e., “ $i \cdot \mathbb{R}$ ”) and *real* (i.e., “ $\mathbb{R}$ ”) parts, then we obtain a *natural isometry*

$$\log(\mathcal{O}_k^\times) \times \log(\mathcal{O}_k^\times) \xrightarrow{\sim} k^{\text{im}} \times k^{\text{rl}} = k$$

(i.e., the product of the identity isomorphism  $2\pi i \cdot \mathbb{R} = i \cdot \mathbb{R}$  and the isomorphism  $2\pi i \cdot \mathbb{R} \xrightarrow{\sim} \mathbb{R}$  given by dividing by  $\pm i$ ) which is well-defined up to multiplication by  $\pm 1$  on the *second factors* (cf. Definition 5.6, (iv); Proposition 5.8, (iv), (v)). In particular, “ $\log(\mathcal{O}_k^\times) \times \log(\mathcal{O}_k^\times)$ ” may be regarded as a construction, based on the “*rigid*” topological group  $\mathcal{O}_k^\times$  (which is not subject to *Teichmüller dilations!*), of a *canonical rigid integral structure* (determined by the canonical rigid line segments discussed above) that serves as an approximation of some archimedean localization of the trivial global arithmetic line bundle and, moreover, is compatible with the operation of mono-analyticization (cf. the nonarchimedean case). On the other hand, (as might be expected by comparison to the nonarchimedean case) once one *exits a zone of arithmetic holomorphy*, the  $\pm 1$ -*indeterminacy* that occurs in the above natural isometry has the effect of *obstructing* any attempts to transport the ring structure of  $k$  via this natural isometry so as to obtain a structure of *complex archimedean field* on  $\log(\mathcal{O}_k^\times) \times \log(\mathcal{O}_k^\times)$  (cf. Remark 5.8.1). Finally, just as in the nonarchimedean case, the freedom to execute, at will, both the operations of *exiting* and *re-entering* zones of arithmetic



holomorphy is *inextricably linked to the “juggling of  $\boxplus$ ,  $\boxtimes$ ” via  $\log$*  (cf. Remark 5.10.2, (ii), (iii)) — a phenomenon that is strongly reminiscent of the crucial role played by *rotations* in the theory of mono-analyticizations of archimedean log-shells (cf. Remark 5.8.1).

**§I4. Mono-anabelian Log-Frobenius Compatibility**

Within each zone of arithmetic holomorphy, one wishes to apply the *log-Frobenius functor*  $\log$ . As discussed in §I1,  $\log$  may be thought of as a sort of “wall” that may be *penetrated* by such “elementary combinatorial/topological objects” as *Galois groups* (in the nonarchimedean case) or *underlying topological spaces* (in the archimedean case), but *not by rings or functions* (cf. Remark 3.7.7). This situation suggests a possible analogy with ideas from physics in which “*étale-like*” structures (cf. the Introduction of [Mzk16]), which can *penetrate the  $\log$ -wall*, are regarded as “*massless*”, like *light*, while “*Frobenius-like*” structures (cf. the Introduction of [Mzk16]), which *cannot* penetrate the  $\log$ -wall, are regarded as being of “*positive mass*”, like ordinary matter (cf. Remark 3.7.5, (iii)).

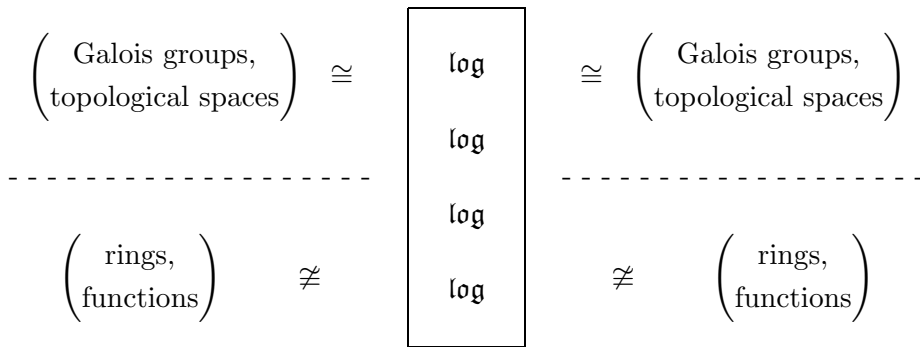

In the archimedean case, since topological spaces alone are not sufficient to transport “holomorphic structures” in the usual sense, we take the approach in §2 of considering “*Aut-holomorphic spaces*”, i.e., underlying topological spaces of Riemann surfaces equipped with the additional data of a *group of “special self-homeomorphisms”* (i.e., bi-holomorphic automorphisms) of each (sufficiently small) open connected subset (cf. Definition 2.1, (i)). The point here is to “*somehow encode the usual notion of a holomorphic*

*structure*” in such a way that one does not need to resort to the use of “*fixed reference models*” of the field of complex numbers  $\mathbb{C}$  (as is done in the conventional definition of a holomorphic structure, which consists of *local comparison* to such a fixed reference model of  $\mathbb{C}$ ), since such models of  $\mathbb{C}$  *fail to be “immune”* to the application of  $\log$  — cf. Remarks 2.1.2, 2.7.4. This situation is very much an *archimedean analogue* of the distinction between *mono-anabelian* and *bi-anabelian* geometry. That is to say, if one thinks of one of the *two* schemes that occur in bi-anabelian comparison results as the “*given scheme of interest*” and the other scheme as a “*fixed reference model*”, then although these two schemes are *related* to one another via purely Galois-theoretic data, the scheme structure of the “*scheme of interest*” is reconstructed from the Galois-theoretic data by *transporting* the scheme structure of “*model scheme*”, hence requires the use of *input data* (i.e., the scheme structure of the “*model scheme*”) that *cannot penetrate the log-wall*.

In order to formalize these ideas concerning the issue of distinguishing between “*model-dependent*”, “*bi-anabelian*” approaches and “*model-independent*”, “*mono-anabelian*” approaches, we take the point of view, in §3, §4, of considering “*series of operations*” — in the form of *diagrams* (parametrized by various *oriented graphs*) of *functors* — applied to various “*types of data*” — in the form of objects of *categories* (cf. Remark 3.6.7). Although, by definition, it is impossible to *compare* the “*different types of data*” obtained by applying these various “*operations*”, if one considers “*projections*” of these operations between different types of data onto morphisms between objects of a single category (i.e., a single “*type of data*”), then such comparisons become possible. Such a “*projection*” is formalized in Definition 3.5, (iii), as the notion of an *observable*. One special type of observable that is of crucial importance in the theory of the present paper is an observable that “*captures a certain portion of various distinct types of data that remains constant, up to isomorphism, throughout the series of operations applied to these distinct types of data*”. Such an observable is referred to as a *core* (cf. Definition 3.5, (iii)). Another important notion in the theory of the present paper is the notion of *telecore* (cf. Definition 3.5, (iv)), which may be thought of as a sort of “*core structure whose compatibility apparatus (i.e., ‘constant nature’) only goes into effect after a certain time lag*” (cf. Remark 3.5.1).

Before explaining how these notions are applied in the situation over *number fields* considered in the present paper, it is useful to consider the analogy between these notions and the *classical p-adic theory*.

The *prototype* of the notion of a *core* is the *constant nature* (i.e., up to equivalence of categories) of the *étale site* of a scheme in positive characteristic with respect to the (operation constituted by the) *Frobenius morphism*.

Put another way, cores may be thought of as corresponding to the notion of “*slope zero*” Galois representations in the *p*-adic theory. By contrast, *telecores* may be thought of as corresponding to the notion of “*positive slope*” in the *p*-adic theory. In particular, the “time lag” inherent in the compatibility apparatus of a telecore may be thought of as corresponding to the “lag”, in terms of powers of *p*, that occurs when one applies *Hensel’s lemma* (cf., e.g., [Mzk21], Lemma 2.1) to lift solutions, modulo various powers of *p*, of a polynomial equation that gives rise to a crystalline Galois representation — e.g., arising from an “ $\mathcal{MF}^\nabla$ -object” of [Falt] — for which the slopes of the Frobenius action are *positive* (cf. Remark 3.6.5 for more on this topic). This formal analogy with the classical *p*-adic theory forms the starting point for the analogy with *p*-adic Teichmüller theory to be discussed in §I5 below (cf. Remark 3.7.2).

Now let us return to the situation involving *k*,  $\bar{k}$ ,  $G_k$ , and  $\log_{\bar{k}}$  discussed at the beginning of §I1. Suppose further that we are given a hyperbolic orbicurve over *k* as in the discussion of §I3, whose étale fundamental group  $\Pi$  surjects onto  $G_k$  (hence may be regarded as acting on  $\bar{k}$ ,  $\bar{k}^\times$ ) and, moreover, satisfies the important property of *rigidifying*  $G_k$  (as discussed in §I3). Then the “*series of operations*” performed in this context may be summarized as follows (cf. Remark 3.7.3, (ii)):

$$\Pi \rightsquigarrow \left( \begin{array}{c} \Pi \\ \curvearrowright \\ \bar{k}_{2\ln}^\times \end{array} \right) \rightsquigarrow \left( \begin{array}{ccc} \Pi & & \\ \curvearrowright & & \\ \bar{k}_\gamma^\times & \curvearrowright & \log \end{array} \right) \rightsquigarrow \Pi \rightsquigarrow \left( \begin{array}{c} \Pi \\ \curvearrowright \\ \bar{k}_{2\ln}^\times \end{array} \right)$$

Here, the various *operations* “ $\rightsquigarrow$ ”, “ $\curvearrowright$ ” may be described in words as follows:

- (O1) One applies the *mono-anabelian reconstruction algorithms* of §1 to  $\Pi$  to construct a “mono-anabelian copy”  $\overline{k}_{\mathfrak{Q}\mathfrak{m}}^\times$  of  $\overline{k}^\times$ . Here,  $\overline{k}_{\mathfrak{Q}\mathfrak{m}}^\times$  is the group of nonzero elements of a field  $\overline{k}_{\mathfrak{Q}\mathfrak{m}}$ . Moreover, it is important to note that  $\overline{k}_{\mathfrak{Q}\mathfrak{m}}$  is equipped with the structure *not* of “some field  $\overline{k}_{\mathfrak{Q}\mathfrak{m}}$  isomorphic to  $\overline{k}$ ”, but rather of “the *specific* field (isomorphic to  $\overline{k}$ ) reconstructed via the mono-anabelian reconstruction algorithms of §1”.
- (O2) One *forgets* the fact that  $\overline{k}_{\mathfrak{Q}\mathfrak{m}}$  arises from the mono-anabelian reconstruction algorithms of §1, i.e., one regards  $\overline{k}_{\mathfrak{Q}\mathfrak{m}}$  just as “some field  $\overline{k}_\gamma$  (isomorphic to  $\overline{k}$ )”.
- (O3) Having performed the operation of (O2), one can now proceed to apply *log-Frobenius operation*  $\mathfrak{log}$  (i.e.,  $\log_{\overline{k}}$ ) to  $\overline{k}_\gamma$ . This operation  $\mathfrak{log}$  may be thought of as the assignment

$$(\Pi \curvearrowright \overline{k}_\gamma^\times) \rightsquigarrow (\Pi \curvearrowright \{\log_{\overline{k}_\gamma}(\mathcal{O}_{\overline{k}_\gamma}^\times)^{\text{pf}}\}^\times)$$

that maps the group of nonzero elements of the topological field  $\overline{k}_\gamma$  to the group of nonzero elements of the topological field “ $\log_{\overline{k}_\gamma}(\mathcal{O}_{\overline{k}_\gamma}^\times)^{\text{pf}}$ ” (cf. the discussion of §I3).

- (O4) One *forgets* all the data except for the profinite group  $\Pi$ .
- (O5) This is the same operation as the operation described in (O1).

With regard to the operation  $\mathfrak{log}$ , observe that if we *forget* the various field or group structures involved, then the arrows

$$\overline{k}_\gamma^\times \leftrightarrow \mathcal{O}_{\overline{k}_\gamma}^\times \rightarrow \log_{\overline{k}_\gamma}(\mathcal{O}_{\overline{k}_\gamma}^\times)^{\text{pf}} \leftrightarrow \{\log_{\overline{k}_\gamma}(\mathcal{O}_{\overline{k}_\gamma}^\times)^{\text{pf}}\}^\times$$

allow one to relate the *input* of  $\mathfrak{log}$  (on the left) to the the *output* of  $\mathfrak{log}$  (on the right). That is to say, in the formalism developed in §3, these arrows may be regarded as defining an *observable* “ $\mathfrak{S}_{\mathfrak{log}}$ ” associated to  $\mathfrak{log}$  (cf. Corollary 3.6, (iii)).

If one allows oneself to reiterate the operation  $\mathbf{log}$ , then one obtains diagrams equipped with a *natural*  $\mathbb{Z}$ -action (cf. Corollary 3.6, (v)). These diagrams equipped with a  $\mathbb{Z}$ -action are reminiscent, at a *combinatorial* level, of the “*arithmetic*  $\mathbb{G}_m$ ’s” that occurred in the discussion of §I3 (cf. Remark 3.6.3).

Next, observe that the operation of “*projecting to  $\Pi$* ” (i.e., forgetting all of the data under consideration except for  $\Pi$ ) is *compatible* with the execution of any of these operations (O1), (O2), (O3), (O4), (O5). That is to say,  $\Pi$  determines a *core* of this collection of operations (cf. Corollary 3.6, (i), (ii), (iii)). Moreover, since the *mono-anabelian reconstruction algorithms* of §1 are “*purely group-theoretic*” and *depend only on the input data constituted by  $\Pi$* , it follows immediately that (by “*projecting to  $\Pi$* ” and then applying these algorithms) “ $(\Pi \curvearrowright \bar{k}_{\mathfrak{A}\mathfrak{n}}^\times)$ ” also forms a *core* of this collection of operations (cf. Corollary 3.6, (i), (ii), (iii)). In particular, we obtain a *natural isomorphism* between the “ $(\Pi \curvearrowright \bar{k}_{\mathfrak{A}\mathfrak{n}}^\times)$ ’s” that occur following the first and fourth “ $\curvearrowright$ ’s” of the above diagram.

On the other hand, the “*forgetting*” operation of (O2) may be thought of as a sort of *section* of the “*projection to the core*  $(\Pi \curvearrowright \bar{k}_{\mathfrak{A}\mathfrak{n}}^\times)$ ”. This sort of section will be referred to as a *telecore*; a telecore frequently comes equipped with an auxiliary structure, called a *contact structure*, which corresponds in the present situation to the isomorphism of underlying fields (stripped of their respective zero elements)  $\bar{k}_{\mathfrak{A}\mathfrak{n}}^\times \xrightarrow{\sim} \bar{k}_\gamma^\times$  (cf. Corollary 3.6, (ii)). Even though the core “ $(\Pi \curvearrowright \bar{k}_{\mathfrak{A}\mathfrak{n}}^\times)$ ”, regarded as an object obtained by projecting, is *constant* (up to isomorphism), the *section* obtained in this way does *not* yield a “*constant*” collection of data (with respect to the operations of the diagram above) that is *compatible* with the observable  $\mathfrak{S}_{\mathbf{log}}$ . Indeed, forgetting the marker “ $\mathfrak{A}\mathfrak{n}$ ” of (the *constant*)  $\bar{k}_{\mathfrak{A}\mathfrak{n}}^\times$  and then applying  $\mathbf{log}$  is *not compatible*, relative to  $\mathfrak{S}_{\mathbf{log}}$ , with forgetting the marker “ $\mathfrak{A}\mathfrak{n}$ ” — i.e., since  $\mathbf{log}$  *obliterates the ring structures* involved (cf. Corollary 3.6, (iv); Remark 3.6.1). Nevertheless, if, subsequent to applying the operations of (O2), (O3), one projects back down to “ $(\Pi \curvearrowright \bar{k}_{\mathfrak{A}\mathfrak{n}}^\times)$ ”, then, as was observed above, one obtains a *natural isomorphism* between the initial and final copies of “ $(\Pi \curvearrowright \bar{k}_{\mathfrak{A}\mathfrak{n}}^\times)$ ”. It is in this sense that one may think of a telecore as a “*core with a time lag*”.

One way to summarize the above discussion is as follows: The “*purely group-theoretic*” *mono-anabelian* reconstruction algorithms of §1 allow one

to construct models of scheme-theoretic data (i.e., the “ $\bar{k}_{\mathfrak{Q}\mathfrak{n}}^\times$ ”) that satisfy the following three *properties* (cf. Remark 3.7.3, (i), (ii)):

- (P1) *coricity* (i.e., the “property of being a core” of “ $\Pi$ ”, “ $(\Pi \curvearrowright \bar{k}_{\mathfrak{Q}\mathfrak{n}}^\times)$ ”);
- (P2) *comparability* (i.e., via the telecore and contact structures discussed above) with *log-subject* copies (i.e., the “ $\bar{k}_\gamma^\times$ ”, which are subject to the action of  $\mathfrak{log}$ );
- (P3) *log-observability* (i.e., via “ $\mathfrak{S}_{\mathfrak{log}}$ ”).

One way to understand better what is gained by this *mono-anabelian* approach is to consider what happens if one takes a *bi-anabelian* approach to this situation (cf. Remarks 3.7.3, (iii), (iv); 3.7.5).

In the bi-anabelian approach, instead of taking just “ $\Pi$ ” as one’s core, one takes the data

$$(\Pi \curvearrowright \bar{k}_{\text{model}}^\times)$$

— where “ $\bar{k}_{\text{model}}^\times$ ” is some *fixed reference model* of  $\bar{k}$  — as one’s *core* (cf. Corollary 3.7, (i)). The *bi-anabelian* version (i.e., fully faithfulness in the style of the “*Grothendieck Conjecture*”) of the mono-anabelian theory of §1 then gives rise to *telecore* and *contact* structures by considering the isomorphism  $\bar{k}_{\text{model}}^\times \xrightarrow{\sim} \bar{k}_\gamma^\times$  arising from an isomorphism between the “ $\Pi$ ’s” that act on  $\bar{k}_{\text{model}}^\times, \bar{k}_\gamma^\times$  (cf. Corollary 3.7, (ii)). Moreover, one may define an *observable* “ $\mathfrak{S}_{\mathfrak{log}}$ ” as in the mono-anabelian case (cf. Corollary 3.7, (iii)). Just as in the mono-anabelian case, since  $\mathfrak{log}$  *obliterates the ring structures* involved, this model  $\bar{k}_{\text{model}}^\times$  *fails to be simultaneously compatible* with the observable  $\mathfrak{S}_{\mathfrak{log}}$  and the telecore and (a slight extension, as described in Corollary 3.7, (ii), of the) contact structures just mentioned (cf. Corollary 3.7, (iv)). On the other hand, whereas in the mono-anabelian case, one may *recover* from this failure of compatibility by projecting back down to “ $\Pi$ ” (which remains *intact!*) and hence to “ $(\Pi \curvearrowright \bar{k}_{\mathfrak{Q}\mathfrak{n}}^\times)$ ”, in the bi-anabelian case, the “ $\bar{k}_{\text{model}}^\times$ ” portion of “the core  $(\Pi \curvearrowright \bar{k}_{\text{model}}^\times)$ ” — which is an *essential* portion of the *input data* for reconstruction algorithms via the *bi-anabelian* approach! (cf. Remarks 3.7.3, (iv); 3.7.5, (ii)) — is *obliterated* by  $\mathfrak{log}$ , thus rendering it *impossible to relate* the “ $(\Pi \curvearrowright \bar{k}_{\text{model}}^\times)$ ’s” *before* and *after* the application of  $\mathfrak{log}$  via an isomorphism that is compatible with all of the operations involved. At a more technical level, the non-existence

of such a natural isomorphism may be seen in the fact that the *coricity* of “ $(\Pi \curvearrowright \overline{k}_{\text{model}}^\times)$ ” is only asserted in Corollary 3.7, (i), for a *certain limited portion* of the diagram involving “all of the operations under consideration” (cf. also the *incompatibilities* of Corollary 3.7, (iv)). This contrasts with the (*manifest!*) *coricity* of “ $\Pi$ ”, “ $(\Pi \curvearrowright \overline{k}_{\mathfrak{Qln}}^\times)$ ” with respect to *all* of the operations under consideration in the mono-anabelian case (cf. Corollary 3.6, (i), (ii), (iii)).

In this context, one important observation is that if one tries to “*subsume*” the model “ $\overline{k}_{\text{model}}^\times$ ” into  $\Pi$  by “*regarding*” this model as an object that “*arises from the sole input data*  $\Pi$ ”, then one must contend with various problems from the point of view of *functoriality* — cf. Remark 3.7.4 for more details on such “*functorially trivial models*”. That is to say, to regard “ $\overline{k}_{\text{model}}^\times$ ” in this way means that one must contend with a situation in which the functorially induced action of  $\Pi$  on “ $\overline{k}_{\text{model}}^\times$ ” is *trivial!*

Finally, we note in passing that the “*dynamics*” of the various diagrams of operations (i.e., functors) appearing in the above discussion are reminiscent of the analogy with physics discussed at the beginning of the present §I4 — i.e., that “ $\Pi$ ” is *massless*, like *light*, while “ $\overline{k}_\gamma^\times$ ” is of *positive mass*.

**§I5. Analogy with  $p$ -adic Teichmüller Theory**

We have already discussed in §I1 the analogy between the *log-Frobenius* operation  $\log$  and the *Frobenius morphism* in positive characteristic. This analogy may be developed further (cf. Remarks 3.6.6, 3.7.2 for more details) into an analogy between the formalism discussed in §I4 and the notion of a *uniformizing*  $\mathcal{MF}^\nabla$ -*object* as discussed in [Mzk1], [Mzk4], i.e., an  $\mathcal{MF}^\nabla$ -object in the sense of [Falt] that gives rise to “*canonical coordinates*” that may be regarded as a sort of  *$p$ -adic uniformization* of the variety under consideration. Indeed, in the notation of §I4, the “*mono-anabelian output data*  $(\Pi \curvearrowright \overline{k}_{\mathfrak{Qln}}^\times)$ ” may be regarded as corresponding to the “*Galois representation*” associated to a structure of “*uniformizing*  $\mathcal{MF}^\nabla$ -*object*” on the *scheme-theoretic* “ $(\Pi \curvearrowright \overline{k}_\gamma^\times)$ ”. The *telecore* structures discussed in §I4 may be regarded as corresponding to a sort of *Hodge filtration*, i.e., an operation relating the “*Frobenius crystal*” under consideration to a *specific scheme theory* “ $(\Pi \curvearrowright \overline{k}_\gamma^\times)$ ”, among the various scheme theories separated from one another by (the *non-ring-homomorphism!*)  $\log$ . The associated *contact* structures then take on an appearance that is formally reminiscent

of the notion of a *connection* in the classical crystalline theory. The *failure* of the  $\log$ -observable, telecore, and contact structures to be *simultaneously compatible* (cf. Corollaries 3.6, (iv); 3.7, (iv)) may then be regarded as corresponding to the fact that, for instance in the case of the uniformizing  $\mathcal{MF}^\nabla$ -objects determined by *indigenous bundles* in [Mzk1], [Mzk4], *the Kodaira-Spencer morphism is an isomorphism* (i.e., the fact that the Hodge filtration *fails* to be a horizontal Frobenius-invariant!).

<u>mono-anabelian theory</u>	<u>p-adic theory</u>
log-Frobenius $\log$	Frobenius
mono-anabelian output data	Frobenius-invariants
telecore structure	Hodge filtration
contact structure	connection
simultaneous incompatibility of $\log$ -observable, telecore, and contact structures	Kodaira-Spencer morphism of an indigenous bundle is an isomorphism

In the context of this analogy, we observe that the *failure* of the logarithms at the various *localizations* of a number field to *extend* to a *global* map involving the number field (cf. Remark 5.4.1) may be regarded as corresponding to the *failure* of various *Frobenius liftings on affine opens* (i.e., localizations) of a hyperbolic curve (over, say, a ring of Witt vectors of a perfect field) to *extend* to a morphism defined (“globally”) on the *entire curve* (cf. [Mzk21], Remark 2.6.2). This lack of a global extension in the  $p$ -adic case means, in particular, that it does not make sense to pull-back arbitrary coherent sheaves on the curve via such Frobenius liftings. On the other hand, if a coherent sheaf on the curve is equipped with the structure of a *crystal*, then a “*global pull-back* of the crystal” is well-defined and “*canonical*”, even though the various local Frobenius liftings used to construct it are not. In a similar way, although the logarithms at localizations of a number field are *not compatible with the ring structures* involved, hence cannot be used to pull-back arbitrary ring/scheme-theoretic objects, they *can* be used to “pull-back” *Galois-theoretic structures*, such as those obtained by



applying *mono-anabelian reconstruction algorithms*.

<u><i>mono-anabelian theory</i></u>	<u><i>p-adic theory</i></u>
<i>logarithms at localizations of a number field</i>	<i>Frobenius liftings on affine opens of a hyperbolic curve</i>
<i>nonexistence of global logarithm on a number field</i>	<i>nonexistence of global Frobenius lifting on a hyperbolic curve</i>
<i>incompatibility of log with ring structures</i>	<i>noncanonicity of local liftings of positive characteristic Frobenius</i>
<i>compatibility of log with Galois, mono-anabelian algorithms</i>	<i>Frobenius pull-back of crystals</i>
<i>the result of forgetting “<math>\mathfrak{A}n</math>” (cf. (O2) of §I3)</i>	<i>the underlying coherent sheaf of a crystal</i>

Moreover, this analogy may be developed even further by specializing from arbitrary uniformizing  $\mathcal{MF}^\nabla$ -objects to the *indigenous bundles* of the *p-adic Teichmüller theory* of [Mzk1], [Mzk4]. To see this, we begin by observing that the *non-rigid dimension* of the *localizations of a number field* “ $G_k$ ”, “ $k^\times$ ” in the discussion of §I3 may be regarded as analogous to the *non-rigidity* of a *p-adic deformation of an affine open* (i.e., a localization) of a hyperbolic curve in positive characteristic. If, on the other hand, such a hyperbolic curve is equipped with the *crystal* determined by a *p-adic indigenous bundle*, then, even if one *restricts to an affine open*, this filtered crystal has the effect of *rigidifying* a specific *p-adic deformation* of this affine open. Indeed, this rigidifying effect is an immediate consequence of the fact that the *Kodaira-Spencer morphism of an indigenous bundle is an isomorphism*. Put another way, this Kodaira-Spencer isomorphism has the effect of allowing the affine open to “*entrust its moduli*” to the crystal determined by the *p-adic indigenous bundle*. This situation is reminiscent of the *rigidifying actions* discussed in §I3 of “ $G_k$ ”, “ $k^\times$ ” on certain geometric data arising from a *hyperbolic orbicurve* that is related to a once-punctured elliptic curve. That is to say, the *mono-anabelian theory* of §1, §2 allows these localizations “ $G_k$ ”, “ $k^\times$ ” of a number field to “*entrust their ring structures*” — i.e.,

their “*arithmetic holomorphic moduli*” — to the hyperbolic orbicurve under consideration. This leads naturally (cf. Remark 5.10.3, (i)) to the analogy already referred to in §11:

<u><i>mono-anabelian theory</i></u>	<u><i>p-adic theory</i></u>
number field $F$	hyperbolic curve $C$ in pos. char.
once-punctured ell. curve $X$ over $F$	nilp. ord. indig. bundle $P$ over $C$

If, moreover, one modifies the *canonical rigid integral structures* furnished by *log-shells* by means of the “*Gaussian zeroes*” (i.e., the inverse of the “*Gaussian poles*”) that appear in the *Hodge-Arakelov theory of elliptic curves* (cf., e.g., [Mzk6], §1.1), then one may further refine the above analogy by regarding *indigenous bundles* as corresponding to the *crystalline theta object* (which may be thought of as an object obtained by equipping a direct sum of trivial line bundles with the integral structures determined by the Gaussian zeroes) of Hodge-Arakelov theory (cf. Remark 5.10.3, (ii)). From this point of view, the mono-anabelian theory of §1, §2, which may be thought of as centering around the technique of *Belyi cuspidalizations*, may be regarded as corresponding to the theory of *indigenous bundles in positive characteristic* (cf. [Mzk1], Chapter II), which centers around the *Verschiebung* on indigenous bundles. Moreover, the theory of the *étale theta function* given in [Mzk18], which centers around the technique of *elliptic cuspidalizations*, may be regarded as corresponding to the theory of the *Frobenius action on square differentials* in [Mzk1], Chapter II. Indeed, just as the technique of elliptic cuspidalizations may be thought of a sort of *linearized, simplified version* of the technique of Belyi cuspidalizations, the Frobenius action on square differentials occurs as the *derivative* (i.e., a “linearized, simplified version”) of the *Verschiebung* on indigenous bundles. For more on this analogy, we refer to Remark 5.10.3. In passing, we observe, relative to the point of view that the theory of the étale theta function given in [Mzk18] somehow represents a “linearized, simplified version” of the mono-anabelian theory of the present paper, that the issue of *mono-* versus *bi-anabelian geometry* discussed in the present paper is vaguely reminiscent of the issue of *mono-* versus *bi-theta environments*, which constitutes a central theme in [Mzk18]. In this context, it is perhaps natural to regard the “*log-wall*” discussed in

§I4 — which forms the principal obstruction to applying the *bi*-anabelian approach in the present paper — as corresponding to the “ $\Theta$ -wall” constituted by the theta function between the *theta* and *algebraic* trivializations of a certain ample line bundle — which forms the principal obstruction to the use of *bi*-theta environments in the theory of [Mzk18].

<u><i>mono-anabelian theory</i></u>	<u><i>p-adic theory</i></u>
<i>crystalline theta objects</i> in scheme-theoretic Hodge-Arakelov theory	scheme-theoretic <i>indigenous bundles</i> (cf. [Mzk1], Chapter I)
<i>Belyi cuspidalizations</i> in mono-anabelian theory of §1	<i>Verschiebung</i> on pos. char. indigenous bundles (cf. [Mzk1], Chapter II)
<i>elliptic cuspidalizations</i> in the theory of the étale theta function (cf. [Mzk18])	<i>Frobenius action</i> on <i>square differentials</i> (cf. [Mzk1], Chapter II)

Thus, in summary, the analogy discussed above may be regarded as an analogy between the theory of the present paper and the *positive characteristic portion* of the theory of [Mzk1]. This “positive characteristic portion” may be regarded as including, in a certain sense, the “liftings modulo  $p^2$  portion” of the theory of [Mzk1] since this “liftings modulo  $p^2$  portion” may be formulated, to a certain extent, in terms of positive characteristic scheme theory. If, moreover, one regards the theory of mono-anabelian log-Frobenius compatibility as corresponding to “Frobenius liftings modulo  $p^2$ ”, then the isomorphism between *Galois groups on both sides of the log-wall* may be thought of as corresponding to the *Frobenius action on differentials* induced by dividing the derivative of such a Frobenius lifting modulo  $p^2$  by  $p$ . This correspondence between Galois groups and differentials is reminiscent of the discussion in [Mzk6], §1.3, §1.4, of the *arithmetic Kodaira-Spencer morphism* that arises from the (scheme-theoretic) Hodge-Arakelov theory of elliptic curves. Finally, from this point of view, it is perhaps natural to regard the *mono-anabelian reconstruction algorithms* of

§1 as corresponding to the procedure of *integrating Frobenius-invariant differentials* so as to obtain *canonical coordinates* (i.e., “ $q$ -parameters” — cf. [Mzk1], Chapter III, §1).

<u><i>mono-anabelian theory</i></u>	<u><i>p-adic theory</i></u>
isomorphism between <i>Galois groups</i> on both sides of <b>log</b> -wall	<i>Frobenius action on differentials</i> arising from $\frac{1}{p}$ -derivative of mod $p^2$ Frobenius lifting
<i>mono-anabelian reconstruction algorithms</i>	<i>construction</i> of can. coords. via <i>integration</i> of Frobenius-invariant differentials

The above discussion prompts the following question:

*Can one further extend the theory given in the present paper to a theory that is analogous to the theory of canonical  $p$ -adic liftings given in [Mzk1], Chapter III?*

It is the intention of the author to pursue the goal of developing such an “*extended theory*” in a future paper. Before proceeding, we note that the analogy of such a theory with the theory of canonical  $p$ -adic liftings of [Mzk1], Chapter III, may be thought of as a sort of  $p$ -adic analogue of the “*geodesic flow*” portion of the “rotations and geodesic flows diagram” of §I3:

<u><i>mono-anabelian theory</i></u>	<u><i>p-adic theory</i></u>
mono-anabelian juggling of present paper, i.e., “ <i>rotations</i> ”	<i>positive characteristic</i> (plus mod $p^2$ ) portion of $p$ -adic Teichmüller theory
future extended theory (?), i.e., “ <i>geodesic flows</i> ”	canonical $p$ -adic liftings in $p$ -adic Teichmüller theory

— that is to say,  $p$ -adic deformations correspond to “*geodesic flows*”, while the positive characteristic theory corresponds to “*rotations*” (i.e., the theory of “*mono-anabelian juggling of  $\boxplus, \boxtimes$  via  $\log$* ” given in the present paper). This point of view is reminiscent of the analogy between the archimedean and nonarchimedean theories discussed in Table 1 of the Introduction to [Mzk14].

In this context, it is interesting to note that this *analogy* between the *mono-anabelian* theory of the present paper and *p-adic Teichmüller* theory is *reminiscent* of various phenomena that appear in earlier papers by the author:

- (A1) In [Mzk10], Theorem 3.6, an *absolute p-adic anabelian* result is obtained for *canonical curves* as in [Mzk1] by applying the *p-adic Teichmüller theory* of [Mzk1]. Thus, in a certain sense (i.e., “Teichmüller  $\implies$  anabelian” as opposed to “anabelian  $\implies$  Teichmüller”), this result goes in the *opposite* direction to the direction of the theory of the present paper. On the other hand, this result of [Mzk10] depends on the analysis in [Mzk9], §2, of the logarithmic special fiber of a  $p$ -adic hyperbolic curve via *absolute anabelian geometry over finite fields*.
- (A2) The *reconstruction of the “additive structure”* via the mono-anabelian algorithms of §1 (cf. the *lemma of Uchida* reviewed in Proposition 1.3), which eventually leads (as discussed above), via the theory of §3, to an abstract analogue of “*Frobenius liftings*” (i.e., in the form of uniformizing  $\mathcal{MF}^\nabla$ -objects) is reminiscent (cf. Remark 5.10.4) of the reconstruction of the “additive structure” in [Mzk21], Corollary 2.9, via an argument analogous to an argument that may be used to show the *non-existence of Frobenius liftings* on  $p$ -adic hyperbolic curves (cf. [Mzk21], Remark 2.9.1).

One way to think about (A1), (A2) is by considering the following chart:

	<u><i>p</i>-adic Teichmüller Theory (applied to anabelian geometry)</u>	<u>Future “Teichmüller-like” Extension (?) of Mono-anabelian Theory</u>
<u>Uchida’s Lemma applied to:</u>	characteristic <i>p</i> special fiber	number fields, mixed char. local fields equipped with an elliptically admissible hyperbolic orbicurve
<u>Deformation Theory:</u>	canonical <i>p</i> -adic Frobenius liftings	analogue of Frobenius liftings in future extension (?) of mono-anabelian theory

Here, the correspondence in the first non-italicized line between hyperbolic curves in positive characteristic equipped with a nilpotent ordinary indigenous bundle and number fields (and their localizations) equipped with an elliptically admissible hyperbolic orbicurve (i.e., a hyperbolic orbicurve closely related to a once-punctured elliptic curve) has already been discussed above; the content of the “*p*-adic Teichmüller theory column” of this chart may be thought of as a summary of the content of (A1); the correspondence between this column and the “extended mono-anabelian theory” column may be regarded as a summary of the preceding discussion. On the other hand, the content of (A2) may be thought of as a sort of “*remarkable bridge*”

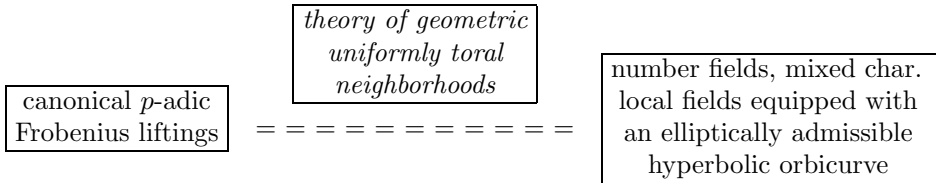

between the upper right-hand and lower left-hand non-italicized entries of the above chart. That is to say, the theory of (A2) (i.e., of *geometric uniformly toral neighborhoods* — cf. [Mzk21], §2) is related to the upper right-hand non-italicized entry of the chart in that, like the application of

“Uchida’s Lemma” represented by this entry, it provides a means for *recovering the ring structure of the base field, given the decomposition groups of the closed points of the hyperbolic orbicurve*. On the other hand, the theory of (A2) (i.e., of [Mzk21], §2) is related to the lower left-hand entry of the chart in that the main result of [Mzk21], §2, is obtained by an argument reminiscent (cf. [Mzk21], Remark 2.6.2; [Mzk21], Remark 2.9.1) of the argument to the effect that *stable curves* over rings of Witt vectors of a perfect field *never admit Frobenius liftings*.

Note, moreover, that from the point of view of the discussion above of “arithmetic holomorphic structures”, this *bridge* may be thought of as a link between the *elementary algebraic approach* to reconstructing the “*two combinatorial dimensions*” of a ring in the fashion of *Uchida’s Lemma* and the “*p-adic differential-geometric approach*” to reconstructing *p-adic ring structures* in the fashion of the theory of [Mzk21], §2. Here, we observe that this “*p-adic differential-geometric approach*” makes essential use of the *hyperbolicity* of the curve under consideration. Indeed, roughly speaking, from the “*Teichmüller-theoretic*” point of view of the present discussion, the argument of the proof of [Mzk21], Lemma 2.6, (ii), may be summarized as follows:

The nonexistence of the desired “*geometric uniformly toral neighborhoods*” may be thought of as a sort of nonexistence of *obstructions* to Teichmüller deformations of the “arithmetic holomorphic structure” that extend in an *unbounded, linear* fashion, like a geodesic flow or *Frobenius lifting*. On the other hand, the *hyperbolicity* of the curve under consideration implies the existence of *topological obstructions* — i.e., in the form of “*loopification*” or “*crushed components*” (cf. [Mzk21], Lemma 2.6, (ii)) — to such “unbounded” deformations of the holomorphic structure. Moreover, such “*compact bounds*” on the deformability of the holomorphic structure are sufficient to “*trap*” the holomorphic structure at a “*canonical point*”, which corresponds to the original holomorphic (i.e., ring) structure of interest.

Put another way, this “*p-adic differential-geometric interpretation of hyperbolicity*” is reminiscent of the dynamics of a *rubber band*, whose *elasticity* implies that even if one tries to stretch the rubber band in an unbounded

fashion, the rubber band ultimately returns to a “*canonical position*”. Moreover, this relationship between hyperbolicity and “elasticity” is reminiscent of the use of the term “*elastic*” in describing certain group-theoretic aspects of hyperbolicity in the theory of [Mzk20], §1, §2.

In passing, we observe that another important aspect of the theory of [Mzk21], §2, in the present context is the use of the *inequality of degrees* obtained by “*differentiating a Frobenius lifting*” (cf. [Mzk21], Remark 2.6.2). The key importance of such degree inequalities in the theory of [Mzk21], §2, suggests, relative to the above chart, that the analogue of such degree inequalities in the theory of “the analogue of Frobenius liftings in a future extension of the mono-anabelian theory” could give rise to results of substantial interest in the *arithmetic of number fields*. The author hopes to address this topic in more detail in a future paper.

Finally, we close the present Introduction to the present paper with some historical remarks. We begin by considering the following *historical facts*:

- (H1) *O. Teichmüller*, in his relatively short career as a mathematician, made contributions *both* to “*complex Teichmüller theory*” and to the theory of *Teichmüller representatives* of Witt rings — two subjects that, at first glance, appear entirely unrelated to one another.
- (H2) In the Introduction to [Ih], *Y. Ihara* considers the issue of obtaining canonical  $p$ -adic liftings of certain positive characteristic hyperbolic curves equipped with a correspondence in a fashion analogous to the *Serre-Tate theory of canonical liftings of abelian varieties*.

These two facts may be regarded as *interesting precursors* of the  $p$ -adic Teichmüller theory of [Mzk1], [Mzk4]. Indeed, the  $p$ -adic Teichmüller theory of [Mzk1], [Mzk4] may be regarded, on the one hand, as an analogue for hyperbolic curves of the Serre-Tate theory of canonical liftings of abelian varieties and, on the other hand, as a  $p$ -adic analogue of complex Teichmüller theory; moreover, the canonical liftings obtained in [Mzk1], [Mzk4] are, literally, “hyperbolic curve versions of Teichmüller representatives in Witt rings”. In fact, one may even go one step further to speculate that perhaps the existence of analogous complex and  $p$ -adic versions of “Teichmüller theory” should be regarded as *hinting of a deeper abstract, combinatorial version*



of “Teichmüller theory” — in a fashion that is perhaps reminiscent of the relationship of the notion of a *motive* to various complex or  $p$ -adic cohomology theories. It is the hope of the author that a possible “*future extended theory*” as discussed above — i.e., a sort of “*Teichmüller theory for number fields equipped with a once-punctured elliptic curve*” — might prove to be just such a “Teichmüller theory”.

*Acknowledgements.* I would like to thank *Yuichiro Hoshi*, *Fumiharu Kato*, *Akio Tamagawa*, and *Go Yamashita* for countless stimulating discussions concerning the material presented in this paper and *Minhyong Kim* and *Ben Moonen* for stimulating questions related to certain of the ideas presented in this paper. Also, I feel most indebted to *Yuichiro Hoshi*, *Go Yamashita*, and *Mohamed Saïdi* for their meticulous reading of and numerous comments concerning the present paper. Finally, I would like to thank *Ivan Fesenko* for his comments concerning the present paper.

## Section 0. Notations and Conventions

We shall continue to use the “Notations and Conventions” of [Mzk20], §0; [Mzk21], §0. In addition, we shall use the following notation and conventions:

### Numbers:

In addition to the “*field types*” NF, MLF, FF introduced in [Mzk20], §0, we shall also consider the following field types:  $A(n)$  *complex archimedean field* (respectively, *real archimedean field*; *archimedean field*), or *CAF* (respectively, *RAF*; *AF*), is defined to be a topological field that is isomorphic to the field of complex numbers (respectively, the field of real numbers; either the field of real numbers or the field of complex numbers). One verifies immediately that any continuous homomorphism between CAF’s (respectively, RAF’s) is, in fact, an *isomorphism of topological fields*.

### Combinatorics:

Let  $E$  be a *partially ordered set*. Then (cf. [Mzk16], §0) we shall denote by

$$\text{Order}(E)$$

the category whose *objects* are elements  $e \in E$ , and whose *morphisms*  $e_1 \rightarrow e_2$  (where  $e_1, e_2 \in E$ ) are the relations  $e_1 \leq e_2$ . A subset  $E' \subseteq E$  will

be called *orderwise connected* if for every  $c \in E$  such  $a < c < b$  for some  $a, b \in E'$ , it follows that  $c \in E'$ .

A partially ordered set which is isomorphic (as a partially ordered set) to an orderwise connected subset of the set of rational integers  $\mathbb{Z}$ , equipped with its usual ordering, will be referred to as a *countably ordered set*. If  $E$  is a countably ordered set, then any choice of an isomorphism of  $E$  with an orderwise connected subset  $E' \subseteq \mathbb{Z}$  allows one to define (in a fashion independent of the choice of  $E'$ ), for *non-maximal* (respectively, *non-minimal*)  $e \in E$  (i.e.,  $e$  such that there exists an  $f \in E$  that is  $> e$  (respectively,  $< e$ )), an element “ $e + 1$ ” (respectively, “ $e - 1$ ”) of  $E$ . Pairs of elements of  $E$  of the form  $(e, e + 1)$  will be referred to as *adjacent*.

An *oriented graph*  $\vec{\Gamma}$  is a graph  $\Gamma$ , which we shall refer to as the *underlying graph* of  $\vec{\Gamma}$ , equipped with the additional data of a total ordering, for each edge  $e$  of  $\Gamma$ , on the set (of cardinality 2) of *branches* of  $e$  (cf., e.g., [Mzk13], the discussion at the beginning of §1, for a definition of the terms “graph”, “branch”). In this situation, we shall refer to the vertices, edges, and branches of  $\Gamma$  as vertices, edges, and branches of  $\vec{\Gamma}$ ; write  $\mathbb{V}(\vec{\Gamma})$ ,  $\mathbb{E}(\vec{\Gamma})$ ,  $\mathbb{B}(\vec{\Gamma})$ , respectively, for the sets of vertices, edges, and branches of  $\vec{\Gamma}$ . Also, whenever  $\Gamma$  satisfies a property of graphs (such as “*finiteness*”), we shall say that  $\vec{\Gamma}$  satisfies this property. We shall refer to the oriented graph  $\vec{\Gamma}^{\text{opp}}$  obtained from  $\vec{\Gamma}$  by *reversing* the ordering on the branches of each edge as the *opposite oriented graph* to  $\vec{\Gamma}$ . A *morphism of oriented graphs* is defined to be a morphism of the underlying graphs (cf., e.g., [Mzk13], §1, the discussion at the beginning of §1) that is compatible with the orderings on the edges. Note that any *countably ordered set*  $E$  may be regarded as an *oriented graph* — i.e., whose vertices are the elements of  $E$ , whose edges are the pairs of adjacent elements of  $E$ , and whose branches are equipped with the (total) ordering induced by the ordering of  $E$ . We shall refer to an oriented graph that arises from a countably ordered set as *linear*. We shall refer to the vertex of a linear oriented graph  $\vec{\Gamma}$  determined by a *minimal* (respectively, *maximal*) element of the corresponding countably ordered set as the *minimal vertex* (respectively, *maximal vertex*) of  $\vec{\Gamma}$ .

Let  $\vec{\Gamma}$  be an *oriented graph*. Then we shall refer to as a *pre-path (of length  $n$ )* (where  $n \geq 0$  is an integer) on  $\vec{\Gamma}$  a morphism  $\gamma : \vec{\Gamma}_\gamma \rightarrow \vec{\Gamma}$ , where  $\vec{\Gamma}_\gamma$  is a *finite linear oriented graph* with precisely  $n$  edges; we shall refer to as a *path (of length  $n$ )* on  $\vec{\Gamma}$  any isomorphism class  $[\gamma]$  in the category of

oriented graphs over  $\vec{\Gamma}$  of a pre-path  $\gamma$  (of length  $n$ ). Write

$$\Omega(\vec{\Gamma})$$

for the set (i.e., since we are working with *isomorphism classes!*) of paths on  $\vec{\Gamma}$ . If  $\gamma : \vec{\Gamma}_\gamma \rightarrow \vec{\Gamma}$  is a pre-path on  $\vec{\Gamma}$ , then we shall refer to the image of the minimal (respectively, maximal) vertex of  $\vec{\Gamma}_\gamma$  as the *initial* (respectively, *terminal*) vertex of  $\gamma$ ,  $[\gamma]$ . Two (pre-)paths with the same initial (respectively, terminal; initial and terminal) vertices will be referred to as *co-initial* (respectively, *co-terminal*; *co-verticial*). If  $\gamma_1, \gamma_2$  are pre-paths on  $\vec{\Gamma}$  such the initial vertex of  $\gamma_2$  is equal to the terminal vertex of  $\gamma_1$ , then one may form the *composite pre-path*  $\gamma_2 \circ \gamma_1$  (in the evident sense), as well as the *composite path*  $[\gamma_2] \circ [\gamma_1] \stackrel{\text{def}}{=} [\gamma_2 \circ \gamma_1]$ . Thus, the length of  $\gamma_2 \circ \gamma_1$  is equal to the sum of the lengths of  $\gamma_1, \gamma_2$ .

Next, let

$$E \subseteq \Omega(\vec{\Gamma}) \times \Omega(\vec{\Gamma})$$

be a *set of ordered pairs of paths* on an oriented graph  $\vec{\Gamma}$ . Then we shall say that  $E$  is *saturated* if the following conditions are satisfied:

- (a) (*Partial Inclusion of the Diagonal*) If  $([\gamma_1], [\gamma_2]) \in E$ , then  $E$  contains  $([\gamma_1], [\gamma_1])$  and  $([\gamma_2], [\gamma_2])$ .
- (b) (*Co-verticiality*) If  $([\gamma_1], [\gamma_2]) \in E$ , then  $[\gamma_1], [\gamma_2]$  are *co-verticial*.
- (c) (*Transitivity*) If  $([\gamma_1], [\gamma_2]) \in E$  and  $([\gamma_2], [\gamma_3]) \in E$ , then  $([\gamma_1], [\gamma_3]) \in E$ .
- (d) (*Pre-composition*) If  $([\gamma_1], [\gamma_2]) \in E$  and  $[\gamma_3] \in \Omega(\vec{\Gamma})$ , then  $([\gamma_1] \circ [\gamma_3], [\gamma_2] \circ [\gamma_3]) \in E$ , whenever these composite paths are defined.
- (e) (*Post-composition*) If  $([\gamma_1], [\gamma_2]) \in E$  and  $[\gamma_3] \in \Omega(\vec{\Gamma})$ , then  $([\gamma_3] \circ [\gamma_1], [\gamma_3] \circ [\gamma_2]) \in E$ , whenever these composite paths are defined.

We shall say that  $E$  is *symmetrically saturated* if  $E$  is saturated and, moreover, satisfies the following condition:

- (f) (*Reflexivity*) If  $([\gamma_1], [\gamma_2]) \in E$ , then  $([\gamma_2], [\gamma_1]) \in E$ .

Thus, the set of all *co-verticial* pairs of paths

$$\text{Covert}(\vec{\Gamma}) \subseteq \Omega(\vec{\Gamma}) \times \Omega(\vec{\Gamma})$$

is *symmetrically saturated*. Moreover, the property of being saturated (respectively, symmetrically saturated) is closed with respect to forming *arbitrary intersections* of subsets of  $\Omega(\vec{\Gamma}) \times \Omega(\vec{\Gamma})$ . In particular, given any subset  $E \subseteq \text{Covert}(\vec{\Gamma})$ , it makes sense to speak of the *saturation* (respectively, *symmetric saturation*) of  $E$  — i.e., the smallest saturated (respectively, symmetrically saturated) subset of  $\text{Covert}(\vec{\Gamma})$  containing  $E$ .

Let  $\vec{\Gamma}$  be an *oriented graph*. Then we shall refer to a vertex  $v$  of  $\vec{\Gamma}$  as a *nexus* of  $\vec{\Gamma}$  if the following conditions are satisfied: (a) the oriented graph  $\vec{\Gamma}_v$  obtained by removing from  $\vec{\Gamma}$  the vertex  $v$ , together with all of the edges that abut to  $v$ , decomposes as a disjoint union of *two nonempty oriented graphs*  $\vec{\Gamma}_{<v}, \vec{\Gamma}_{>v}$ ; (b) every edge of  $\vec{\Gamma}$  that is not contained in  $\vec{\Gamma}_v$  either runs from a vertex of  $\vec{\Gamma}_{<v}$  to  $v$  or from  $v$  to a vertex of  $\vec{\Gamma}_{>v}$ . In this situation, we shall refer to the oriented subgraph  $\vec{\Gamma}_{\leq v}$  (respectively,  $\vec{\Gamma}_{\geq v}$ ) consisting of  $v, \vec{\Gamma}_{<v}$  (respectively,  $\vec{\Gamma}_{>v}$ ), and all of the edges of  $\vec{\Gamma}$  that run to (respectively, emanate from)  $v$  as the *pre-nexus portion* (respectively, *post-nexus portion*) of  $\vec{\Gamma}$ .

**Categories:**

Let  $\mathcal{C}, \mathcal{C}'$  be categories. Then we shall use the notation

$$\text{Ob}(\mathcal{C}); \quad \text{Arr}(\mathcal{C})$$

to denote, respectively, the *objects* and *arrows* of  $\mathcal{C}$ . We shall refer to a functor  $\phi : \mathcal{C} \rightarrow \mathcal{C}'$  as *rigid* if every automorphism of  $\phi$  is equal to the identity (cf. [Mzk16], §0). If the identity functor of  $\mathcal{C}$  is rigid, then we shall say that  $\mathcal{C}$  is *id-rigid*.

Let  $\mathcal{C}$  be a category and  $\vec{\Gamma}$  an oriented graph. Then we shall refer to as a  $\vec{\Gamma}$ -*diagram*  $\{A_v, \phi_e\}$  in  $\mathcal{C}$  a collection of data as follows:

- (a) for each  $v \in \mathbb{V}(\vec{\Gamma})$ , an object  $A_v$  of  $\mathcal{C}$ ;
- (b) for each  $e \in \mathbb{E}(\vec{\Gamma})$  that runs from  $v_1 \in \mathbb{V}(\vec{\Gamma})$  to  $v_2 \in \mathbb{V}(\vec{\Gamma})$ , a morphism  $\phi_e : A_{v_1} \rightarrow A_{v_2}$  of  $\mathcal{C}$ .

A morphism  $\{A_v, \phi_e\} \rightarrow \{A'_v, \phi'_e\}$  of  $\vec{\Gamma}$ -diagrams in  $\mathcal{C}$  is defined to be a collection of morphisms  $\psi_v : A_v \rightarrow A'_v$  for each vertex  $v$  of  $\vec{\Gamma}$  that are compatible with the  $\phi_e, \phi'_e$ . We shall refer to an  $\vec{\Gamma}$ -diagram in  $\mathcal{C}$  as *commutative*

if the composite morphisms determined by any co-vertical pair of paths on  $\vec{\Gamma}$  coincide. Write

$$\mathcal{C}[\vec{\Gamma}]$$

for the category of commutative  $\vec{\Gamma}$ -diagrams in  $\mathcal{C}$  and morphisms of  $\vec{\Gamma}$ -diagrams in  $\mathcal{C}$ .

If  $\mathcal{C}_1, \mathcal{C}_2$ , and  $\mathcal{D}$  are *categories*, and

$$\Phi_1 : \mathcal{C}_1 \rightarrow \mathcal{D}; \quad \Phi_2 : \mathcal{C}_2 \rightarrow \mathcal{D}$$

are *functors*, then we define the “*categorical fiber product*” (cf. [Mzk16], §0)

$$\mathcal{C}_1 \times_{\mathcal{D}} \mathcal{C}_2$$

of  $\mathcal{C}_1, \mathcal{C}_2$  over  $\mathcal{D}$  to be the *category* whose *objects* are triples

$$(A_1, A_2, \alpha : \Phi_1(A_1) \xrightarrow{\sim} \Phi_2(A_2))$$

where  $A_i \in \text{Ob}(\mathcal{C}_i)$  (for  $i = 1, 2$ ),  $\alpha$  is an isomorphism of  $\mathcal{D}$ ; and whose *morphisms*

$$(A_1, A_2, \alpha : \Phi_1(A_1) \xrightarrow{\sim} \Phi_2(A_2)) \rightarrow (B_1, B_2, \beta : \Phi_1(B_1) \xrightarrow{\sim} \Phi_2(B_2))$$

are pairs of morphisms  $\gamma_i : A_i \rightarrow B_i$  (in  $\mathcal{C}_i$ , for  $i = 1, 2$ ) such that  $\beta \circ \Phi_1(\gamma_1) = \Phi_2(\gamma_2) \circ \alpha$ . One verifies easily that if  $\Phi_2$  is an *equivalence*, then the *natural projection functor*  $\mathcal{C}_1 \times_{\mathcal{D}} \mathcal{C}_2 \rightarrow \mathcal{C}_1$  is also an *equivalence*.

We shall use the prefix “ind-” (respectively, “pro-”) to mean, strictly speaking, a(n) inductive (respectively, projective) system indexed by an ordered set isomorphic to the positive (respectively, negative) integers, with their usual ordering. To simplify notation, however, we shall often denote “ind-objects” via the corresponding “limit objects”, when there is no fear of confusion.

Let  $\mathcal{C}$  be a *category*. Then we shall refer to a pair  $(S, A)$ , where  $S \in \text{Ob}(\mathcal{C})$ , and  $A \subseteq \text{Aut}_{\mathcal{C}}(S)$  is a subgroup, as a *pre-orbi-object* of  $\mathcal{C}$ . (Thus, we think of the pair  $(S, A)$  as representing the “*stack-theoretic quotient of S by A*”.) A *morphism of pre-orbi-objects*  $(S_1, A_1) \rightarrow (S_2, A_2)$  is an  $A_2$ -orbit of morphisms  $S_1 \rightarrow S_2$  (relative to the action of  $A_2$  on the codomain) that is closed under the action of  $A_1$  (on the domain). We shall refer to as an *orbi-object*

$$\{(S_l, A_l); \alpha_{l,l'}\}_{l,l' \in I}$$

any collection of data consisting of pre-orbi-objects  $(S_\iota, A_\iota)$ , which we shall refer to as *representatives* (of the given orbi-object), together with “*gluing isomorphisms*”  $\alpha_{\iota, \iota'} : (S_\iota, A_\iota) \xrightarrow{\sim} (S_{\iota'}, A_{\iota'})$  of pre-orbi-objects satisfying the cocycle conditions  $\alpha_{\iota, \iota''} = \alpha_{\iota', \iota''} \circ \alpha_{\iota, \iota'}$ , for  $\iota, \iota', \iota'' \in I$ . A *morphism of orbi-objects* is defined to be a collection of morphisms of pre-orbi-objects from each representative of the domain to each representative of the codomain which are compatible with the gluing isomorphisms. The *category of orbi-objects associated to  $\mathcal{C}$*  is the category — which we shall denote

$$\text{Orb}(\mathcal{C})$$

— whose *objects* are the orbi-objects of  $\mathcal{C}$ , and whose *morphisms* are the morphisms of orbi-objects. Thus, an object may be regarded as a pre-orbi-object whose group of automorphisms is trivial; a pre-orbi-object may be regarded as an orbi-object with precisely one representative. In particular, we obtain a *natural functor*

$$\mathcal{C} \rightarrow \text{Orb}(\mathcal{C})$$

which is “*functorial*” (in the evident sense) with respect to  $\mathcal{C}$ .

## Section 1. Galois-theoretic Reconstruction Algorithms

In the present §1, we apply the technique of *Belyi cuspidalization* developed in [Mzk21], §3, to give a *group-theoretic reconstruction algorithm* (cf. Theorem 1.9, Corollary 1.10) for hyperbolic orbicurves of *strictly Belyi type* (cf. [Mzk21], Definition 3.5) over *sub- $p$ -adic fields* that is *compatible* with base-change of the base field. In the case of *function fields*, this reconstruction algorithm reduces to a *much more elementary algorithm* (cf. Theorem 1.11), which is valid over somewhat more general base fields, namely base fields which are “*Kummer-faithful*” (cf. Definition 1.5).

Let  $X$  be a *hyperbolic curve* over a *field  $k$* . Write  $K_X$  for the *function field* of  $X$ . Then the content of following result is a consequence of the well-known theory of *divisors on algebraic curves*.

**PROPOSITION 1.1** (Review of Linear Systems). *Suppose that  $X$  is proper, and that  $k$  is algebraically closed. Write  $\text{Div}(f)$  for the divisor*

(of zeroes minus poles on  $X$ ) of  $f \in K_X$ . If  $E$  is a divisor on  $X$ , then let us write

$$\Gamma^\times(E) \stackrel{\text{def}}{=} \{f \in K_X \mid \text{Div}(f) + E \geq 0\}$$

(where we use the notation “ $(-) \geq 0$ ” to denote the effectivity of the divisor “ $(-)$ ”),  $l(E) \stackrel{\text{def}}{=} \dim_k(\Gamma(X, \mathcal{O}_X(E)))$ . Let  $D$  be a divisor on  $X$ . Then:

(i)  $\Gamma^\times(D)$  admits a natural free action by  $k^\times$  whenever it is nonempty; there is a natural bijection  $\Gamma^\times(D) \xrightarrow{\sim} \Gamma(X, \mathcal{O}_X(D)) \setminus \{0\}$  that is compatible with the  $k^\times$ -actions on either side, whenever the sets of the bijection are nonempty.

(ii) The integer  $l(D) \geq 0$  is equal to the smallest nonnegative integer  $d$  such that there exists an effective divisor  $E$  of degree  $d$  on  $X$  for which  $\Gamma^\times(D - E) = \emptyset$ . In particular,  $l(D) = 0$  if and only if  $\Gamma^\times(D) = \emptyset$ .

PROPOSITION 1.2 (Additive Structure via Linear Systems). Let  $X, k$  be as in Proposition 1.1. Then:

(i) There exist distinct points  $x, y_1, y_2 \in X(k)$ , together with a divisor  $D$  on  $X$  such that  $x, y_1, y_2 \notin \text{Supp}(D)$  (where we write  $\text{Supp}(D)$  for the support of  $D$ ), such that  $l(D) = 2$ ,  $l(D - E) = 0$ , for any effective divisor  $E = e_1 + e_2$ , where  $e_1 \neq e_2$ ,  $\{e_1, e_2\} \subseteq \{x, y_1, y_2\}$ .

(ii) Let  $x, y_1, y_2, D$  be as in (i). Then for  $i = 1, 2$ ,  $\lambda \in k^\times$ , there exists a unique element  $f_{\lambda,i} \in \Gamma^\times(D) \subseteq K_X$  such that  $f_{\lambda,i}(x) = \lambda$ ,  $f_{\lambda,i}(y_i) \neq 0$ ,  $f_{\lambda,i}(y_{3-i}) = 0$ .

(iii) Let  $x, y_1, y_2, D$  be as in (i);  $\lambda, \mu \in k^\times$  such that  $\lambda/\mu \neq -1$ ;  $f_{\lambda,1} \in \Gamma^\times(D) \subseteq K_X$ ,  $f_{\mu,2} \in \Gamma^\times(D) \subseteq K_X$  as in (ii). Then

$$f_{\lambda,1} + f_{\mu,2} \in \Gamma^\times(D) \subseteq K_X$$

may be characterized as the unique element  $g \in \Gamma^\times(D) \subseteq K_X$  such that  $g(y_1) = f_{\lambda,1}(y_1)$ ,  $g(y_2) = f_{\mu,2}(y_2)$ . In particular, in this situation, the element  $\lambda + \mu \in k^\times$  may be characterized as the element  $g(x) \in k^\times$ .

PROOF. First, we consider assertion (i). Let  $D$  be any divisor on  $X$  such that  $l(D) \geq 2$ . By subtracting an appropriate effective divisor from  $D$ , we may assume that  $l(D) = 2$ . Then take  $x \in X(k) \setminus \text{Supp}(D)$  to be any point such that  $\mathcal{O}_X(D)$  admits a global section that does not vanish at  $x$  (so  $l(D - x) = 1$ ); take  $y_1 \in X(k) \setminus (\text{Supp}(D) \cup \{x\})$  to be any

point such that  $\mathcal{O}_X(D - x)$  admits a global section that does not vanish at  $y_1$  (so  $l(D - x - y_1) = 0$ , which implies that  $l(D - y_1) = 1$ ); take  $y_2 \in X(k) \setminus (\text{Supp}(D) \cup \{x, y_1\})$  to be any point such that  $\mathcal{O}_X(D - x), \mathcal{O}_X(D - y_1)$  admit global sections that do not vanish at  $y_2$  (so  $l(D - x - y_2) = l(D - y_1 - y_2) = 0$ ). This completes the proof of assertion (i). Now assertions (ii), (iii) follow immediately from assertion (i).  $\square$

The following *reconstruction of the additive structure from divisors and rational functions* is implicit in the argument of [Uchi], §3, Lemmas 8-11 (cf. also [Tama], Lemma 4.7).

PROPOSITION 1.3 (Additive Structure via Valuation and Evaluation Maps). *Let  $X, k$  be as in Proposition 1.1. Then there exists a functorial algorithm for constructing the additive structure on  $K_X^\times \cup \{0\}$  (i.e., arising from the field structure of  $K_X$ ) from the following data:*

- (a) the (abstract!) group  $K_X^\times$ ;
- (b) the set of (surjective) homomorphisms

$$\mathcal{V}_X \stackrel{\text{def}}{=} \{\text{ord}_x : K_X^\times \rightarrow \mathbb{Z}\}_{x \in X(k)}$$

(so we have a natural bijection  $\mathcal{V}_X \xrightarrow{\sim} X(k)$ ) that arise as valuation maps associated to points  $x \in X(k)$ ;

- (c) for each homomorphism  $v = \text{ord}_x \in \mathcal{V}_X$ , the subgroup  $\mathcal{U}_v \subseteq K_X^\times$  given by the  $f \in K_X^\times$  such that  $f(x) = 1$ .

Here, the term “functorial” is with respect to isomorphisms (in the evident sense) of such triples (i.e., consisting of a group, a set of homomorphisms from the group to  $\mathbb{Z}$ , and a collection of subgroups of the group parametrized by elements of this set of homomorphisms) arising from proper hyperbolic curves (i.e., “ $X$ ”) over algebraically closed fields (i.e., “ $k$ ”).

PROOF. Indeed, first we observe that  $k^\times \subseteq K_X^\times$  may be constructed as the intersection  $\bigcap_{v \in \mathcal{V}_X} \text{Ker}(v)$ . Since, for  $v \in \mathcal{V}_X$ , we have a *direct product decomposition*  $\text{Ker}(v) = \mathcal{U}_v \times k^\times$ , the projection to  $k^\times$  allows us to “evaluate” elements of  $\text{Ker}(v)$  (i.e., “functions that are invertible at the point associated to  $v$ ”), so as to obtain “values” of such elements  $\in k^\times$ . Next, let us observe that the set of homomorphisms  $\mathcal{V}_X$  of (b) allows one to speak of *divisors*



and *effective divisors* associated to (the abstract group)  $K_X^\times$  of (a). If  $D$  is a divisor associated to  $K_X^\times$ , then we may *define*  $\Gamma^\times(D)$  as in Proposition 1.1, and hence *compute* the integer  $l(D)$  as in Proposition 1.1, (ii). In particular, it makes sense to speak of data as in Proposition 1.2, (i), associated to the abstract data (a), (b), (c). Thus, by *evaluating* elements of various  $\text{Ker}(v)$ , for  $v \in \mathcal{V}_X$ , we may apply the *characterizations* of Proposition 1.2, (ii), (iii), to construct the *additive structure* of  $k^\times$ , hence also the *additive structure* of  $K_X^\times$  (i.e., by “evaluating” at various  $v \in \mathcal{V}_X$ ).  $\square$

REMARK 1.3.1. Note that if  $G$  is an abstract group, then the datum of a *surjection*  $v : G \twoheadrightarrow \mathbb{Z}$  may be thought of as the datum of a *subgroup*  $H \stackrel{\text{def}}{=} \text{Ker}(v)$ , together with the datum of a *choice of generator* of the quotient group  $G/H \xrightarrow{\sim} \mathbb{Z}$ .

PROPOSITION 1.4 (Synchronization of Geometric Cyclotomes). *Suppose that  $X$  is proper, and that  $k$  is of characteristic zero. If  $U \subseteq X$  is a nonempty open subscheme, then we have a natural exact sequence of profinite groups*

$$1 \rightarrow \Delta_U \rightarrow \Pi_U \rightarrow G_k \rightarrow 1$$

— where we write  $\Pi_U \stackrel{\text{def}}{=} \pi_1(U) \rightarrow G_k \stackrel{\text{def}}{=} \pi_1(\text{Spec}(k))$  for the natural surjection of étale fundamental groups (relative to some choice of basepoints),  $\Delta_U$  for the kernel of this surjection. Then:

(i) Let  $U \subseteq X$  be a nonempty open subscheme,  $x \in X(k) \setminus U(k)$ ,  $U_x \stackrel{\text{def}}{=} X \setminus \{x\} \subseteq X$ . Then the inertia group  $I_x$  of  $x$  in  $\Delta_U$  is naturally isomorphic to  $\widehat{\mathbb{Z}}(1)$ ; the kernels of the natural surjections  $\Delta_U \twoheadrightarrow \Delta_{U_x}$ ,  $\Pi_U \twoheadrightarrow \Pi_{U_x}$  are topologically normally generated by the inertia groups of points of  $U_x \setminus U$  (each of which is naturally isomorphic to  $\widehat{\mathbb{Z}}(1)$ ).

(ii) Let  $x, U_x$  be as in (i). Then we have a natural exact sequence of profinite groups

$$1 \rightarrow I_x \rightarrow \Delta_{U_x}^{\text{c-cn}} \rightarrow \Delta_X \rightarrow 1$$

— where we write  $\Delta_{U_x} \twoheadrightarrow \Delta_{U_x}^{\text{c-cn}}$  for the maximal cuspidally central quotient of  $\Delta_{U_x}$  (i.e., the maximal intermediate quotient  $\Delta_{U_x} \twoheadrightarrow Q \twoheadrightarrow \Delta_X$  such that  $\text{Ker}(Q \twoheadrightarrow \Delta_X)$  lies in the center of  $Q$  — cf. [Mzk19], Definition 1.1, (i)). Moreover, applying the differential of the “ $E_2$ -term” of the Leray spectral sequence associated to this group extension to the element

$$1 \in \widehat{\mathbb{Z}} = \text{Hom}(I_x, I_x) = H^0(\Delta_X, H^1(I_x, I_x))$$

yields an element  $\in H^2(\Delta_X, H^0(I_x, I_x)) = \text{Hom}(M_X, I_x)$ , where we write

$$M_X \stackrel{\text{def}}{=} \text{Hom}(H^2(\Delta_X, \widehat{\mathbb{Z}}), \widehat{\mathbb{Z}})$$

(cf. the discussion at the beginning of [Mzk19], §1); this last element corresponds to the natural isomorphism

$$M_X \xrightarrow{\sim} I_x$$

(relative to the well-known natural identifications of  $I_x, M_X$  with  $\widehat{\mathbb{Z}}(1)$  — cf., e.g., (i) above; [Mzk19], Proposition 1.2, (i)). In particular, this yields a “purely group-theoretic algorithm” (cf. Remark 1.9.8 below for more on the meaning of this terminology) for constructing this isomorphism from the surjection  $\Delta_{U_x} \twoheadrightarrow \Delta_X$ .

PROOF. Assertion (i) is well-known (and easily verified from the definitions). Assertion (ii) follows immediately from [Mzk19], Proposition 1.6, (iii).  $\square$

DEFINITION 1.5. Let  $k$  be a field of characteristic zero,  $\bar{k}$  an algebraic closure of  $k$ ,  $G_k \stackrel{\text{def}}{=} \text{Gal}(\bar{k}/k)$ . Then we shall say that  $k$  is *Kummer-faithful* (respectively, *torally Kummer-faithful*) if, for every finite extension  $k_H \subseteq \bar{k}$  of  $k$ , where we write  $H \stackrel{\text{def}}{=} \text{Gal}(\bar{k}/k_H) \subseteq G_k$ , and every *semi-abelian variety* (respectively, every *torus*)  $A$  over  $k_H$ , either of the following two equivalent conditions is satisfied:

(a) We have

$$\bigcap_{N \geq 1} N \cdot A(k_H) = \{0\}$$

— where  $N$  ranges over the positive integers.

(b) The *associated Kummer map*  $A(k_H) \rightarrow H^1(H, \text{Hom}(\mathbb{Q}/\mathbb{Z}, A(\bar{k})))$  is an *injection*.

(To verify the equivalence of (a) and (b), it suffices to consider, on the étale site of  $\text{Spec}(k_H)$ , the long exact sequences in étale cohomology associated to the exact sequences  $0 \rightarrow N A \rightarrow A \xrightarrow{N} A \rightarrow 0$  arising from multiplication by positive integers  $N$ .)

REMARK 1.5.1. In the notation of Definition 1.5, suppose that  $k$  is a *torally Kummer-faithful field*,  $l$  a prime number. Then it follows immediately from the injectivity of the Kummer map associated to  $\mathbb{G}_m$  over any finite extension of  $k$  that contains a primitive  $l$ -th root of unity that the *cyclotomic character*  $\chi_l : G_k \rightarrow \mathbb{Z}_l^\times$  has *open image* (cf. the notion of “ $l$ -cyclotomic fullness” discussed in [Mzk20], Lemma 4.5). In particular, it makes sense to speak of the “*power-equivalence class of  $\chi_l$* ” (cf. [Mzk20], Lemma 4.5, (ii)) among characters  $G_k \rightarrow \mathbb{Z}_l^\times$  — i.e., the equivalence class with respect to the equivalence relation  $\rho_1 \sim \rho_2$  (for characters  $\rho_1, \rho_2 : G_k \rightarrow \mathbb{Z}_l^\times$ ) defined by the condition that  $\rho_1^N = \rho_2^N$  for some positive integer  $N$ .

REMARK 1.5.2. By considering the *Weil restrictions* of semi-abelian varieties or tori over finite extensions of  $k$  to  $k$ , one verifies immediately that one obtains an equivalent definition of the terms “Kummer-faithful” and “torally Kummer-faithful” if, in Definition 1.5, one restricts  $k_H$  to be *equal to  $k$* .

REMARK 1.5.3. In the following discussion, if  $k$  is a *field*, then we denote the subgroup of *roots of unity* of  $k^\times$  by  $\mu(k) \subseteq k^\times$ .

(i) Let  $k$  be a(n) (not necessarily finite!) *algebraic* field extension of a *number field* such that there exists a *nonarchimedean prime* of  $k$  that is *unramified* over some number field contained in  $k$ , and, moreover, for every finite extension  $k^\dagger$  of  $k$ ,  $\mu(k^\dagger)$  is *finite*. Then I *claim* that:

$k$  is *torally Kummer-faithful*.

Indeed, since (as one verifies immediately) any finite extension of  $k$  satisfies the same hypotheses as  $k$ , one verifies immediately that it suffices to show that  $\bigcap_N (k^\times)^N = \{1\}$  (where  $N$  ranges over the positive integers). Let  $f \in \bigcap_N (k^\times)^N$ . If  $f \in \mu(k)$ , then the assumption concerning  $\mu(k)$  implies immediately that  $f = 1$ ; thus, we may assume without loss of generality that  $f \notin \mu(k)$ . But then there exists a nonarchimedean prime  $\mathfrak{p}$  of  $k$  that is *unramified* over some number field contained in  $k$ . In particular, if we write  $k_{\mathfrak{p}}$  for the completion of  $k$  at  $\mathfrak{p}$  and  $p$  for the residue characteristic of  $\mathfrak{p}$ , then  $k_{\mathfrak{p}}$  embeds into a finite extension of the quotient field of the ring of Witt vectors of an algebraic closure of  $\mathbb{F}_p$ . Thus, the fact that  $f$  admits arbitrary

$p$ -power roots in  $k_{\mathfrak{p}}$  yields a *contradiction*. This completes the proof of the *claim*.

(ii) It follows immediately from the definitions that “*Kummer-faithful*  $\implies$  *torally Kummer-faithful*”. On the other hand, as was pointed out to the author by *A. Tamagawa*, one may construct an example of a field which is *torally Kummer-faithful*, but *not Kummer-faithful*, as follows: Let  $E$  be an *elliptic curve* over a *number field*  $k_0$  that admits *complex multiplication* by  $\mathbb{Q}(\sqrt{-1})$  and, moreover, has *good reduction* at every nonarchimedean prime of  $k_0$ . Let  $\bar{k}$  be an algebraic closure of  $k_0$ ,  $G_{k_0} \stackrel{\text{def}}{=} \text{Gal}(\bar{k}/k_0)$ ,  $p$  a prime number  $\equiv 1 \pmod{4}$ . Write  $V$  for the  $p$ -adic Tate module associated to  $E$ . Thus, the  $G_{k_0}$ -module  $V$  decomposes (since  $p \equiv 1 \pmod{4}$ ) into a direct sum  $W \oplus W'$  of submodules  $W, W' \subseteq V$  of rank one. Write  $\chi : G_{k_0} \rightarrow \mathbb{Z}_p^\times$  for the character determined by  $W$ . Thus, (as is well-known)  $\chi$  is *unramified* over *every* nonarchimedean prime of  $k_0$  of residue characteristic  $l \neq p$ , as well as over *some* nonarchimedean prime of  $k_0$  of residue characteristic  $p$ . But one verifies immediately (for instance, by considering ramification over  $\mathbb{Q}$ ) that this implies that, if we write  $k$  for the extension field of  $k_0$  determined by the kernel of  $\chi$ , then  $\mu(k)$  is *finite*. Thus, since any finite extension of  $k_0$  satisfies the same hypotheses as  $k_0$ , we conclude that  $k$  *satisfies the hypotheses of (i)*, so  $k$  is *torally Kummer-faithful*. On the other hand, (by the definition of  $\chi, W, V!$ ) the Kummer map on  $E(k)$  is *not injective*, so  $k$  is *not Kummer-faithful*.

REMARK 1.5.4.

(i) Observe that every *sub- $p$ -adic field*  $k$  (cf. [Mzk5], Definition 15.4, (i)) is *Kummer-faithful*, i.e., “*sub- $p$ -adic*  $\implies$  *Kummer-faithful*”. Indeed, to verify this, one reduces immediately, by base-change, to the case where  $k$  is a *finitely generated extension* of an MLF, which may be thought of as the function field of a variety over an MLF. Then by restricting to various closed points of this variety, one reduces to the case where  $k$  itself is an MLF. On the other hand, if  $k$ , hence also  $k_H$  (cf. the notation of Definition 1.5), is a finite extension of  $\mathbb{Q}_p$ , then  $A(k_H)$  is an *extension of a finitely generated  $\mathbb{Z}$ -module by a compact abelian  $p$ -adic Lie group*, hence contains an open subgroup that is isomorphic to a finite product of copies of  $\mathbb{Z}_p$ . In particular, the condition of Definition 1.5, (a), is satisfied.

(ii) A similar argument to the argument of (i) shows that *every finitely*

generated extension of a Kummer-faithful field (respectively, torally Kummer-faithful field) is itself *Kummer-faithful* (respectively, *torally Kummer-faithful field*).

(iii) On the other hand, observe that if, for instance,  $I$  is an *infinite set*, then the field  $k \stackrel{\text{def}}{=} \mathbb{Q}_p(x_i)_{i \in I}$  (which is not a finitely generated extension of  $\mathbb{Q}_p$ ) constitutes an example of a *Kummer-faithful field* which is *not sub- $p$ -adic*. Indeed, if, for  $H$ ,  $A$  as in Definition 1.5,  $0 \neq f \in A(k_H)$  lies in the kernel of the associated Kummer map, then observe that there exists some *finite subset*  $I' \subseteq I$  such that if we set  $k' \stackrel{\text{def}}{=} \mathbb{Q}_p(x_i)_{i \in I'}$ , then, for some finite extension  $k'_H \subseteq k_H$  of  $k'$ , we may assume that  $A$  descends to a semi-abelian variety  $A'$  over  $k'_H$ , that  $f \in A'(k'_H) \subseteq A(k_H)$ , and that  $k_H = k'_H(x_i)_{i \in I''}$ , where we set  $I'' \stackrel{\text{def}}{=} I \setminus I'$ . Since  $k'_H$  is *algebraically closed* in  $k_H$ , it thus follows that all roots of  $f$  defined over  $k_H$  are in fact defined over  $k'_H$ . Thus, the existence of  $f$  contradicts the fact that the *sub- $p$ -adic field*  $k'_H$  is Kummer-faithful. Finally, to see that  $k$  is *not sub- $p$ -adic*, suppose that  $k \subseteq K$ , where  $K$  is a finitely generated extension of an MLF  $K_0$  of residue characteristic  $p_0$  such that  $K_0$  is *algebraically closed* in  $K$ . Let  $l \neq p, p_0$  be a prime number. Then

$$\mathbb{Q}_p \supseteq k^* \stackrel{\text{def}}{=} \bigcap_{l^N} (k^\times)^{l^N} \subseteq K^* \stackrel{\text{def}}{=} \bigcap_{l^N} (K^\times)^{l^N} \subseteq K_0$$

— where one verifies immediately that the additive group generated by  $k^*$  (respectively,  $K^*$ ) in  $k$  (respectively,  $K$ ) forms a compact open neighborhood of 0 in  $\mathbb{Q}_p$  (respectively,  $K_0$ ). In particular, it follows that the inclusion  $k \hookrightarrow K$  determines a *continuous homomorphism of topological fields*  $\mathbb{Q}_p \hookrightarrow K_0$ . But this implies immediately that  $p_0 = p$ , and that  $\mathbb{Q}_p \hookrightarrow K_0$  is a  *$\mathbb{Q}_p$ -algebra homomorphism*. Thus, the theory of *transcendence degree* yields a contradiction (for instance, by considering the morphism on Kähler differentials induced by  $k \hookrightarrow K$ ).

(iv) One verifies immediately that the *generalized sub- $p$ -adic fields* of [Mzk8], Definition 4.11, are *not*, in general, torally Kummer-faithful.

PROPOSITION 1.6 (Kummer Classes of Rational Functions). *In the situation of Proposition 1.4, suppose further that  $k$  is a Kummer-faithful field. If  $U \subseteq X$  is a nonempty open subscheme, then let us write*

$$\kappa_U : \Gamma(U, \mathcal{O}_U^\times) \rightarrow H^1(\Pi_U, M_X)$$

— where  $M_X \cong \widehat{\mathbb{Z}}(1)$  is as in Proposition 1.4, (ii) — for the associated Kummer map (cf., e.g., the discussion at the beginning of [Mzk19], §2). Also, for  $d \in \mathbb{Z}$ , let us write  $J^d \rightarrow \text{Spec}(k)$  for the connected component of the Picard scheme of  $X \rightarrow \text{Spec}(k)$  that parametrizes line bundles of degree  $d$  (cf., e.g., the discussion preceding [Mzk19], Proposition 2.2);  $J \stackrel{\text{def}}{=} J^0$ ;  $\Pi_{J^d} \stackrel{\text{def}}{=} \pi_1(J^d)$ . (Thus, we have a natural morphism  $X \rightarrow J^1$  that sends a point of  $X$  to the line bundle of degree 1 associated to the point; this morphism induces a surjection  $\Pi_X \twoheadrightarrow \Pi_{J^1}$  on étale fundamental groups whose kernel is equal to the commutator subgroup of  $\Delta_X$ .) Then:

(i) The Kummer map  $\kappa_U$  is injective.

(ii) For  $x \in X(k)$ , write  $s_x : G_k \rightarrow \Pi_X$  for the associated section (well-defined up to conjugation by  $\Delta_X$ ),  $t_x : G_k \rightarrow \Pi_{J^1}$  for the composite of  $s_x$  with the natural surjection  $\Pi_X \twoheadrightarrow \Pi_{J^1}$ . Then for any divisor  $D$  of degree  $d$  on  $X$  such that  $\text{Supp}(D) \subseteq X(k)$ , forming the appropriate  $\mathbb{Z}$ -linear combination of “ $t_x$ ’s” for  $x \in \text{Supp}(D)$  (cf., e.g., the discussion preceding [Mzk19], Proposition 2.2) yields a section  $t_D : G_k \rightarrow \Pi_{J^d}$ ; if, moreover,  $d = 0$ , then  $t_D : G_k \rightarrow \Pi_J$  coincides (up to conjugation by  $\Delta_X$ ) with the section determined by the identity element  $\in J(k)$  if and only if the divisor  $D$  is principal.

(iii) Suppose that  $U = X \setminus S$ , where  $S \subseteq X(k)$  is a finite subset. Then restricting cohomology classes of  $\Pi_U$  to the various  $I_x$  (cf. Proposition 1.4, (i)), for  $x \in S$ , yields a natural exact sequence

$$1 \rightarrow (k^\times)^\wedge \rightarrow H^1(\Pi_U, M_X) \rightarrow \left( \bigoplus_{x \in S} \widehat{\mathbb{Z}} \right)$$

— where we identify  $\text{Hom}_{\widehat{\mathbb{Z}}}(I_x, M_X)$  with  $\widehat{\mathbb{Z}}$  via the isomorphism  $I_x \xrightarrow{\sim} M_X$  of Proposition 1.4, (ii);  $(k^\times)^\wedge$  denotes the profinite completion of  $k^\times$ . Moreover, the image (via  $\kappa_U$ ) of  $\Gamma(U, \mathcal{O}_U^\times)$  in  $H^1(\Pi_U, M_X)/(k^\times)^\wedge$  is equal to the inverse image in  $H^1(\Pi_U, M_X)/(k^\times)^\wedge$  of the submodule of

$$\left( \bigoplus_{x \in S} \mathbb{Z} \right) \subseteq \left( \bigoplus_{x \in S} \widehat{\mathbb{Z}} \right)$$

determined by the principal divisors (with support in  $S$ ).

PROOF. Assertion (i) follows immediately (by restricting to smaller and smaller “ $U$ ’s”) from the fact (cf. Remark 1.5.4, (ii)) that since  $k$  is

(torally) *Kummer-faithful*, so is the function field  $K_X$  of  $X$ . Assertion (ii) follows from the argument of [Mzk19], Proposition 2.2, (i), together with the assumption that  $k$  is *Kummer-faithful*. As for assertion (iii), just as in the proof of [Mzk19], Proposition 2.1, (ii), to verify assertion (iii), it suffices to verify that  $H^0(G_k, \Delta_X^{\text{ab}}) = 0$ ; but, in light of the well-known relationship between  $\Delta_X^{\text{ab}}$  and the *torsion points* of the Jacobian  $J$ , the fact that  $H^0(G_k, \Delta_X^{\text{ab}}) = 0$  follows immediately from our assumption that  $k$  is *Kummer-faithful* (cf. the argument applied to  $\mathbb{G}_m$  in Remark 1.5.1).  $\square$

DEFINITION 1.7. Suppose that  $k$  is of *characteristic zero*. Let  $\bar{k}$  be an *algebraic closure* of  $k$ ; write  $\bar{k}_{\text{NF}} \subseteq \bar{k}$  for the (“*number field*”) *algebraic closure* of  $\mathbb{Q}$  in  $\bar{k}$ .

(i) We shall say that  $X$  is an *NF-curve* if  $X_{\bar{k}} \stackrel{\text{def}}{=} X \times_k \bar{k}$  is *defined* over  $\bar{k}_{\text{NF}}$  (cf. Remark 1.7.1 below).

(ii) Suppose that  $X$  is an *NF-curve*. Then we shall refer to points of  $X(\bar{k})$  (respectively, rational functions on  $X_{\bar{k}}$ ; constant rational functions on  $X_{\bar{k}}$  (i.e., which arise from elements of  $\bar{k}$ )) that descend to  $\bar{k}_{\text{NF}}$  (cf. Remark 1.7.1 below) as *NF-points* of (respectively, *NF-rational functions* on; *NF-constants* on)  $X_{\bar{k}}$ .

REMARK 1.7.1. Suppose that  $X$  is of *type*  $(g, r)$ . Then observe that  $X$  is an *NF-curve* if and only if the  $\bar{k}$ -valued point of the *moduli stack of hyperbolic curves of type*  $(g, r)$  over  $\mathbb{Q}$  determined by  $X$  arises, in fact, from a  $\bar{k}_{\text{NF}}$ -valued point. In particular, one verifies immediately that if  $X$  is an *NF-curve*, then the *descent data* of  $X_{\bar{k}}$  from  $\bar{k}$  to  $\bar{k}_{\text{NF}}$  is *unique*.

PROPOSITION 1.8 (Characterization of NF-Constants and NF-Rational Functions). *In the situation of Proposition 1.6, (iii), suppose further that  $U$  (hence also  $X$ ) is an NF-curve. Write*

$$\mathcal{P}_U \subseteq H^1(\Pi_U, M_X)$$

for the inverse image of the submodule of

$$\left( \bigoplus_{x \in S} \mathbb{Z} \right) \subseteq \left( \bigoplus_{x \in S} \widehat{\mathbb{Z}} \right)$$

determined by the cuspidal principal divisors (i.e., principal divisors supported on the cusps) — cf. Proposition 1.6, (iii). Then:

(i) A class  $\eta \in \mathcal{P}_U$  is the Kummer class of a nonconstant NF-rational function if and only if there exist a positive multiple  $\eta^\dagger$  of  $\eta$  and NF-points  $x_i \in U(k_x)$ , where  $i = 1, 2$ , and  $k_x$  is a finite extension of  $k$ , such that the cohomology classes

$$\eta^\dagger|_{x_i} \stackrel{\text{def}}{=} s_{x_i}^*(\eta^\dagger) \in H^1(G_{k_x}, M_X)$$

— where we write  $s_{x_i} : G_{k_x} \rightarrow \Pi_U$  for the (outer) homomorphism determined by  $x_i$  (cf. the notation of Proposition 1.6, (ii)) — satisfy  $\eta^\dagger|_{x_1} = 0$  (i.e.,  $= 1$ , if one works multiplicatively),  $\eta^\dagger|_{x_2} \neq 0$ .

(ii) Suppose that there exist nonconstant NF-rational functions  $\in \Gamma(U, \mathcal{O}_U^\times)$ . Then a class  $\eta \in \mathcal{P}_U \cap H^1(G_k, M_X) \cong (k^\times)^\wedge$  (cf. the exact sequence of Proposition 1.6, (iii)) is the Kummer class of an NF-constant  $\in k^\times$  if and only if there exist a nonconstant NF-rational function  $f \in \Gamma(U, \mathcal{O}_U^\times)$  and an NF-point  $x \in U(k_x)$ , where  $k_x$  is a finite extension of  $k$ , such that

$$\kappa_U(f)|_x = \eta|_{G_{k_x}} \in H^1(G_{k_x}, M_X)$$

— where we use the notation “ $\cdot|_x$ ” as in (i).

PROOF. Suppose that  $X_{\bar{k}}$  descends to a hyperbolic curve  $X_{\text{NF}}$  over  $\bar{k}_{\text{NF}}$ . Then (since  $\bar{k}_{\text{NF}}$  is algebraically closed) any nonconstant rational function on  $X_{\text{NF}}$  determines a morphism  $X_{\text{NF}} \rightarrow \mathbb{P}_{\bar{k}_{\text{NF}}}^1$  such that the induced map  $X_{\text{NF}}(\bar{k}_{\text{NF}}) \rightarrow \mathbb{P}_{\bar{k}_{\text{NF}}}^1(\bar{k}_{\text{NF}})$  is surjective. In light of this fact (cf. also the fact that  $U$  is also assumed to be an NF-curve), assertions (i), (ii) follow immediately from the definitions.  $\square$

Now, by combining the “reconstruction algorithms” given in the various results discussed above, we obtain the main result of the present §1.

**THEOREM 1.9** (The NF-portion of the Function Field via Belyi Cuspidalization over Sub- $p$ -adic Fields). *Let  $X$  be a hyperbolic orbicurve of strictly Belyi type (cf. [Mzk21], Definition 3.5) over a sub- $p$ -adic field (cf. [Mzk5], Definition 15.4, (i))  $k$ , for some prime  $p$ ;  $\bar{k}$  an algebraic closure of  $k$ ;  $\bar{k}_{\text{NF}} \subseteq \bar{k}$  the algebraic closure of  $\mathbb{Q}$  in  $\bar{k}$ ;*

$$1 \rightarrow \Delta_X \rightarrow \Pi_X \rightarrow G_k \rightarrow 1$$



— where  $\Pi_X \stackrel{\text{def}}{=} \pi_1(X) \rightarrow G_k \stackrel{\text{def}}{=} \text{Gal}(\bar{k}/k)$  denotes the natural surjection of étale fundamental groups (relative to some choice of basepoints), and  $\Delta_X$  denotes the kernel of this surjection — the resulting extension of profinite groups. Then there exists a functorial “group-theoretic” algorithm (cf. Remark 1.9.8 below for more on the meaning of this terminology) for reconstructing the “NF-portion of the function field” of  $X$  from the extension of profinite groups  $1 \rightarrow \Delta_X \rightarrow \Pi_X \rightarrow G_k \rightarrow 1$ ; this algorithm consists of the following steps:

(a) One constructs the various surjections

$$\Pi_U \twoheadrightarrow \Pi_Y$$

— where  $Y$  is a hyperbolic (NF-)curve that arises as a finite étale covering of  $X$ ;  $U \subseteq Y$  is an open subscheme obtained by removing an arbitrary finite collection of NF-points;  $\Pi_U \stackrel{\text{def}}{=} \pi_1(U)$ ;  $\Pi_Y \stackrel{\text{def}}{=} \pi_1(Y) \subseteq \Pi_X$  — via the technique of “Belyi cuspidalization”, as described in [Mzk21], Corollary 3.7, (a), (b), (c). Here, we note that by allowing  $U$  to vary, we obtain a “group-theoretic” construction of  $\Pi_U$  equipped with the collection of subgroups that arise as decomposition groups of NF-points.

(b) One constructs the natural isomorphisms

$$I_z \xrightarrow{\sim} \mu_{\mathbb{Z}}(\Pi_U) \stackrel{\text{def}}{=} M_Z$$

— where  $U \subseteq Y \rightarrow X$  is as in (i),  $Y$  is of genus  $\geq 2$ ,  $Z$  is the canonical compactification of  $Y$ , the points of  $Z \setminus U$  are all rational over the base field  $k_Z$  of  $Z$ ,  $z \in (Z \setminus U)(k_Z)$  — via the technique of Proposition 1.4, (ii).

(c) For  $U \subseteq Y \subseteq Z$  as in (b), one constructs the subgroup

$$\mathcal{P}_U \subseteq H^1(\Pi_U, \mu_{\mathbb{Z}}(\Pi_U))$$

determined by the cuspidal principal divisors via the isomorphisms of (b) and the characterization of principal divisors given in Proposition 1.6, (ii) (cf. also the decomposition groups of (a); Proposition 1.6, (iii)).

(d) For  $U \subseteq Y \subseteq Z$ ,  $k_Z$  as in (b), one constructs the subgroups

$$\bar{k}_{\text{NF}}^\times \subseteq K_{Z_{\text{NF}}}^\times \hookrightarrow \varinjlim_V H^1(\Pi_V, \mu_{\bar{z}}(\Pi_U))$$

— where  $V$  ranges over the open subschemes obtained by removing finite collections of NF-points from  $Z \times_{k_Z} k'$ , for  $k'$  a finite extension of  $k_Z$ ;  $\Pi_V \stackrel{\text{def}}{=} \pi_1(V)$ ;  $K_{Z_{\text{NF}}}$  is the function field of the curve  $Z_{\text{NF}}$  obtained by descending  $Z \times_{k_Z} \bar{k}$  to  $\bar{k}_{\text{NF}}$ ; the “ $\hookrightarrow$ ” arises from the Kummer map — via the subgroups of (c) and the characterizations of Kummer classes of nonconstant NF-rational functions and NF-constants given in Proposition 1.8, (i), (ii) (cf. also the decomposition groups of (a)).

(e) One constructs the additive structure on

$$\bar{k}_{\text{NF}}^\times \cup \{0\}; \quad K_{Z_{\text{NF}}}^\times \cup \{0\}$$

(notation as in (d)) by applying the functorial algorithm of Proposition 1.3 to the data of the form described in Proposition 1.3, (a), (b), (c), arising from the construction of (d) (cf. also the decomposition groups of (a), the isomorphisms of (b)).

Finally, the asserted “functoriality” is with respect to arbitrary open injective homomorphisms of extensions of profinite groups (cf. also Remark 1.10.1 below), as well as with respect to homomorphisms of extensions of profinite groups arising from a base-change of the base field (i.e.,  $k$ ).

PROOF. The validity of the algorithm asserted in Theorem 1.9 is immediate from the various results cited in the statement of this algorithm.  $\square$

REMARK 1.9.1. When  $k$  is an MLF (cf. [Mzk20], §0), one verifies immediately that one may give a *tempered version* of Theorem 1.9 (cf. [Mzk21], Remark 3.7.1), in which the profinite étale fundamental group  $\Pi_X$  is replaced by the *tempered fundamental group* of  $X$  (and the expression “profinite group” is replaced by “topological group”).

REMARK 1.9.2. When  $k$  is an MLF or NF (cf. [Mzk20], §0), the “extension of profinite groups  $1 \rightarrow \Delta_X \rightarrow \Pi_X \rightarrow G_k \rightarrow 1$ ” that appears in the

input data for the algorithm of Theorem 1.9 may be replaced by the single *profinite group*  $\Pi_X$  (cf. [Mzk20], Theorem 2.6, (v), (vi)). A similar remark applies in the *tempered* case discussed in Remark 1.9.1.

REMARK 1.9.3. Note that unlike the case with  $\bar{k}_{\text{NF}}, K_{Z_{\text{NF}}}$ , the algorithm of Theorem 1.9 does *not* furnish a means for reconstructing  $\bar{k}, K_Z$  in general — cf. Corollary 1.10 below concerning the case when  $k$  is an *MLF*.

REMARK 1.9.4. Suppose that  $k$  is an *MLF*. Then  $G_k$ , which is of *cohomological dimension 2* (cf. [NSW], Theorem 7.1.8, (i)), may be thought of as having *one rigid dimension* and *one non-rigid dimension*. Indeed, the *maximal unramified quotient*

$$G_k \twoheadrightarrow G_k^{\text{unr}} \cong \widehat{\mathbb{Z}}$$

is generated by the *Frobenius element*, which may be characterized by an entirely *group-theoretic algorithm* (hence is preserved by isomorphisms of absolute Galois groups of *MLF*'s — cf. [Mzk9], Proposition 1.2.1, (iv)); thus, this quotient  $G_k \twoheadrightarrow G_k^{\text{unr}} \cong \widehat{\mathbb{Z}}$  may be thought of as a *“rigid dimension”*. On the other hand, the dimension of  $G_k$  represented by the *inertia group* in

$$I_k \subseteq G_k$$

(which, as is well-known, is of cohomological dimension 1) is *“far from rigid”* — a phenomenon that may be seen, for instance, in the existence (cf., e.g., [NSW], the Closing Remark preceding Theorem 12.2.7) of isomorphisms of absolute Galois groups of *MLF*'s which *fail* (equivalently — cf. [Mzk20], Corollary 3.7) to be *“RF-preserving”*, *“uniformly toral”*, or *“geometric”*. By contrast, it is interesting to observe that:

The “group-theoretic” algorithm of Theorem 1.9 shows that the condition of being *“coupled with  $\Delta_X$ ”* (i.e., via the extension determined by  $\Pi_X$ ) has the effect of *rigidifying both of the 2 dimensions of  $G_k$*  (cf. also Corollary 1.10 below).

This point of view will be of use in our development of the *archimedean theory* in §2 below (cf., e.g., Remark 2.7.3 below).

## REMARK 1.9.5.

(i) Note that the *functoriality with respect to isomorphisms* of the algorithm of Theorem 1.9 may be regarded as yielding a *new proof* of the “*profinite absolute version of the Grothendieck Conjecture over number fields*” (cf., e.g., [Mzk15], Theorem 3.4) that does *not logically depend on the theorem of Neukirch-Uchida* (cf., e.g., [Mzk15], Theorem 3.1). Moreover, to the author’s knowledge:

The technique of Theorem 1.9 yields the first logically independent proof of a consequence of the theorem of Neukirch-Uchida that involves an *explicit construction of the number fields* involved.

Put another way, the algorithm of Theorem 1.9 yields a proof of a consequence of the theorem of Neukirch-Uchida on *number fields* in the style of Uchida’s work on *function fields in positive characteristic* (i.e., [Uchi]) — cf., especially, Proposition 1.3.

(ii) One aspect of the theorem of Neukirch-Uchida is that its proof relies essentially on the data arising from the *decomposition of primes* in finite extensions of a number field — i.e., in other words, on the “*global address*” of a prime among all the primes of a number field. Such a “global address” is manifestly *annihilated* by the operation of *localization at the prime* under consideration. In particular, the *crucial functoriality* of Theorem 1.9 with respect to *change of base field* (e.g., from a number field to a nonarchimedean completion of the number field) is another reflection of the way in which the nature of the proof of Theorem 1.9 over number fields differs quite fundamentally from the *essentially global* proof of the theorem of Neukirch-Uchida (cf. also Remark 3.7.6, (iii), (v), below). This “crucial functoriality” may also be thought of as a sort of *essential independence* of the algorithms of Theorem 1.9 from *both* methods which are essentially *global* in nature (such as methods involving the “global address” of a prime) *and* methods which are essentially *local* in nature (such as methods involving  $p$ -adic Hodge theory — cf. Remark 3.7.6, (iii), (v), below). This point of view concerning the “essential independence of the base field” is developed further in Remark 1.9.7 below.

REMARK 1.9.6. By combining the theory of the present §1 with the theory of [Mzk21], §1 (cf., e.g., [Mzk21], Corollary 1.11 and its proof), one

may obtain “*functorial group-theoretic reconstruction algorithms*”, in a number of cases, for finite étale coverings of *configuration spaces* associated to hyperbolic curves. We leave the routine details to the interested reader.

REMARK 1.9.7. One way to think of the construction algorithm in Theorem 1.9 of the “NF-portion of the function field” of a hyperbolic orbicurve of strictly Belyi type over a sub- $p$ -adic field is the following:

The *algorithm* of Theorem 1.9 may be thought of as a sort of *complete “combinatorialization”* — independent of the base field! — of the (*algebraic-geometric* object constituted by the) orbicurve under consideration.

This sort of “*combinatorialization*” may be thought of as being in a similar vein — albeit much more technically complicated! — to the “*combinatorialization*” of a category of finite étale coverings of a connected scheme via the notion of an *abstract Galois category*, or the “*combinatorialization*” of certain aspects of the commutative algebra of “normal rings with toral singularities” via the *abstract monoids* that appear in the theory of log regular schemes (cf. also the Introduction of [Mzk16] for more on this point of view).

REMARK 1.9.8. Typically in discussions of anabelian geometry, the term “*group-theoretic*” is applied to a property or construction that is *preserved* by the *isomorphisms* (or homomorphisms) of *fundamental groups* under consideration (cf., e.g., [Mzk5]). By contrast, our use of this term is intended in a *stronger sense*. That is to say:

We use the term “*group-theoretic algorithm*” to mean that the algorithm in question is phrased in *language* that only depends on the *topological group structure* of the fundamental group under consideration.

(Thus, the more “classical” use (e.g., in [Mzk5]) of the term “group-theoretic” corresponds, in our discussion of “group-theoretic algorithms”, to the *functoriality* — e.g., with respect to isomorphisms of some type — of the algorithm.) In particular, one fundamental difference between the approach usually taken to anabelian geometry and the approach taken in the present paper is the following:

The “classical” approach to anabelian geometry, which we shall refer to as *bi-anabelian*, centers around a *comparison between two geometric objects* (e.g., hyperbolic orbicurves) via their (arithmetic) fundamental groups. By contrast, the theory of the present paper, which we shall refer to as *mono-anabelian*, centers around the task of establishing “*group-theoretic algorithms*” — i.e., “*group-theoretic software*” — that require as input data only the (arithmetic) fundamental group of a *single geometric object*.

Thus, it follows formally that

$$\text{“mono-anabelian”} \implies \text{“bi-anabelian”}.$$

On the other hand, if one is allowed in one’s algorithms to introduce some *fixed reference model* of the geometric object under consideration, then the task of establishing an “algorithm” may, in effect, be *reduced to “comparison with the fixed reference model”*, i.e., reduced to some sort of result in “bi-anabelian geometry”. That is to say, if one is unable to settle the issue of *ruling out* the use of such models, then there remains the possibility that

$$\text{“bi-anabelian”} \stackrel{?}{\implies} \text{“mono-anabelian”}.$$

We shall return to this *crucial issue* in §3 below (cf., especially, Remark 3.7.3).

REMARK 1.9.9. As was pointed out to the author by *M. Kim*, one may also think of the algorithms of a result such as Theorem 1.9 as suggesting an approach to solving the problem of *characterizing “group-theoretically” those profinite groups  $\Pi$  that occur* (i.e., in Theorem 1.9) *as a “ $\Pi_X$ ”*. That is to say, one may try to obtain such a characterization by starting with, say, an arbitrary slim profinite group  $\Pi$  and then proceeding to impose “*group-theoretic*” conditions on  $\Pi$  corresponding to the various steps of the algorithms of Theorems 1.9 — i.e., conditions whose content consists of minimal assumptions on  $\Pi$  that are necessary in order to execute each step of the algorithm.

COROLLARY 1.10 (Reconstruction of the Function Field for MLF’s). *Let  $X$  be a hyperbolic orbicurve over an MLF  $k$  (cf. [Mzk20], §0);  $\bar{k}$  an*

algebraic closure of  $k$ ;  $\bar{k}_{\text{NF}} \subseteq \bar{k}$  the algebraic closure of  $\mathbb{Q}$  in  $\bar{k}$ ;

$$1 \rightarrow \Delta_X \rightarrow \Pi_X \rightarrow G_k \rightarrow 1$$

— where  $\Pi_X \stackrel{\text{def}}{=} \pi_1(X) \rightarrow G_k \stackrel{\text{def}}{=} \text{Gal}(\bar{k}/k)$  denotes the natural surjection of étale fundamental groups (relative to some choice of basepoints), and  $\Delta_X$  denotes the kernel of this surjection — the resulting extension of profinite groups. Then:

(i) There exists a functorial “group-theoretic” algorithm for reconstructing the natural isomorphism  $H^2(G_k, \mu_{\widehat{\mathbb{Z}}}(G_k)) \xrightarrow{\sim} \widehat{\mathbb{Z}}$  (cf. (a) below), together with the natural surjection  $H^1(G_k, \mu_{\widehat{\mathbb{Z}}}(G_k)) \xrightarrow{\sim} G_k^{\text{ab}} \twoheadrightarrow \widehat{\mathbb{Z}}$  (cf. (b) below) from the profinite group  $G_k$ , as follows:

(a) Write:

$$\mu_{\mathbb{Q}/\mathbb{Z}}(G_k) \stackrel{\text{def}}{=} \varinjlim_H (H^{\text{ab}})_{\text{tors}}; \quad \mu_{\widehat{\mathbb{Z}}}(G_k) \stackrel{\text{def}}{=} \text{Hom}(\mathbb{Q}/\mathbb{Z}, \mu_{\mathbb{Q}/\mathbb{Z}}(G_k))$$

— where  $H$  ranges over the open subgroups of  $G_k$ ; the notation “ $(-)$ <sub>tors</sub>” denotes the torsion subgroup of the abelian group in parentheses; the arrows of the direct limit are induced by the *Verlagerung*, or transfer, map (cf. the discussion preceding [Mzk9], Proposition 1.2.1; the proof of [Mzk9], Proposition 1.2.1). (Thus, the underlying module of  $\mu_{\mathbb{Q}/\mathbb{Z}}(G_k)$ ,  $\mu_{\widehat{\mathbb{Z}}}(G_k)$  is unaffected by the operation of passing from  $G_k$  to an open subgroup of  $G_k$ .) Then one constructs the natural isomorphism

$$H^2(G_k, \mu_{\widehat{\mathbb{Z}}}(G_k)) \xrightarrow{\sim} \widehat{\mathbb{Z}}$$

“group-theoretically” from  $G_k$  via the algorithm described in the proof of [Mzk9], Proposition 1.2.1, (vii).

(b) By applying the isomorphism of (a) (and the cup-product in group cohomology), one constructs the surjection

$$H^1(G_k, \mu_{\widehat{\mathbb{Z}}}(G_k)) \xrightarrow{\sim} G_k^{\text{ab}} \twoheadrightarrow G^{\text{unr}} \xrightarrow{\sim} \widehat{\mathbb{Z}}$$

determined by the Frobenius element in the maximal unramified quotient  $G^{\text{unr}}$  of  $G_k$  via the “group-theoretic” algorithm described in the proof of [Mzk9], Proposition 1.2.1, (ii), (iv).

Here, the asserted “functoriality” is with respect to arbitrary injective open homomorphisms of profinite groups (cf. also Remark 1.10.1, (iii), below).

(ii) By applying the functorial “group-theoretic” algorithm of [Mzk20], Lemma 4.5, (v), to construct the decomposition groups of cusps in  $\Pi_X$ , one obtains a  $\Pi_X$ -module  $\mu_{\widehat{\mathbb{Z}}}(\Pi_X)$  as in Proposition 1.4, (ii); Theorem 1.9, (b) (cf. also Remark 1.10.1, (ii), below). Then there exists a functorial “group-theoretic” algorithm for reconstructing the natural isomorphism  $\mu_{\widehat{\mathbb{Z}}}(G_k) \xrightarrow{\sim} \mu_{\widehat{\mathbb{Z}}}(\Pi_X)$  (cf. (c) below; Remark 1.10.1 below) and the image of a certain Kummer map (cf. (d) below) from the profinite group  $\Pi_X$  (cf. Remark 1.9.2), as follows:

- (c) One constructs the natural isomorphism (cf., e.g., [Mzk12], Theorem 4.3)

$$\mu_{\widehat{\mathbb{Z}}}(G_k) \xrightarrow{\sim} \mu_{\widehat{\mathbb{Z}}}(\Pi_X)$$

— thought of as an element of the quotient

$$H^1(G_k, \mu_{\widehat{\mathbb{Z}}}(\Pi_X)) \rightarrow \text{Hom}(\mu_{\widehat{\mathbb{Z}}}(G_k), \mu_{\widehat{\mathbb{Z}}}(\Pi_X))$$

determined by the surjection of (b) — as the unique topological generator of  $\text{Hom}(\mu_{\widehat{\mathbb{Z}}}(G_k), \mu_{\widehat{\mathbb{Z}}}(\Pi_X))$  that is contained in the “positive rational structure” (arising from various  $J^{\text{ab}}$ , for  $J \subseteq \Delta_X$  an open subgroup) of [Mzk9], Lemma 2.5, (i) (cf. also [Mzk9], Lemma 2.5, (ii)).

- (d) One constructs the image of the Kummer map

$$k^\times \hookrightarrow H^1(G_k, \mu_{\widehat{\mathbb{Z}}}(\Pi_X)) \hookrightarrow H^1(\Pi_X, \mu_{\widehat{\mathbb{Z}}}(\Pi_X))$$

as the inverse image of the subgroup generated by the Frobenius element via the surjection  $H^1(G_k, \mu_{\widehat{\mathbb{Z}}}(\Pi_X)) \xrightarrow{\sim} H^1(G_k, \mu_{\widehat{\mathbb{Z}}}(G_k)) \xrightarrow{\sim} G_k^{\text{ab}} \rightarrow \widehat{\mathbb{Z}}$  of (b) (cf. also the isomorphism of (c)).

- (d') Alternatively, if  $X$  is of strictly Belyi type (so that we are in the situation of Theorem 1.9), then one may construct the image of the Kummer map of (d) — without applying the isomorphism of (c) — as the completion of  $H^1(G_k, \mu_{\widehat{\mathbb{Z}}}(\Pi_X)) \cap \overline{k}_{\text{NF}}^\times$  (cf. Theorem 1.9, (e)) with respect to the valuation on the field  $(H^1(G_k, \mu_{\widehat{\mathbb{Z}}}(\Pi_X)) \cap \overline{k}_{\text{NF}}^\times) \cup \{0\}$  (relative to the additive structure



of Theorem 1.9, (e)) determined by the subring of this field generated by the intersection  $\text{Ker}(H^1(G_k, \mu_{\widehat{\mathbb{Z}}}(\Pi_X)) \twoheadrightarrow \widehat{\mathbb{Z}}) \cap \overline{k}_{\text{NF}}^\times$  — where “ $\twoheadrightarrow$ ” is the surjection of (b), considered up to multiplication by  $\widehat{\mathbb{Z}}^\times$ , an object which is independent of the isomorphism of (c).

Here, the asserted “functoriality” is with respect to arbitrary open injective homomorphisms of extensions of profinite groups — cf. Remark 1.10.1 below.

(iii) Suppose further that  $X$  is of strictly Belyi type (so that we are in the situation of Theorem 1.9). Then there exists a functorial “group-theoretic” algorithm for reconstructing the function field  $K_X$  of  $X$  from the profinite group  $\Pi_X$  (cf. Remark 1.9.2), as follows:

- (e) One constructs the decomposition groups in  $\Pi_X$  of arbitrary closed points of  $X$  by approximating such points by NF-points of  $X$  (whose decomposition groups have already been constructed, in Theorem 1.9, (a)), via the equivalence of [Mzk12], Lemma 3.1, (i), (iv).
- (f) For  $S$  a finite set of closed points of  $X$ , one constructs the associated “maximal abelian cuspidalization”

$$\Pi_{U_S}^{\text{c-ab}}$$

of  $U_S \stackrel{\text{def}}{=} X \setminus S$  via the algorithm of [Mzk19], Theorem 2.1, (i) (cf. also [Mzk19], Theorem 1.1, (iii), as well as Remark 1.10.4, below). Moreover, by applying the approximation technique of (e) to the Belyi cuspidalizations of Theorem 1.9, (a), one may construct the Green’s trivializations (cf. [Mzk19], Definition 2.1; [Mzk19], Remark 15) for arbitrary pairs of closed points of  $X$  such that one point of the pair is an NF-point; in particular, one may construct the liftings to  $\Pi_{U_S}^{\text{c-ab}}$  (from  $\Pi_X$ ) of decomposition groups of NF-points.

- (g) By applying the “maximal abelian cuspidalizations”  $\Pi_{U_S}^{\text{c-ab}}$  of (f), together with the characterization of principal divisors given in Proposition 1.6, (ii) (cf. also the decomposition groups of

(e)), one constructs the subgroup

$$\mathcal{P}_{U_S} \subseteq H^1(\Pi_{U_S}^{\text{c-ab}}, \mu_{\mathbb{Z}}(\Pi_X)) (\cong H^1(\Pi_{U_S}, \mu_{\mathbb{Z}}(\Pi_X)))$$

(cf. [Mzk19], Proposition 2.1, (i), (ii)) determined by the cuspidal principal divisors via the isomorphisms of Theorem 1.9, (b). Then the image of the Kummer map in  $\mathcal{P}_{U_S}$  may be constructed as the collection of elements of  $\mathcal{P}_{U_S}$  whose restriction  $\in H^1(G_{k'}, \mu_{\mathbb{Z}}(\Pi_X))$  — where  $G_{k'} \subseteq G_k$  is an open subgroup corresponding to a finite extension  $k' \subseteq \bar{k}$  of  $k$  — to a decomposition group of some NF-point (cf. (f)) is contained in  $(k')^\times \subseteq ((k')^\times)^\wedge \xrightarrow{\sim} H^1(G_{k'}, \mu_{\mathbb{Z}}(\Pi_X))$  (cf. (d) or, alternatively, (d')).

(h) One constructs the additive structure on (the image — cf. (d) — of)  $k^\times \cup \{0\}$  as the unique continuous extension of the additive structure on  $(k^\times \cap \bar{k}_{\text{NF}}^\times) \cup \{0\}$  constructed in Theorem 1.9, (e). One constructs the image of the Kummer map

$$K_X^\times \hookrightarrow \varinjlim_S H^1(\Pi_{U_S}^{\text{c-ab}}, \mu_{\mathbb{Z}}(\Pi_X))$$

by letting  $S$  as in (g) vary. One constructs the additive structure on  $K_X^\times \cup \{0\}$  as the unique additive structure compatible, relative to the operation of restriction to decomposition groups of NF-points (cf. (f)), with the additive structures on the various  $(k')^\times \cup \{0\}$ , for  $k' \subseteq \bar{k}$  a finite extension of  $k$ . Also, one may construct the restrictions of elements of  $K_X^\times$  to decomposition groups not only of NF-points, but also of arbitrary closed points of  $X$ , by approximating as in (e); this allows one (by letting  $k$  vary among finite extensions of  $k$  in  $\bar{k}$ ) to give an alternative construction of the additive structure on  $K_X^\times \cup \{0\}$  by applying Proposition 1.3 directly (i.e., over  $\bar{k}$ , as opposed to  $\bar{k}_{\text{NF}}$ ).

Here, the asserted “functoriality” is with respect to arbitrary open injective homomorphisms of profinite groups (i.e., of “ $\Pi_X$ ”) — cf. Remark 1.10.1 below.

PROOF. The validity of the algorithms asserted in Corollary 1.10 is immediate from the various results cited in the statement of these algorithms.  $\square$

REMARK 1.10.1.

(i) In general, the *functoriality* of Theorem 1.9, Corollary 1.10, when applied to the operation of passing to *open subgroups* of  $\Pi_X$ , is to be understood in the sense of a “*compatibility*”, relative to *dividing* the usual functorially induced morphism on “ $\mu_{\widehat{\mathbb{Z}}}(\Pi_X)$ ’s” by a *factor* given by the *index* of the subgroups of  $\Delta_X$  that arise from the open subgroups of  $\Pi_X$  under consideration (cf., e.g., [Mzk19], Remark 1).

(ii) In fact, strictly speaking, the definition of “ $\mu_{\widehat{\mathbb{Z}}}(\Pi_U)$ ” in Theorem 1.9, (b), is only valid if  $U$  is a hyperbolic curve of genus  $\geq 2$ ; nevertheless, one may *extend* this definition to the case where  $U$  is an arbitrary hyperbolic orbicurve precisely by passing to coverings and applying the “*functoriality/compatibility*” discussed in (i). We leave the routine details to the reader.

(iii) In a similar vein, note that the isomorphism  $H^2(G_k, \mu_{\widehat{\mathbb{Z}}}(G_k)) \xrightarrow{\sim} \widehat{\mathbb{Z}}$  of Corollary 1.10, (a), is *functorial* in the sense that it is *compatible* with the result of *dividing* the usual functorially induced morphism by a *factor* given by the *index* of the open subgroups of  $G_k$  under consideration.

REMARK 1.10.2. Just as was the case with Theorem 1.9, one may give a *tempered* version of Corollary 1.10 — cf. Remark 1.9.1.

REMARK 1.10.3.

(i) The isomorphism of Corollary 1.10, (c), may be thought of as a sort of “*synchronization of (arithmetic and geometric) cyclotomes*”, in the style of the “*synchronization of cyclotomes*” given in the final display of Proposition 1.4, (ii).

(ii) One may construct the *natural isomorphism*

$$G_k^{\text{ab}} \xrightarrow{\sim} H^1(G_k, \mu_{\widehat{\mathbb{Z}}}(\Pi_X))$$

by applying the displayed isomorphism of Corollary 1.10, (c), to the inverse of the first displayed isomorphism of Corollary 1.10, (b). By applying this natural isomorphism to various open subgroups of  $G_k$ , we thus obtain yet another *isomorphism of cyclotomes*

$$\mu_{\widehat{\mathbb{Z}}}(G_k) \xrightarrow{\sim} \mu_{\widehat{\mathbb{Z}}}^{\kappa}(\Pi_X) \stackrel{\text{def}}{=} \text{Hom}(\mathbb{Q}/\mathbb{Z}, \kappa(\overline{k}_{\text{NF}}^{\times}))$$

— where we write  $\kappa(\bar{k}_{\text{NF}}^\times)$  for the image of  $\bar{k}_{\text{NF}}^\times$  in

$$\varinjlim_V H^1(\Pi_V, \mu_{\mathbb{Z}}(\Pi_U))$$

via the inclusion induced by the *Kummer map* in the display of Theorem 1.9, (d).

REMARK 1.10.4. Here, we take the opportunity to correct an unfortunate misprint in the proof of [Mzk19], Theorem 1.1, (iii). The phrase “ $Z'_X \rightarrow X, Z'_Y \rightarrow Y$  are *diagonal coverings*” that appears at the beginning of this proof should read “ $Z'_X \rightarrow X \times X, Z'_Y \rightarrow Y \times Y$  are *diagonal coverings*”.

Finally, we conclude the present §1 by observing that the techniques developed in the present §1 may be interpreted as implying a *very elementary semi-absolute birational analogue* of Theorem 1.9.

THEOREM 1.11 (Semi-absolute Reconstruction of Function Fields of Curves over Kummer-faithful Fields). *Let  $X$  be a smooth, proper, geometrically connected curve of genus  $g_X$  over a Kummer-faithful field  $k$ ;  $K_X$  the function field of  $X$ ;  $\eta_X \stackrel{\text{def}}{=} \text{Spec}(K_X)$ ;  $\bar{k}$  an algebraic closure of  $k$ ;*

$$1 \rightarrow \Delta_{\eta_X} \rightarrow \Pi_{\eta_X} \rightarrow G_k \rightarrow 1$$

— where  $\Pi_{\eta_X} \stackrel{\text{def}}{=} \pi_1(\eta_X) \rightarrow G_k \stackrel{\text{def}}{=} \text{Gal}(\bar{k}/k)$  denotes the natural surjection of étale fundamental groups (relative to some choice of basepoints), and  $\Delta_{\eta_X}$  denotes the kernel of this surjection — the resulting extension of profinite groups. Then  $\Delta_{\eta_X}, \Pi_{\eta_X}$ , and  $G_k$  are slim. For simplicity, let us suppose further (for instance, by replacing  $X$  by a finite étale covering of  $X$ ) that  $g_X \geq 2$ . Then there exists a functorial “group-theoretic” algorithm for reconstructing the function field  $K_X$  from the extension of profinite groups  $1 \rightarrow \Delta_{\eta_X} \rightarrow \Pi_{\eta_X} \rightarrow G_k \rightarrow 1$ ; this algorithm consists of the following steps:

- (a) Let  $l$  be a prime number. If  $\rho : G_k \rightarrow \mathbb{Z}_l^\times$  is a character, and  $M$  is an abelian pro- $l$  group equipped with a continuous action by  $G_k$ , then let us write  $\mathcal{F}_\rho(M) \subseteq M$  for the closed subgroup topologically generated by the closed subgroups of  $M$  that are isomorphic to  $\mathbb{Z}_l(\rho)$  (i.e., the  $G_k$ -module obtained by letting  $G_k$  act

on  $\mathbb{Z}_l$  via  $\rho$ ) as  $H$ -modules, for some open subgroup  $H \subseteq G_k$ . (Thus,  $\mathcal{F}_\rho(M) \subseteq M$  depends only on the “power-equivalence class” of  $\rho$  — cf. Remark 1.5.1.) Then the power-equivalence class of the cyclotomic character  $\chi_l : G_k \rightarrow \mathbb{Z}_l^\times$  may be characterized by the condition that  $\mathcal{F}_{\chi_l}(\Delta_{\eta_X}^{\text{ab}} \otimes \mathbb{Z}_l)$  is not topologically finitely generated.

- (b) Let  $l$  be a prime number. If  $M$  is an abelian pro- $l$  group equipped with a continuous action by  $G_k$  such that  $M/\mathcal{F}_{\chi_l}(M)$  is topologically finitely generated, then let us write  $M \twoheadrightarrow \mathcal{T}(M)$  for the maximal torsion-free quasi-trivial quotient (i.e., maximal torsion-free quotient on which  $G_k$  acts through a finite quotient). (Thus, one verifies immediately that “ $\mathcal{T}(M)$ ” is well-defined.) Then one may compute the genus of  $X$  via the formula (cf. the proof of [Mzk21], Corollary 2.10)

$$2g_X = \dim_{\mathbb{Q}_l}(\mathcal{Q}(\Delta_{\eta_X}^{\text{ab}} \otimes \mathbb{Z}_l) \otimes \mathbb{Q}_l) + \dim_{\mathbb{Q}_l}(\mathcal{T}(\Delta_{\eta_X}^{\text{ab}} \otimes \mathbb{Z}_l) \otimes \mathbb{Q}_l)$$

— where we write  $\mathcal{Q}(-) \stackrel{\text{def}}{=} (-)/\mathcal{F}_{\chi_l}(-)$ . In particular, this allows one to characterize, via the Hurwitz formula, those pairs of open subgroups  $J_i \subseteq H_i \subseteq \Delta_{\eta_X}$  such that “the covering between  $J_i$  and  $H_i$  is cyclic of order a power of  $l$  and totally ramified at precisely one closed point but unramified elsewhere” (cf. the proof of [Mzk21], Corollary 2.10). Moreover, this last characterization implies a “group-theoretic” characterization of the inertia subgroups  $I_x \subseteq \Delta_{\eta_X}$  of points  $x \in X(\bar{k})$  (cf. the proof of [Mzk21], Corollary 2.10; the latter portion of the proof of [Mzk9], Lemma 1.3.9), hence of the quotient  $\Delta_{\eta_X} \twoheadrightarrow \Delta_X$  (whose kernel is topologically normally generated by the  $I_x$ , for  $x \in X(\bar{k})$ ). Finally, the decomposition group  $D_x \subseteq \Pi_{\eta_X}$  of  $x \in X(\bar{k})$  may then be constructed as the normalizer (or, equivalently, commensurator) of  $I_x$  in  $\Pi_{\eta_X}$  (cf., e.g., [Mzk12], Theorem 1.3, (ii)).

- (c) One may construct the natural isomorphisms  $I_x \xrightarrow{\sim} M_X$  (where  $x \in X(\bar{k})$ ;  $M_X$  is as in Proposition 1.4, (ii)) via the technique of Proposition 1.4, (ii). These isomorphisms determine (by re-

striction to the  $I_x$ ) a natural map

$$H^1(\Pi_{\eta_X}, M_X) \rightarrow \prod_{x \in X(\bar{k})} \widehat{\mathbb{Z}}$$

(cf. Proposition 1.6, (iii)). Denote by  $\mathcal{P}_{\eta_X} \subseteq H^1(\Pi_{\eta_X}, M_X)$  (cf. Proposition 1.8) the inverse image in  $H^1(\Pi_{\eta_X}, M_X)$  of the subgroup of

$$\prod_{x \in X(\bar{k})} \widehat{\mathbb{Z}}$$

consisting of the principal divisors — i.e., divisors  $D$  of degree zero supported on a collection of points  $\in X(k_H)$ , where  $k_H \subseteq \bar{k}$  is the subfield corresponding to an open subgroup  $H \subseteq G_k$ , whose associated class  $\in H^1(H, \Delta_X^{\text{ab}})$  (i.e., the class obtained as the difference between the section “ $t_D$ ” of Proposition 1.6, (ii), and the identity section) is trivial.

(d) The image of the Kummer map

$$K_X^\times \rightarrow H^1(\Pi_{\eta_X}, M_X)$$

may be constructed as the subgroup generated by elements  $\theta \in \mathcal{P}_{\eta_X}$  for which there exists an  $x \in X(\bar{k})$  such that  $\theta|_x \in H^1(D_x, M_X)$  vanishes (i.e.,  $= 1$ , if one works multiplicatively) — cf. the technique of Proposition 1.8, (i). Moreover, the additive structure on  $K_X^\times \cup \{0\}$  may be recovered via the algorithm of Proposition 1.3.

Finally, the asserted “functoriality” is with respect to arbitrary open injective homomorphisms of extensions of profinite groups (cf. Remark 1.10.1, (i)).

PROOF. The *slimness* of  $\Delta_{\eta_X}$  follows immediately from the argument applied to verify the slimness portion of [Mzk21], Corollary 2.10. The validity of the reconstruction algorithm asserted in Theorem 1.11 is immediate from the various results cited in the statement of this algorithm. Now, by applying the *functoriality* of this algorithm, the *slimness* of  $G_k$  follows immediately from the argument applied in [Mzk5], Lemma 15.8, to verify the

slimness of  $G_k$  when  $k$  is *sub- $p$ -adic*. Finally, the slimness of  $\Pi_{\eta_X}$  follows from the slimness of  $\Delta_{\eta_X}, G_k$ .  $\square$

REMARK 1.11.1.

(i) One verifies immediately that when  $k$  is an *MLF*, the *semi-absolute* algorithms of Theorem 1.11 may be rendered *absolute* (i.e., one may construct the kernel of the quotient “ $\Pi_{\eta_X} \twoheadrightarrow G_k$ ”) by applying the *algorithm* that is implicit in the proof of the corresponding portion of [Mzk21], Corollary 2.10.

(ii) Suppose, in the notation of Theorem 1.11 that  $k$  is an *NF*. Then an *absolute version* of the functoriality portion (i.e., the “Grothendieck Conjecture” portion) of Theorem 1.11 is proven in [Pop] (cf. [Pop], Theorem 2). Moreover, in [Pop], Observation (and the following discussion), an *algorithm* is given for passing from the *absolute* data “ $\Pi_{\eta_X}$ ” to the *semi-absolute* data “ $(\Pi_{\eta_X}, \Delta_{\eta_X} \subseteq \Pi_{\eta_X})$ ”. Thus, by combining this algorithm of [Pop] with Theorem 1.11, one obtains an *absolute* version of Theorem 1.11.

REMARK 1.11.2. One may think of the argument used to prove the *slimness* of  $G_k$  in the proof of Theorem 1.11 (i.e., the argument of the proof of [Mzk5], Lemma 15.8) as being *similar in spirit* to the proof (cf., e.g., [Mzk9], Theorem 1.1.1, (ii)) of the slimness of  $G_k$  via *local class field theory* in the case where  $k$  is an *MLF*, as well as to the proof of the slimness of the geometric fundamental group of a hyperbolic curve given, for instance, in [MT], Proposition 1.4, via the induced action on the torsion points of the *Jacobian* of the curve, in which the curve may be embedded. That is to say, in the case where  $k$  is an *arbitrary Kummer-faithful field*, since one does not have an analogue of local class field theory (respectively, of the embedding of a curve in its Jacobian), the *moduli* of hyperbolic curves over  $k$ , in the context of a *relative anabelian result for the arithmetic fundamental groups of such curves*, plays the role of the *abelianization* of  $G_k$  (respectively, of the torsion points of the *Jacobian*) in the case where  $k$  is an *MLF* (respectively, in the case of the geometric fundamental group of a hyperbolic curve) — i.e., the role of a “*functorial, group-theoretically reconstructible embedding*” of  $k$  (respectively, the curve).

REMARK 1.11.3. It is interesting to note that the techniques that appear in the algorithms of Theorem 1.11 are *extremely elementary*. For in-

stance, unlike the case with Theorem 1.9, Corollary 1.10, the algorithms of Theorem 1.11 *do not depend* on the somewhat difficult (e.g., in their use of *p-adic Hodge theory*) results of [Mzk5]. Put another way, this elementary nature of Theorem 1.11 serves to highlight the fact that the *only non-elementary portion* (in the sense of its dependence of the results of [Mzk5]) of the algorithms of Theorem 1.9 is the use of the technique of *Belyi cuspidalizations*. It is precisely this “non-elementary portion” of Theorem 1.9 that requires us, in Theorem 1.9, to assume that the base field is *sub-p-adic* (i.e., as opposed to merely *Kummer-faithful*, as in Theorem 1.11).

REMARK 1.11.4.

(i) The observation of Remark 1.11.3 prompts the following question:

If the *birational* version (i.e., Theorem 1.11) of Theorem 1.9 is so much more elementary than Theorem 1.9, then what is the *advantage* (i.e., relative to the anabelian geometry of function fields) of considering the *anabelian geometry of hyperbolic curves*?

One key advantage of working with hyperbolic curves, in the context of the theory of the present paper, lies in the fact that “most” hyperbolic curves admit a *core* (cf. [Mzk3], §3; [Mzk10], §2). Moreover, the existence of “cores” at the level of schemes has a tendency to imply to existence of “cores” at the level of “étale fundamental groups considered geometrically”, i.e., at the level of *anabelioids* (cf. [Mzk11], §3.1). The existence of a core is *crucial* to, for instance, the theory of the *étale theta function* given in [Mzk18], §1, §2, and, moreover, in the present three-part series, plays an important role in the theory of *elliptically admissible* (cf. [Mzk21], Definition 3.1) hyperbolic orbicurves. On the other hand, it is easy to see that “*function fields do not admit cores*”: i.e., if, in the notation of Theorem 1.11, we write  $\text{Loc}(\eta_X)$  for the category whose *objects* are connected schemes that admit a connected finite étale covering which is also a connected finite étale covering of  $\eta_X$ , and whose *morphisms* are the finite étale morphisms, then  $\text{Loc}(\eta_X)$  *fails to admit a terminal object*.

(ii) The observation of (i) is interesting in the context of the theory of §5 below, in which we apply various (mono-)anabelian results to construct “*canonical rigid integral structures*” called “*log-shells*”. Indeed, in the Introduction to [Mzk11], it is explained, via analogy to the complex analytic



theory of the upper half-plane, how the notion of a *core* may be thought of as a sort of “*canonical integral structure*” — i.e., relative to the “modifications of integral structure” constituted by “going up and down via various finite étale coverings”. Here, it is interesting to note that this idea of a “canonical integral structure relative to going up and down via finite étale coverings” may also be seen in the theory surrounding the property of *cyclotomic rigidity* in the context of the *étale theta function* (cf., e.g., [Mzk18], Remark 2.19.3). Moreover, let us observe that these “integral structures with respect to finite étale coverings” may be thought of as “*exponentiated integral structures*” — i.e., in the sense that, for instance, in the case of  $\mathbb{G}_m$  over  $\mathbb{Q}$ , these integral structures are not integral structures relative to the scheme-theoretic base ring  $\mathbb{Z} \subseteq \mathbb{Q}$ , but rather with respect to the *exponent* of the standard coordinate  $U$ , which, via multiplication by various nonnegative integers  $N$ , gives rise, in the form of mappings  $U^n \mapsto U^{N \cdot n}$ , to various finite étale coverings of  $\mathbb{G}_m$ . Such “*non-scheme-theoretic exponentiated copies of  $\mathbb{Z}$* ” play an important role in the theory of the étale theta function as the Galois group of a certain natural infinite étale covering of the Tate curve — cf. the discussion of [Mzk18], Remark 2.16.2. Moreover, the idea of constructing “canonical integral structures” by “*de-exponentiating* certain exponentiated integral structures” may be rephrased as the idea of “constructing canonical integral structures by applying some sort of *logarithm* operation”. From this point of view, such “canonical integral structures with respect to finite étale coverings” are quite reminiscent of the *canonical integral structures arising from log-shells* to be constructed in §5 below.

REMARK 1.11.5. In the context of the discussion of Remark 1.11.4, if the hyperbolic curve in question is *affine*, then, relative to the *function field* of the curve, the *additional data* necessary to determine the given affine hyperbolic curve consists precisely of some (nonempty) finite collection of conjugacy classes of *inertia groups* (i.e., “ $I_x$ ” as in Theorem 11.1, (b)). Thus, from the point of view of the discussion of Remark 1.11.3, the technique of *Belyi cuspidalizations* is applied precisely so as to enable one to work with this *additional data* (cf. also the discussion of Remark 3.7.7 below).

## Section 2. Archimedean Reconstruction Algorithms

In the present §2, we re-examine various aspects of the *complex analytic* theory of [Mzk14] from an *algorithm-based*, “*model-implicit*” (cf. Remark 2.7.4 below) point of view motivated by the *Galois-theoretic* theory of §1. More precisely, the “*SL<sub>2</sub>(ℝ)-based approach*” of [Mzk14], §1, may be seen in the *general theory of Aut-holomorphic spaces* given in Proposition 2.2, Corollary 2.3, while the “*parallelograms, rectangles, squares approach*” of [Mzk14], §2, is developed further in the reconstruction algorithms of Propositions 2.5, 2.6. These two approaches are combined to obtain the main result of the present §2 (cf. Corollary 2.7), which consists of a certain reconstruction algorithm for the “*local linear holomorphic structure*” of an Aut-holomorphic orbispace arising from an *elliptically admissible* hyperbolic orbicurve. Finally, in Corollaries 2.8, 2.9, we consider the relationship between Corollary 2.7 and the *global portion* of the Galois-theoretic theory of §1.

The following definition will play an important role in the theory of the present §2.

DEFINITION 2.1.

(i) Let  $X$  be a *Riemann surface* (i.e., a complex manifold of dimension one). Write  $\mathcal{A}_X$  for the assignment that assigns to each connected open subset  $U \subseteq X$  the group

$$\mathcal{A}_X(U) \stackrel{\text{def}}{=} \text{Aut}^{\text{hol}}(U)$$

of *holomorphic automorphisms* of  $U$  — which we think of as being “some distinguished subgroup” of the group of self-homeomorphisms  $\text{Aut}(U^{\text{top}})$  of the underlying topological space  $U^{\text{top}}$  of  $U$ . We shall refer to as the *Aut-holomorphic space* associated to  $X$  the pair

$$\mathbb{X} \stackrel{\text{def}}{=} (\mathbb{X}^{\text{top}}, \mathcal{A}_{\mathbb{X}})$$

consisting of the *underlying topological space*  $\mathbb{X}^{\text{top}} \stackrel{\text{def}}{=} X^{\text{top}}$  of  $X$ , together with the *assignment*  $\mathcal{A}_{\mathbb{X}} \stackrel{\text{def}}{=} \mathcal{A}_X$ ; also, we shall refer to the assignment  $\mathcal{A}_{\mathbb{X}} = \mathcal{A}_X$  as the *Aut-holomorphic structure* on  $\mathbb{X}^{\text{top}} = X^{\text{top}}$  (determined by  $\mathbb{X}$ ). If  $X$  is biholomorphic to the open unit disc, then we shall refer to  $\mathbb{X}$

as an *Aut-holomorphic disc*. If  $X$  is a hyperbolic Riemann surface of finite type (respectively, a hyperbolic Riemann surface of finite type associated to an elliptically admissible (cf. [Mzk21], Definition 3.1) hyperbolic curve over  $\mathbb{C}$ ), then we shall refer to the Aut-holomorphic space  $\mathbb{X}$  as *hyperbolic of finite type* (respectively, *elliptically admissible*). If  $\mathcal{U}$  is a collection of connected open subsets of  $X$  that forms a *basis* for the topology of  $X$  and, moreover, satisfies the condition that any connected open subset of  $X$  that is contained in an element of  $\mathcal{U}$  is itself an element of  $\mathcal{U}$ , then we shall refer to  $\mathcal{U}$  as a *local structure* on  $X^{\text{top}}$  and to the restriction  $\mathcal{A}_{\mathbb{X}}|_{\mathcal{U}}$  of  $\mathcal{A}_{\mathbb{X}}$  to  $\mathcal{U}$  as a *( $\mathcal{U}$ -local) pre-Aut-holomorphic structure* on  $X^{\text{top}}$ .

(ii) Let  $X$  (respectively,  $Y$ ) be a *Riemann surface*;  $\mathbb{X}$  (respectively,  $\mathbb{Y}$ ) the *Aut-holomorphic space* associated to  $X$  (respectively,  $Y$ );  $\mathcal{U}$  (respectively,  $\mathcal{V}$ ) a *local structure* on  $\mathbb{X}^{\text{top}}$  (respectively,  $\mathbb{Y}^{\text{top}}$ ). Then we shall refer to as a *( $\mathcal{U}, \mathcal{V}$ )-local morphism of Aut-holomorphic spaces*

$$\phi : \mathbb{X} \rightarrow \mathbb{Y}$$

any local isomorphism of topological spaces  $\phi^{\text{top}} : \mathbb{X}^{\text{top}} \rightarrow \mathbb{Y}^{\text{top}}$  with the property that for any open subset  $U_{\mathbb{X}} \in \mathcal{U}$  that maps *homeomorphically* via  $\phi^{\text{top}}$  onto some open subset  $U_{\mathbb{Y}} \in \mathcal{V}$ ,  $\phi^{\text{top}}$  induces a bijection  $\mathcal{A}_{\mathbb{X}}(U_{\mathbb{X}}) \xrightarrow{\sim} \mathcal{A}_{\mathbb{Y}}(U_{\mathbb{Y}})$ ; when  $\mathcal{U}, \mathcal{V}$  are, respectively, the sets of all connected open subsets of  $X, Y$ , then we shall omit the word “( $\mathcal{U}, \mathcal{V}$ )-local” from this terminology; when  $\phi^{\text{top}}$  is a finite covering space map, we shall say that  $\phi$  is *finite étale*. We shall refer to a map  $X \rightarrow Y$  which is either holomorphic or anti-holomorphic at each point of  $X$  as an *RC-holomorphic morphism* (cf. [Mzk14], Definition 1.1, (vi)).

(iii) Let  $Z, Z'$  be *orientable topological surfaces* (i.e., two-manifolds). If  $p \in Z$ , then let us write

$$\text{Orn}(Z, p) \stackrel{\text{def}}{=} \varinjlim_W \pi_1(W \setminus \{p\})^{\text{ab}}$$

— where  $W$  ranges over the *connected open neighborhoods* of  $p$  in  $Z$ ; “ $\pi_1(-)$ ” denotes the usual topological fundamental group, relative to some base-point (so “ $\pi_1(-)$ ” is only defined up to *inner automorphisms*, an indeterminacy which may be eliminated by passing to the *abelianization* “ab”); thus,  $\text{Orn}(Z, p)$  is (*noncanonically!*) isomorphic to  $\mathbb{Z}$ . Note that since  $Z$  is

*orientable*, it follows that the assignment  $p \mapsto \text{Orn}(Z, p)$  determines a *trivial local system* on  $Z$ , whose module of global sections we shall denote by  $\text{Orn}(Z)$  (so  $\text{Orn}(Z)$  is a direct product of copies of  $\mathbb{Z}$ , indexed by the connected components of  $Z$ ). One verifies immediately that any local isomorphism  $Z \rightarrow Z'$  induces a well-defined homomorphism  $\text{Orn}(Z) \rightarrow \text{Orn}(Z')$ . We shall say that any two local isomorphisms  $\alpha, \beta : Z \rightarrow Z'$  are *co-oriented* if they induce the *same homomorphism*  $\text{Orn}(Z) \rightarrow \text{Orn}(Z')$ . We shall refer to as a *pre-co-orientation*  $\zeta : Z \rightarrow Z'$  any *equivalence class* of local isomorphisms  $Z \rightarrow Z'$  relative to the equivalence relation determined by the property of being co-oriented (so a pre-co-orientation may be thought of as a *collection of maps*  $Z \rightarrow Z'$ , or, alternatively, as a *homomorphism*  $\text{Orn}(Z) \rightarrow \text{Orn}(Z')$ ). Thus, the pre-co-orientations from the open subsets of  $Z$  to  $Z'$  form a *pre-sheaf* on  $Z$ ; we shall refer to as a *co-orientation*

$$\zeta : Z \rightarrow Z'$$

any section of the sheafification of this pre-sheaf (so a co-orientation may be thought of as a *collection of maps* from open subsets of  $Z$  to  $Z'$ , or, alternatively, as a *homomorphism*  $\text{Orn}(Z) \rightarrow \text{Orn}(Z')$ ).

(iv) Let  $X, Y, \mathbb{X}, \mathbb{Y}, \mathcal{U}, \mathcal{V}$  be as in (ii). Then we shall say that two  $(\mathcal{U}, \mathcal{V})$ -local morphisms of Aut-holomorphic spaces  $\phi_1, \phi_2 : \mathbb{X} \rightarrow \mathbb{Y}$  are *co-holomorphic* if  $\phi_1^{\text{top}}$  and  $\phi_2^{\text{top}}$  are co-oriented (cf. (iii)). We shall refer to as a *pre-co-holomorphicization*  $\zeta : \mathbb{X} \rightarrow \mathbb{Y}$  any *equivalence class* of  $(\mathcal{U}, \mathcal{V})$ -local morphisms of Aut-holomorphic spaces  $\mathbb{X} \rightarrow \mathbb{Y}$  relative to the equivalence relation determined by the property of being co-holomorphic (so a pre-co-holomorphicization may be thought of as a *collection of maps* from  $\mathbb{X}^{\text{top}}$  to  $\mathbb{Y}^{\text{top}}$ ). Thus, the pre-co-holomorphicizations from the Aut-holomorphic spaces determined by open subsets of  $\mathbb{X}^{\text{top}}$  to  $\mathbb{Y}$  form a *pre-sheaf* on  $\mathbb{X}^{\text{top}}$ ; we shall refer to as a *co-holomorphicization* (cf. also Remark 2.3.2 below)

$$\zeta : \mathbb{X} \rightarrow \mathbb{Y}$$

any section of the sheafification of this pre-sheaf (so a co-holomorphicization may be thought of as a *collection of maps* from open subsets of  $\mathbb{X}^{\text{top}}$  to  $\mathbb{Y}^{\text{top}}$ ). Finally, we observe that every co-holomorphicization (respectively, pre-co-holomorphicization) determines a *co-orientation* (*pre-co-orientation*) *between the underlying topological spaces*.

REMARK 2.1.1. One verifies immediately that there is a natural extension of the notions of Definition 2.1 to the case of *Riemann orbisurfaces*, which give rise to “Aut-holomorphic orbispaces” (not to be confused with the “orbi-objects” of §0, which will always be identifiable in the present paper by means of the *hyphen* “-” following the prefix “orbi”). Here, we understand the term “Riemann orbisurface” to refer to a one-dimensional complex analytic stack which is *locally isomorphic* to the complex analytic stack obtained by forming the *stack-theoretic quotient* of a Riemann surface (i.e., a one-dimensional complex manifold) by a *finite group of (holomorphic) automorphisms* (of the Riemann surface). In particular, a “Riemann orbisurface” is necessarily a Riemann surface over the complement, in the “coarse space” associated to the orbisurface, of some *discrete closed subset*.

REMARK 2.1.2. One important aspect of the “Aut-holomorphic” approach to the notion of a “*holomorphic structure*” is that this approach has the virtue of being free of any mention of some “*fixed reference model*” copy of the field of complex numbers  $\mathbb{C}$  — cf. Remark 2.7.4 below.

PROPOSITION 2.2 (Commensurable Terminality of RC-Holomorphic Automorphisms of the Disc). *Let  $\mathbb{X}, \mathbb{Y}$  be Aut-holomorphic discs, arising, respectively, from Riemann surfaces  $X, Y$ . Then:*

- (i) *Every isomorphism of Aut-holomorphic spaces  $\mathbb{X} \xrightarrow{\sim} \mathbb{Y}$  arises from a unique RC-holomorphic isomorphism  $X \xrightarrow{\sim} Y$ .*
- (ii) *Let us regard the group  $\text{Aut}(X^{\text{top}})$  as equipped with the compact-open topology. Then the subgroup*

$$\text{Aut}^{\text{RC-hol}}(X) \subseteq \text{Aut}(X^{\text{top}})$$

*of RC-holomorphic automorphisms of  $X$ , which (as is well-known) contains  $\text{Aut}^{\text{hol}}(X)$  as a subgroup of index two, is closed and commensurably terminal (cf. [Mzk20], §0). Moreover, we have isomorphisms of topological groups*

$$\text{Aut}^{\text{hol}}(X) \cong SL_2(\mathbb{R})/\{\pm 1\}; \quad \text{Aut}^{\text{RC-hol}}(X) \cong GL_2(\mathbb{R})/\mathbb{R}^\times$$

*(where we regard  $\text{Aut}^{\text{hol}}(X), \text{Aut}^{\text{RC-hol}}(X)$ , as equipped with the topology induced by the topology of  $\text{Aut}(X^{\text{top}})$ , i.e., the compact-open topology).*

PROOF. It is immediate from the definitions that assertion (i) follows formally from the *commensurable terminality* (in fact, in this situation, *normal terminality* suffices) of assertion (ii). Thus, it suffices to verify assertion (ii). First, we recall that we have a natural *isomorphism of connected topological groups*

$$\mathrm{Aut}^{\mathrm{hol}}(X) \cong SL_2(\mathbb{R})/\{\pm 1\}$$

(where we regard  $\mathrm{Aut}^{\mathrm{hol}}(X)$  as equipped with the *compact-open topology*). Next, let us recall the well-known fact in elementary complex analysis that “a sequence of holomorphic functions on  $X^{\mathrm{top}}$  that converges uniformly on compact subsets of  $X^{\mathrm{top}}$  converges to a holomorphic function on  $X^{\mathrm{top}}$ ”. (This fact is often applied in proofs of the *Riemann mapping theorem*.) This fact implies immediately that  $\mathrm{Aut}^{\mathrm{hol}}(X)$ ,  $\mathrm{Aut}^{\mathrm{RC-hol}}(X)$  are closed in  $\mathrm{Aut}(X^{\mathrm{top}})$ . Now suppose that  $\alpha \in \mathrm{Aut}(X^{\mathrm{top}})$  lies in the *commensurator* of  $\mathrm{Aut}^{\mathrm{hol}}(X)$ ; thus, the intersection  $(\alpha \cdot \mathrm{Aut}^{\mathrm{hol}}(X) \cdot \alpha^{-1}) \cap \mathrm{Aut}^{\mathrm{hol}}(X)$  is a closed subgroup of finite index of  $\mathrm{Aut}^{\mathrm{hol}}(X)$ . But this implies that  $(\alpha \cdot \mathrm{Aut}^{\mathrm{hol}}(X) \cdot \alpha^{-1}) \cap \mathrm{Aut}^{\mathrm{hol}}(X)$  is an open subgroup of  $\mathrm{Aut}^{\mathrm{hol}}(X)$ , hence (since  $\mathrm{Aut}^{\mathrm{hol}}(X)$  is *connected*) that  $(\alpha \cdot \mathrm{Aut}^{\mathrm{hol}}(X) \cdot \alpha^{-1}) \cap \mathrm{Aut}^{\mathrm{hol}}(X) = \mathrm{Aut}^{\mathrm{hol}}(X)$ , i.e., that  $\alpha \cdot \mathrm{Aut}^{\mathrm{hol}}(X) \cdot \alpha^{-1} \supseteq \mathrm{Aut}^{\mathrm{hol}}(X)$ . Thus, by replacing  $\alpha$  by  $\alpha^{-1}$ , we conclude that  $\alpha$  *normalizes*  $\mathrm{Aut}^{\mathrm{hol}}(X)$ , i.e., that  $\alpha$  induces an automorphism of the topological group  $\mathrm{Aut}^{\mathrm{hol}}(X) \cong SL_2(\mathbb{R})/\{\pm 1\}$ , hence also (by *Cartan’s theorem* — cf., e.g., [Serre], Chapter V, §9, Theorem 2; the proof of [Mzk14], Lemma 1.10) of the *real analytic Lie group*  $SL_2(\mathbb{R})/\{\pm 1\}$ . Thus, as is well-known, it follows (for instance, by considering the action of  $\alpha$  on the *Borel subalgebras* of the complexification of the Lie algebra of  $SL_2(\mathbb{R})/\{\pm 1\}$ ) that  $\alpha$  arises from an element of  $GL_2(\mathbb{C})/\mathbb{C}^\times$  that fixes (relative to the action by conjugation) the Lie subalgebra  $sl_2(\mathbb{R})$  of  $sl_2(\mathbb{C})$ . But such an element of  $GL_2(\mathbb{C})/\mathbb{C}^\times$  is easily verified to be an element of  $GL_2(\mathbb{R})/\mathbb{R}^\times$ . In particular, by considering the action of  $\alpha$  on *maximal compact subgroups* of  $\mathrm{Aut}^{\mathrm{hol}}(X)$  (cf. the proof of [Mzk14], Lemma 1.10), it follows that  $\alpha$  arises from an *RC-holomorphic automorphism* of  $X$ , as desired.  $\square$

In fact, as the following result shows, the notions of an *Aut-holomorphic structure* and a *pre-Aut-holomorphic structure* are equivalent to one another, as well as to the usual notion of a “*holomorphic structure*”.

COROLLARY 2.3 (Morphisms of Aut-Holomorphic Spaces). *Let  $X$  (respectively,  $Y$ ) be a Riemann surface;  $\mathbb{X}$  (respectively,  $\mathbb{Y}$ ) the Aut-holomor-*

phic space associated to  $X$  (respectively,  $Y$ );  $\mathcal{U}$  (respectively,  $\mathcal{V}$ ) a local structure on  $\mathbb{X}^{\text{top}}$  (respectively,  $\mathbb{Y}^{\text{top}}$ ). Then:

(i) Every  $(\mathcal{U}, \mathcal{V})$ -local morphism of Aut-holomorphic spaces

$$\phi : \mathbb{X} \rightarrow \mathbb{Y}$$

arises from a unique étale RC-holomorphic morphism  $\psi : X \rightarrow Y$ . Moreover, if, in this situation,  $\mathbb{X}, \mathbb{Y}$  (i.e.,  $\mathbb{X}^{\text{top}}, \mathbb{Y}^{\text{top}}$ ) are connected, then there exist precisely two co-holomorphicizations  $\mathbb{X} \rightarrow \mathbb{Y}$ , corresponding to the holomorphic and anti-holomorphic local isomorphisms from open subsets of  $X$  to  $Y$ .

(ii) Every pre-Aut-holomorphic structure on  $\mathbb{X}^{\text{top}}$  extends to a unique Aut-holomorphic structure on  $\mathbb{X}^{\text{top}}$ .

PROOF. Assertion (i) follows immediately from the definitions, by applying Proposition 2.2, (i), to *sufficiently small open discs* in  $\mathbb{X}^{\text{top}}$ . Assertion (ii) follows immediately from assertion (i) by applying assertion (i) to automorphisms of the Aut-holomorphic spaces determined by *arbitrary connected open subsets* of  $\mathbb{X}^{\text{top}}$  which determine the *same co-holomorphicization* as the identity automorphism.  $\square$

REMARK 2.3.1. Note that Corollary 2.3 may be thought of as one sort of “*complex analytic analogue of the Grothendieck Conjecture*”, that, although formulated somewhat differently, contains (to a substantial extent) the *same essential mathematical content* as [Mzk14], Theorem 1.12 — cf. the similarity between the proofs of Proposition 2.2 and [Mzk14], Lemma 1.10; the application of the *p-adic version of Cartan’s theorem* in the proof of [Mzk8], Theorem 1.1 (i.e., in the proof of [Mzk8], Lemma 1.3).

REMARK 2.3.2. It follows, in particular, from Corollary 2.3, (ii), that (in the notation of Definition 2.1, (iv)) the notion of a *co-holomorphicization*  $\mathbb{X} \rightarrow \mathbb{Y}$  is, in fact, *independent* of the choice of the *local structures*  $\mathcal{U}, \mathcal{V}$ .

REMARK 2.3.3. It follows immediately from Corollary 2.3, (i), that any *composite* of morphisms of Aut-holomorphic spaces is again a *morphism of Aut-holomorphic spaces*.

COROLLARY 2.4 (Holomorphic Arithmeticity and Cores). *Let  $\mathbb{X}$  be a hyperbolic Aut-holomorphic space of finite type associated to a Riemann*

surface  $X$  (which is, in turn, determined by a hyperbolic curve over  $\mathbb{C}$ ). Then one may determine the arithmeticity (in the sense of [Mzk3], §2) of  $X$  and, when  $X$  is not arithmetic, construct the Aut-holomorphic orbispace (cf. Remark 2.1.1) associated to the hyperbolic core (cf. [Mzk3], Definition 3.1) of  $X$ , via the following functorial algorithm, which involves only the Aut-holomorphic space  $\mathbb{X}$  as input data:

- (a) Let  $\mathbb{U}^{\text{top}} \rightarrow \mathbb{X}^{\text{top}}$  be any universal covering of  $\mathbb{X}^{\text{top}}$  (i.e., a connected covering space of the topological space  $\mathbb{X}^{\text{top}}$  which does not admit any nontrivial connected covering spaces). Then one may construct the fundamental group  $\pi_1(\mathbb{X}^{\text{top}})$  as the group of automorphisms  $\text{Aut}(\mathbb{U}^{\text{top}}/\mathbb{X}^{\text{top}})$  of  $\mathbb{U}^{\text{top}}$  over  $\mathbb{X}^{\text{top}}$ .
- (b) In the notation of (a), by considering the local structure on  $\mathbb{U}^{\text{top}}$  consisting of connected open subsets of  $\mathbb{U}^{\text{top}}$  that map isomorphically onto open subsets of  $\mathbb{X}^{\text{top}}$ , one may construct a natural pre-Aut-holomorphic structure on  $\mathbb{U}^{\text{top}}$  — hence also (cf. Corollary 2.3, (ii)) a natural Aut-holomorphic structure on  $\mathbb{U}^{\text{top}}$  — by restricting the Aut-holomorphic structure of  $\mathbb{X}$  on  $\mathbb{X}^{\text{top}}$ ; denote the resulting Aut-holomorphic space by  $\mathbb{U}$ . Thus, we obtain a natural injection

$$\pi_1(\mathbb{X}^{\text{top}}) = \text{Aut}(\mathbb{U}^{\text{top}}/\mathbb{X}^{\text{top}}) \hookrightarrow \text{Aut}^0(\mathbb{U}) \subseteq \text{Aut}(\mathbb{U})$$

— where we recall (cf. Proposition 2.2, (ii); Corollary 2.3, (i)) that  $\text{Aut}(\mathbb{U})$ , equipped with the compact-open topology, is isomorphic, as a topological group, to  $GL_2(\mathbb{R})/\mathbb{R}^\times$ ; we write  $\text{Aut}^0(\mathbb{U}) \subseteq \text{Aut}(\mathbb{U})$  for the connected component of the identity of  $\text{Aut}(\mathbb{U})$ .

- (c) In the notation of (b),  $X$  is not arithmetic if and only if the image of  $\pi_1(\mathbb{X}^{\text{top}})$  in  $\text{Aut}^0(\mathbb{U})$  is of finite index in its commensurator  $\Pi \subseteq \text{Aut}^0(\mathbb{U})$  in  $\text{Aut}^0(\mathbb{U})$  (cf. [Mzk3], §2, §3). If  $X$  is not arithmetic, then the Aut-holomorphic orbispace

$$\mathbb{X} \rightarrow \mathbb{H}$$

associated to the hyperbolic core  $H$  of  $X$  may be constructed by forming the “orbispace quotient” of  $\mathbb{U}^{\text{top}}$  by  $\Pi$  and equipping this quotient with the pre-Aut-holomorphic structure — which (cf.



Corollary 2.3, (ii)) determines a unique Aut-holomorphic structure — determined by restricting the Aut-holomorphic structure of  $\mathbb{U}$  to some suitable local structure as in (b).

Finally, the asserted “functoriality” is with respect to finite étale morphisms of Aut-holomorphic spaces arising from hyperbolic curves over  $\mathbb{C}$ .

PROOF. The validity of the algorithm asserted in Corollary 2.4 is immediate from the constructions that appear in the statement of this algorithm (together with the references quoted in these constructions).  $\square$

REMARK 2.4.1. One verifies immediately that Corollary 2.4 admits a natural extension to the case where  $X$  arises from a *hyperbolic orbicurve* over  $\mathbb{C}$  (cf. Remark 2.1.1).

REMARK 2.4.2. Relative to the analogy with the theory of §1 (cf. Remark 2.7.3 below), Corollary 2.4 may be regarded as a sort of *holomorphic analogue* of results such as [Mzk10], Theorem 2.4, concerning *categories of finite étale localizations* of hyperbolic orbicurves.

Next, we turn our attention to re-examining, from an *algorithm-based* point of view, the theory of *affine linear structures on Riemann surfaces* in the style of [Mzk14], §2; [Mzk14], Appendix. Following the terminology of [Mzk14], Definition A.3, (i), (ii), we shall refer to as “*parallelograms*”, “*rectangles*”, or “*squares*” the distinguished *open subsets* of  $\mathbb{C} = \mathbb{R} + i\mathbb{R}$  which are of the form suggested by these respective terms.

PROPOSITION 2.5 (Linear Structures via Parallelograms, Rectangles, or Squares). *Let*

$$U \subseteq \mathbb{C} = \mathbb{R} + i\mathbb{R}$$

*be a connected open subset. Write*

$$\mathcal{S}(U) \subseteq \mathcal{R}(U) \subseteq \mathcal{P}(U)$$

*for the sets of pre-compact squares, rectangles, and parallelograms in  $U$ ; let  $\mathcal{Q} \in \{\mathcal{S}, \mathcal{R}, \mathcal{P}\}$ . Then there exists a functorial algorithm for constructing the parallel line segments, parallelograms, orientations, and “local additive structures” (in the sense described below) of  $U$  that involves only the input*

data  $(U, \mathcal{Q}(U))$  — i.e., consisting of the abstract set  $U$ , equipped with the datum of a collection of distinguished open subsets  $\mathcal{Q}(U)$  (which clearly forms a basis for, hence determines, the topology of  $U$ ) — as follows:

- (a) Define a strict line segment  $L$  of  $U$  to be an intersection of the form

$$L \stackrel{\text{def}}{=} \overline{Q_1} \cap \overline{Q_2}$$

— where  $\overline{Q_1}, \overline{Q_2}$  are the respective closures of  $Q_1, Q_2 \in \mathcal{Q}(U)$ ;  $Q_1 \cap Q_2 = \emptyset$ ;  $L$  is of infinite cardinality. Define two strict line segments to be strictly collinear if their intersection is of infinite cardinality. Define a strict chain of  $U$  to be a finite ordered set of strict line segments  $L_1, \dots, L_n$  (where  $n \geq 2$  is an integer) such that  $L_i, L_{i+1}$  are strictly collinear for  $i = 1, \dots, n-1$ . Then one constructs the (closed, bounded) line segments of  $U$  by observing that a line segment may be characterized as the union of strict line segments contained a strict chain of  $U$ ; an endpoint of a line segment  $L$  is a point of the boundary  $\partial L$  of  $L$  (i.e., a point whose complement in  $L$  is connected).

- (b) Define a  $\partial\mathcal{Q}$ -parallelogram of  $U$  to be a closed subset of  $U$  of the form  $\partial Q \stackrel{\text{def}}{=} \overline{Q} \setminus Q$  — where  $Q \in \mathcal{Q}(U)$ ;  $\overline{Q}$  denotes the closure of  $Q$ . Define a side of a parallelogram  $Q \in \mathcal{Q}(U)$  to be a maximal line segment contained in the  $\partial\mathcal{Q}$ -parallelogram  $\partial Q$ . Define two line segments  $L, L'$  of  $U$  to be strictly parallel if there exist non-intersecting sides  $S, S'$  of a parallelogram  $Q \in \mathcal{Q}(U)$  such that  $S \subseteq L, S' \subseteq L'$ . Then one constructs the pairs  $(L, L')$  of parallel line segments by observing that  $L, L'$  are parallel if and only if  $L$  is equivalent to  $L'$  relative to the equivalence relation on line segments generated by the relation of inclusion and the relation of being strictly parallel.

- (c) Define a pre- $\partial$ -parallelogram  $\partial P$  of  $U$  to be a union of the members of a family of four line segments  $\{L_i\}_{i \in \mathbb{Z}/4\mathbb{Z}}$  of  $U$  such that for any two distinct points  $p_1, p_2 \in \partial P$ , there exists a line segment  $L$  such that  $\partial L = \{p_1, p_2\}$ , and, moreover, for each  $i \in \mathbb{Z}/4\mathbb{Z}$ ,  $L_i$  and  $L_{i+2}$  are parallel and non-intersecting, and we have an equality of sets  $L_i \cap L_{i+1} = (\partial L_i) \cap (\partial L_{i+1})$  of cardinality one. If  $\partial P$  is a pre- $\partial$ -parallelogram of  $U$ , then define

the associated pre-parallelogram of  $U$  to be the union of line segments  $L$  of  $U$  such  $\partial L \subseteq \partial P$ . Then one constructs the parallelograms  $\in \mathcal{P}(U)$  of  $U$  as the interiors of the pre-parallelograms of  $U$ .

(d) Let  $p \in U$ . Define a frame  $F = (S_1, S_2)$  of  $U$  at  $p$  to be an ordered pair of distinct intersecting sides  $S_1, S_2$  of a parallelogram  $P \in \mathcal{P}(U)$  such that  $S_1 \cap S_2 = \{p\}$ ; in this situation, we shall refer to any line segment of  $U$  that has infinite intersection with  $P$  as being framed by  $F$ . Define two frames  $F = (S_1, S_2)$ ,  $F' = (S'_1, S'_2)$  of  $U$  at  $p$  to be strictly co-oriented if  $S'_1$  is framed by  $F$ , and  $S_2$  is framed by  $F'$ . Then one constructs the orientations of  $U$  at  $p$  (of which there are precisely 2) by observing that an orientation of  $U$  at  $p$  may be characterized as an equivalence class of frames of  $U$  at  $p$ , relative to the equivalence relation on frames of  $U$  at  $p$  generated by the relation of being strictly co-oriented.

(e) Let  $p \in U$ . Then given  $a, b \in U$ , the sum  $a +_p b \in U$ , relative to the origin  $p$  — i.e., the “local additive structure” of  $U$  at  $p$  — may be constructed, whenever it is defined, in the following fashion: If  $a = p$ , then  $a +_p b = b$ ; if  $b = p$ , then  $a +_p b = a$ . If  $a, b \neq p$ , then for  $P \in \mathcal{P}(U)$  such that  $P$  contains (distinct) intersecting sides  $S_a, S_b$  for which  $S_a \cap S_b = \{p\}$ ,  $\partial S_a = \{p, a\}$ ,  $\partial S_b = \{p, b\}$ , we take  $a +_p b$  to be the unique endpoint of a side of  $P$  that  $\notin \{a, b, p\}$ . (Thus, “ $a +_p b$ ” is defined for  $a, b$  in some neighborhood of  $p$  in  $U$ .)

Finally, the asserted “functoriality” is with respect to open immersions (of abstract topological spaces)  $\iota : U_1 \hookrightarrow U_2$  (where  $U_1, U_2 \subseteq \mathbb{C}$  are connected open subsets) such that  $\iota$  maps  $\mathcal{Q}(U_1)$  into  $\mathcal{Q}(U_2)$ .

PROOF. The validity of the algorithm asserted in Proposition 2.5 is immediate from the elementary content of the characterizations contained in the statement of this algorithm.  $\square$

REMARK 2.5.1. We shall refer to a frame of  $U$  at  $p \in U$  as *orthogonal* if it arises from an ordered pair of distinct intersecting sides of a *rectangle*  $\in \mathcal{R}(U) \subseteq \mathcal{P}(U)$ .

PROPOSITION 2.6 (Local Linear Holomorphic Structures via Rectangles or Squares). *Let  $U, \mathcal{S}, \mathcal{R}, \mathcal{P}, \mathcal{Q}$  be as in Proposition 2.5; suppose further that  $\mathcal{Q} \neq \mathcal{P}$ . Then there exists a functorial algorithm for constructing the “local linear holomorphic structure” (in the sense described below) of  $U$  that involves only the input data  $(U, \mathcal{Q}(U))$  — i.e., consisting of the abstract topological space  $U$ , equipped with the datum of a collection of distinguished open subsets  $\mathcal{Q}(U)$  — as follows:*

(a) *For  $p \in U$ , write*

$$\mathcal{A}_p$$

*for the group of automorphisms of the projective system of connected open neighborhoods of  $p$  in  $U$  that are compatible with the “local additive structures” of Proposition 2.5, (e), and preserve the orthogonal frames and orientations (at  $p$ ) of Proposition 2.5, (d); Remark 2.5.1. Also, we equip  $\mathcal{A}_p$  with the topology induced by the topologies of the open neighborhoods of  $p$  that  $\mathcal{A}_p$  acts on; note that the “local additive structures” of Proposition 2.5, (e), determine an additive structure, hence also a topological field structure on  $\mathcal{A}_p \cup \{0\}$ . Then we have a natural isomorphism of topological groups*

$$\mathbb{C}^\times \xrightarrow{\sim} \mathcal{A}_p$$

*(induced by the tautological action of  $\mathbb{C}^\times$  on  $\mathbb{C} \supseteq U$ ) that is compatible with the topological field structures on the union of either side with “ $\{0\}$ ”. In particular, one may construct “ $\mathbb{C}^\times$  at  $p$ ” — i.e., the “local linear holomorphic structure” of  $U$  at  $p$  — by thinking of this “local linear holomorphic structure” as being constituted by the topological field  $\mathcal{A}_p \cup \{0\}$ , equipped with its tautological action on the projective system of open neighborhoods of  $p$ .*

(b) *For  $p, p' \in U$ , one constructs a natural isomorphism of topological groups*

$$\mathcal{A}_p \xrightarrow{\sim} \mathcal{A}_{p'}$$

*that is compatible with the topological field structures on either side as follows: If  $p'$  is sufficiently close to  $p$ , then the “local additive structures” of Proposition 2.5, (e), determine homeomorphisms (by “translation”, i.e., “addition”) from sufficiently*

small neighborhoods of  $p$  onto sufficiently small neighborhoods of  $p'$ ; these homeomorphisms thus induce the desired isomorphism  $\mathcal{A}_p \xrightarrow{\sim} \mathcal{A}_{p'}$ . Now, by joining an arbitrary  $p'$  to  $p$  via a chain of “sufficiently small open neighborhoods” and composing the resulting isomorphisms of “local linear holomorphic structures”, one obtains the desired isomorphism  $\mathcal{A}_p \xrightarrow{\sim} \mathcal{A}_{p'}$  for arbitrary  $p, p' \in U$ . Finally, this isomorphism is independent of the choice of a chain of “sufficiently small open neighborhoods” used in its construction.

Finally, the asserted “functoriality” is to be understood in the same sense as in Proposition 2.5.

PROOF. The validity of the algorithm asserted in Proposition 2.6 is immediate from the elementary content of the characterizations contained in the statement of this algorithm.  $\square$

REMARK 2.6.1. Thus, the *algorithms* of Propositions 2.5, 2.6 may be regarded as superseding the techniques applied in the proof of [Mzk14], Proposition A.4. Moreover, just as the theory of [Mzk14], Appendix, was applied in [Mzk14], §2, one may apply the algorithms of Propositions 2.5, 2.6 to give algorithms for *reconstructing the local linear and orthogonal structures* on a Riemann surface equipped with a nonzero square differential from the various *categories* which are the topic of [Mzk14], Theorem 2.3. We leave the routine details to the interested reader.

COROLLARY 2.7 (Local Linear Holomorphic Structures via Holomorphic Elliptic Cuspidalization). *Let  $\mathbb{X}$  be an elliptically admissible Aut-holomorphic orbispace (cf. Remark 2.1.1) associated to a Riemann orbisurface  $X$ . Then there exists a functorial algorithm for constructing the “local linear holomorphic structure” (cf. Proposition 2.6) on  $\mathbb{X}^{\text{top}}$  that involves only the Aut-holomorphic space  $\mathbb{X}$  as input data, as follows:*

- (a) *By the definition of “elliptically admissible”, we may apply Corollary 2.4, (c), to construct the (Aut-holomorphic orbispace associated to the) semi-elliptic hyperbolic core  $\mathbb{X} \rightarrow \mathbb{H}$  of  $\mathbb{X}$  (i.e.,  $X$ ), together with the unique (cf. [Mzk21], Remark 3.1.1) double covering  $\mathbb{E} \rightarrow \mathbb{H}$  by an Aut-holomorphic space (i.e., the covering determined by the unique torsion-free subgroup of index*

two of the group  $\Pi$  of Corollary 2.4, (c)). (Thus,  $\mathbb{E}$  is the Aut-holomorphic space associated to a once-punctured elliptic curve.)

- (b) By considering “elliptic cuspidalization diagrams” as in [Mzk21], Example 3.2 (cf. also the equivalence of Corollary 2.3, (i))

$$\mathbb{E} \leftarrow \mathbb{U} \rightarrow \mathbb{E}$$

— where  $\mathbb{U} \rightarrow \mathbb{E}$  is an abelian finite étale covering (which necessarily extends to a covering of the one-point compactification of  $\mathbb{E}^{\text{top}}$ );  $\mathbb{E}^{\text{top}} \leftarrow \mathbb{U}^{\text{top}}$  is an open immersion whose image is the complement of a finite subset of  $\mathbb{E}^{\text{top}}$ ;  $\mathbb{E} \leftarrow \mathbb{U}$ ,  $\mathbb{U} \rightarrow \mathbb{E}$  are co-holomorphic — one may construct the torsion points of (the elliptic curve determined by)  $\mathbb{E}$  as the points in the complement of the image of such morphisms  $\mathbb{U} \hookrightarrow \mathbb{E}$ , together with the group structure on these torsion points (which is induced by the group structure of the Galois group  $\text{Gal}(\mathbb{U}/\mathbb{E})$ ).

- (c) Since the torsion points of (b) are dense in  $\mathbb{E}^{\text{top}}$ , one may construct the group structure on (the one-point compactification of)  $\mathbb{E}^{\text{top}}$  (that arises from the elliptic curve determined by  $\mathbb{E}$ ) as the unique topological group structure that extends the group structure on the torsion points of (b). This group structure determines “local additive structures” (cf. Proposition 2.5, (e)) at the various points of  $\mathbb{E}^{\text{top}}$ . Moreover, by considering one-parameter subgroups of these local additive group structures, one constructs the line segments (cf. Proposition 2.5, (a)) of  $\mathbb{E}^{\text{top}}$ ; by considering translations of line segments, relative to these local additive group structures, one constructs the pairs of parallel line segments (cf. Proposition 2.5, (b)) of  $\mathbb{E}^{\text{top}}$ , hence also the parallelograms, frames, and orientations (cf. Proposition 2.5, (c), (d)) of  $\mathbb{E}^{\text{top}}$ .
- (d) Let  $\mathbb{V}$  be the Aut-holomorphic space determined by a parallelogram  $\mathbb{V}^{\text{top}} \subseteq \mathbb{E}^{\text{top}}$  (cf. (c)). Then the one-parameter subgroups of the (topological) group  $\mathcal{A}_{\mathbb{V}}(\mathbb{V}^{\text{top}}) (\cong SL_2(\mathbb{R})/\{\pm 1\}$  — cf. Proposition 2.2, (ii); Corollary 2.3, (i); the Riemann mapping theorem of elementary complex analysis) are precisely the closed connected subgroups for which the complement of some

connected open neighborhood of the identity element fails to be connected. If  $S$  is a one-parameter subgroup of  $\mathcal{A}_{\mathbb{V}}(\mathbb{V}^{\text{top}})$ ,  $p \in \mathbb{V}^{\text{top}}$ , and  $L$  is a line segment one of whose endpoints is equal to  $p$ , then  $L$  is tangent to  $S \cdot p$  at  $p$  if and only if any pairs of sequences of points of  $L \setminus \{p\}$ ,  $(S \cdot p) \setminus \{p\}$ , converge to the same element of the quotient space

$$\mathbb{V}^{\text{top}} \setminus \{p\} \rightarrow \mathbb{P}(\mathbb{V}, p)$$

determined by identifying positive real multiples of elements of  $\mathbb{V}^{\text{top}} \setminus \{p\}$ , relative to the local additive structure at  $p$ . In particular, one may construct the orthogonal frames of  $\mathbb{E}^{\text{top}}$  as the frames consisting of pairs of line segments  $L_1, L_2$  emanating from a point  $p \in \mathbb{E}^{\text{top}}$  that are tangent, respectively, to orbits  $S_1 \cdot p, S_2 \cdot p$  of one-parameter subgroups  $S_1, S_2 \subseteq \mathcal{A}_{\mathbb{V}}(\mathbb{V}^{\text{top}})$  such that  $S_2$  is obtained from  $S_1$  by conjugating  $S_1$  by an element of order four (i.e., “ $\pm i$ ”) of a compact one-parameter subgroup (i.e., a “one-dimensional torus”) of  $\mathcal{A}_{\mathbb{V}}(\mathbb{V}^{\text{top}})$  that fixes  $p$ .

(e) For  $p \in \mathbb{E}^{\text{top}}$ , write

$$\mathcal{A}_p$$

for the group of automorphisms of the projective system of connected open neighborhoods of  $p$  in  $\mathbb{E}^{\text{top}}$  that are compatible with the “local additive structures” of (c) and preserve the orthogonal frames and orientations (at  $p$ ) of (c), (d) (cf. Proposition 2.6, (a)). Then just as in Proposition 2.6, (a), we obtain topological field structures on  $\mathcal{A}_p \cup \{0\}$ , together with compatible isomorphisms  $\mathcal{A}_p \xrightarrow{\sim} \mathcal{A}_{p'}$ , for  $p' \in \mathbb{E}^{\text{top}}$ . This system of “ $\mathcal{A}_p$ ’s” may be thought of as a system of “local linear holomorphic structures” on  $\mathbb{E}^{\text{top}}$  or  $\mathbb{X}^{\text{top}}$ .

Finally, the asserted “functoriality” is with respect to finite étale morphisms of Aut-holomorphic orbispaces arising from hyperbolic orbicurves over  $\mathbb{C}$ .

PROOF. The validity of the algorithm asserted in Corollary 2.7 is immediate from the constructions that appear in the statement of this algorithm (together with the references quoted in these constructions).  $\square$

REMARK 2.7.1. It is by no means the intention of the author to assert that the technique applied in Corollary 2.7, (b), (c), to recover the “local additive structure” via *elliptic cuspidalization* is the *unique* way to construct this *local additive structure*. Indeed, perhaps the most *direct approach* to the problem of constructing the local additive structure is to *compactify* the given once-punctured elliptic curve and then to consider the group structure of the (connected component of the identity of the) *holomorphic automorphism group* of the resulting elliptic curve. By comparison to this direct approach, however, the technique of elliptic cuspidalization has the virtue of being *compatible* with the “*hyperbolic structure*” of the hyperbolic orbicurves involved. In particular, it is compatible with the various “*hyperbolic fundamental groups*” of these orbicurves. This sort of compatibility with fundamental groups plays an essential role in the *nonarchimedean theory* (cf., e.g., the theory of [Mzk18], §1, §2). On the other hand, the “direct approach” described above is not entirely unrelated to the approach via elliptic cuspidalization in the sense that, if one thinks of the *torsion points* in the latter approach as playing an *analogous role* to the role played by the “entire compactified elliptic curve” in the former approach, then the latter approach may be thought of as a sort of *discretization via torsion points* — cf. the point of view of *Hodge-Arakelov theory*, as discussed in [Mzk6], [Mzk7] — of the former approach. Here, we note that the *density of torsion points* in the archimedean theory of the *elliptic cuspidalization* is reminiscent of the *density of NF-points* in the nonarchimedean theory of the *Belyi cuspidalization* (cf. §1).

REMARK 2.7.2. In light of the role played by the technique of *elliptic cuspidalization* both in Corollary 2.7 and in the theory of [Mzk18], §1, §2, it is of interest to compare these two theories. From an archimedean point of view, the theory of [Mzk18] may be roughly summarized as follows: One begins with the *uniformization*

$$G \twoheadrightarrow G/q^{\mathbb{Z}} \xrightarrow{\sim} E$$

of an *elliptic curve*  $E$  over  $\mathbb{C}$  by a copy  $G$  of  $\mathbb{C}^{\times}$ . Here, the “ $q$ -parameter” of  $E$  may be thought of as being an element

$$q \in H \stackrel{\text{def}}{=} G \otimes \text{Gal}(G/E)$$



(where we recall that  $\text{Gal}(G/E) \cong \mathbb{Z}$ ). Then one thinks of the *theta function* associated to  $E$  as a *function*  $\Theta : G \rightarrow H$  (i.e., a function defined on  $G$  with values in  $H$ ). From this point of view, the various types of *rigidity* considered in the theory of [Mzk18] may be understood in the following fashion:

- (a) *Cyclotomic rigidity* corresponds to the portion of the *tautological isomorphism*  $H \xrightarrow{\sim} G \otimes \text{Gal}(G/E)$  involving the *maximal compact subgroups*, i.e., the copies of  $\mathbb{S}^1 \stackrel{\text{def}}{=} \{z \in \mathbb{C}^\times \mid |z| = 1\} \subseteq \mathbb{C}^\times$ .
- (b) *Discrete rigidity* corresponds to the portion of the *tautological isomorphism*  $H \xrightarrow{\sim} G \otimes \text{Gal}(G/E)$  involving the *quotients by the maximal compact subgroups*, i.e., the copies of  $\mathbb{R}_{>0} \stackrel{\text{def}}{=} \{z \in \mathbb{R} \mid z > 0\} \cong \mathbb{C}^\times / \mathbb{S}^1$ .
- (c) *Constant rigidity* corresponds to considering the normalization of  $\Theta$  given by taking the values of  $\Theta$  at the points of  $G$  corresponding to  $\pm\sqrt{-1}$  to be  $\pm 1$ .

In particular, the “*canonical copy of  $\mathbb{C}^\times$* ” that arises from (a), (b) — i.e.,  $H$  — is related to the “copies of  $\mathbb{C}^\times$ ” that occur as the “ $\mathcal{A}_p$ ” of Corollary 2.7, (e), in the following way:  $\mathcal{A}_p$  is given by the linear holomorphic automorphisms of the *tangent space* to a point of  $H$ . That is to say, roughly speaking,  $\mathcal{A}_p (\cong \mathbb{C}^\times)$  is related to  $H (\cong \mathbb{C}^\times)$  by the operation of “*taking the logarithm*”, followed by the operation of “*taking  $\text{Aut}(-)$* ” (of the resulting linearization).

REMARK 2.7.3. It is interesting to note that just as the absolute Galois group  $G_k$  of an MLF  $k$  may be regarded as a *two-dimensional* object with *one rigid* and *one non-rigid* dimension (cf. Remark 1.9.4), the topological group  $\mathbb{C}^\times$  is also a *two-dimensional* object with *one rigid* dimension — i.e.,

$$\mathbb{S}^1 \stackrel{\text{def}}{=} \{z \in \mathbb{C}^\times \mid |z| = 1\} \subseteq \mathbb{C}^\times$$

(a topological group whose automorphism group is of order 2) — and *one non-rigid* dimension — i.e.,

$$\mathbb{R}_{>0} \stackrel{\text{def}}{=} \{z \in \mathbb{R} \mid z > 0\} \subseteq \mathbb{C}^\times$$

(a topological group that is isomorphic to  $\mathbb{R}$ , hence has automorphism group given by  $\mathbb{R}^\times$  — i.e., a “*continuous family of dilations*”). Moreover, just as,

in the context of Theorem 1.9, Corollary 1.10, considering  $G_k$  equipped with its *outer action* on  $\Delta_X$  has the effect of rendering *both dimensions* of  $G_k$  *rigid* (cf. Remark 1.9.4), considering “ $\mathbb{C}^\times$ ” as arising, in the fashion discussed in Corollary 2.7, from a certain *Aut-holomorphic orbispace* has the effect of *rigidifying both dimensions* of  $\mathbb{C}^\times$ . We refer to Remark 2.7.4 below for more on this *analogy* between the

(i) *outer action of  $G_k$  on  $\Delta_X$*

and the notion of an

(ii) *Aut-holomorphic orbispace*

associated to a hyperbolic orbicurve. Finally, we observe that from the point of view of the *problem* of

finding an *algorithm* to construct the *base field* of a hyperbolic orbicurve from (i), (ii),

one may think of Theorem 1.9 and Corollaries 1.10, 2.7 as furnishing *solutions* to various versions of this problem.

REMARK 2.7.4. The usual definition of a “*holomorphic structure*” on a Riemann surface is via *local comparison* to some fixed *model* of the topological field  $\mathbb{C}$ . The local homeomorphisms that enable this comparison are related to one another by homeomorphisms of open neighborhoods of  $\mathbb{C}$  that are holomorphic. On the other hand, this definition does not yield any *absolute* description — i.e., a description that depends on *mathematical structures* that do not involve *explicit use of models* — of what precisely is meant by the notion of a “holomorphic structure”. Instead, it relies on relating/comparing the given manifold to the fixed model of  $\mathbb{C}$  — an approach that is “*model-explicit*”. By contrast, the notion of a *topological space* (i.e., consisting of the datum of a collection of subsets that are to be regarded as “open”) is *absolute*, or “*model-implicit*”. In a similar vein, the approach to *quasi-conformal* or *conformal* structures via the datum of a collection of *parallelograms*, *rectangles*, or *squares* (cf. Propositions 2.5, 2.6; Remark 2.6.1; the theory of [Mzk14]) is “model-implicit”. The approach to “holomorphic structures” on a Riemann surface via the classical notion of a “*conformal structure*” (i.e., the datum of various orthogonal pairs of tangent vectors) is,

so to speak, “*relatively model-implicit*”, i.e., “model-implicit” modulo the fact that it depends on the “*model-explicit*” definition of the notion of a *differential manifold* — which may be thought of as a sort of “local linear structure” that is given by *local comparison* to the local linear structure of Euclidean space. From this point of view:

The notions of an “*outer action of  $G_k$  on  $\Delta_X$* ” and an “*Aut-holomorphic orbispace*” (cf. Remark 2.7.3, (i), (ii)) have the virtue of being “*model-implicit*” — i.e., they do not depend on any sort of (local) comparison to some *fixed reference model*.

In this context, it is interesting to note that all of the examples given so far of “model-implicit” definitions depend on data consisting either of *subsets* (e.g., open subsets of a topological space; parallelograms, rectangles, or squares on a Riemann surface) or *endomorphisms* (e.g., the automorphisms that appear in a Galois category; the automorphisms that appear in an Aut-holomorphic structure). (Here, in passing, we note that the appearance of “endomorphisms” in the present discussion is reminiscent of the discussion of “*hidden endomorphisms*” in the Introduction to [Mzk21].) Also, we observe that this dichotomy between model-explicit and model-implicit definitions is *strongly reminiscent* of the distinction between *bi-anabelian* and *mono-anabelian* geometry discussed in Remark 1.9.8.

Finally, we relate the *archimedean* theory of the present §2 to the *Galois-theoretic* theory of §1, in the case of *number fields*, via a sort of *archimedean analogue* of Corollary 1.10.

COROLLARY 2.8 (Galois-theoretic Reconstruction of Aut-holomorphic Spaces). *Let  $X$ ,  $k \subseteq \bar{k} \supseteq \bar{k}_{\text{NF}}$ , and  $1 \rightarrow \Delta_X \rightarrow \Pi_X \rightarrow G_k \rightarrow 1$  be as in Theorem 1.9; suppose further that  $k$  is a number field (so  $\bar{k}_{\text{NF}} = \bar{k}$ ), and (for simplicity — cf. Remark 2.8.2 below) that  $X$  is a curve. Then one may think of each archimedean prime of the field  $\bar{k}_{\text{NF}}^\times \cup \{0\} (\cong \bar{k}_{\text{NF}})$  constructed in Theorem 1.9, (e), as a topology on  $\bar{k}_{\text{NF}}^\times \cup \{0\}$  satisfying certain properties. Moreover, for each such archimedean prime  $\bar{v}$ , there exists a functorial “group-theoretic” algorithm for reconstructing the Aut-holomorphic space  $\mathbb{X}_{\bar{v}}$  associated to*

$$X_{\bar{v}} \stackrel{\text{def}}{=} X \times_k k_{\bar{v}}$$

(where we write  $k_{\bar{v}}$  for the completion of  $\bar{k}_{\text{NF}}^{\times} \cup \{0\}$  at  $\bar{v}$ ) from the topological group  $\Pi_X$ ; this algorithm consists of the following steps:

- (a) Define a Cauchy sequence  $\{x_j\}_{j \in \mathbb{N}}$  of NF-points (of  $X_{\bar{v}}$ ) to be a sequence of NF-points  $x_j$  (i.e., conjugacy classes of decomposition groups of NF-points in  $\Pi_X$  — cf. Theorem 1.9, (a)) such that there exists a finite set of NF-points  $S$  — which we shall refer to as a conductor for the Cauchy sequence — satisfying the following two conditions: (i)  $x_j \notin S$  for all but finitely many  $j \in \mathbb{N}$ ; (ii) for every NF-rational function  $f$  on  $X_{\bar{k}}$  as in Theorem 1.9, (d), whose divisor of poles avoids  $S$ , the sequence of (non-infinite, for all but finitely many  $j$  — cf. (i)) values  $\{f(x_j) \in k_{\bar{v}}\}_{j \in \mathbb{N}}$  forms a Cauchy sequence (in the usual sense) of  $k_{\bar{v}}$ . Two Cauchy sequences  $\{x_j\}_{j \in \mathbb{N}}$ ,  $\{y_j\}_{j \in \mathbb{N}}$  of NF-points which admit a common conductor  $S$  will be called equivalent if for every NF-rational function  $f$  on  $X_{\bar{k}}$  as in Theorem 1.9, (d), whose divisor of poles avoids  $S$ , the sequences of (non-infinite, for all but finitely many  $j$ ) values  $\{f(x_j)\}_{j \in \mathbb{N}}$ ,  $\{f(y_j)\}_{j \in \mathbb{N}}$  form Cauchy sequences in  $k_{\bar{v}}$  that converge to the same element of  $k_{\bar{v}}$ . For  $U \subseteq k_{\bar{v}}$  an open subset and  $f$  an NF-rational function on  $X_{\bar{k}}$  as in Theorem 1.9, (d), we obtain a set  $N(U, f)$  of Cauchy sequences of NF-points by considering the Cauchy sequences of NF-points  $\{x_j\}_{j \in \mathbb{N}}$  such that  $f(x_j)$  (is finite and)  $\in U$ , for all  $j \in \mathbb{N}$ . Then one constructs the topological space

$$\mathbb{X}^{\text{top}} = X_{\bar{v}}(k_{\bar{v}})$$

as the set of equivalence classes of Cauchy sequences of NF-points, equipped with the topology defined by the sets “ $N(U, f)$ ”.

- (b) Let  $U_{\mathbb{X}} \subseteq \mathbb{X}^{\text{top}}$ ,  $U_{\bar{v}} \subseteq k_{\bar{v}}$  be connected open subsets and  $f$  a NF-rational function on  $X_{\bar{k}}$  as in Theorem 1.9, (d), such that the function defined by  $f$  on  $U_{\mathbb{X}}$  (i.e., by taking limits of Cauchy sequences of values in  $k_{\bar{v}}$  — cf. (a)) determines a homeomorphism  $f_U : U_{\mathbb{X}} \xrightarrow{\sim} U_{\bar{v}}$ . Write  $\text{Aut}^{\text{hol}}(U_{\bar{v}})$  for the group of self-homeomorphisms  $U_{\bar{v}} \xrightarrow{\sim} U_{\bar{v}}$  ( $\subseteq k_{\bar{v}}$ ), which, relative to the topological field structure of  $k_{\bar{v}}$ , can locally (on  $U_{\bar{v}}$ ) be expressed as a convergent power series with coefficients in  $k_{\bar{v}}$ ;  $\mathcal{A}_{\mathbb{X}}(U_{\mathbb{X}}) \stackrel{\text{def}}{=} U_{\bar{v}}$

$f_U^{-1} \circ \text{Aut}^{\text{hol}}(U_{\bar{v}}) \circ f_U \subseteq \text{Aut}(U_{\mathbb{X}})$ . Then one constructs the Aut-holomorphic structure  $\mathcal{A}_{\mathbb{X}}$  on  $\mathbb{X}^{\text{top}}$  as the unique (cf. Corollary 2.3, (ii)) Aut-holomorphic structure that extends the pre-Aut-holomorphic structure determined by the groups “ $\mathcal{A}_{\mathbb{X}}(U_{\mathbb{X}})$ ”; we take  $\mathbb{X}_{\bar{v}}$  to be the Aut-holomorphic space determined by the objects  $(\mathbb{X}^{\text{top}}, \mathcal{A}_{\mathbb{X}})$ .

Finally, the asserted “functoriality” is with respect to arbitrary open injective homomorphisms of profinite groups (i.e., of “ $\Pi_X$ ”) that are compatible with the respective choices of archimedean valuations (i.e., “ $\bar{v}$ ”).

PROOF. The validity of the algorithm asserted in Corollary 2.8 is immediate from the constructions that appear in the statement of this algorithm (together with the references quoted in these constructions).  $\square$

REMARK 2.8.1. One verifies immediately that the isomorphism class of the pair  $(1 \rightarrow \Delta_X \rightarrow \Pi_X \rightarrow G_k \rightarrow 1, \bar{v})$  depends only on the restriction of  $\bar{v}$  to the subfield  $k^{\times} \cup \{0\} \subseteq \bar{k}_{\text{NF}}^{\times} \cup \{0\}$ .

REMARK 2.8.2. One verifies immediately that Corollary 2.8 (as well as Corollary 2.9 below) may be extended to the case where  $X$  is a hyperbolic orbicurve that is not necessarily a curve (so  $\mathbb{X}_{\bar{v}}$  will be an Aut-holomorphic orbispace).

REMARK 2.8.3. One verifies immediately that any elliptically admissible hyperbolic orbicurve defined over a number field is of strictly Belyi type. In particular, if one is given an elliptically admissible hyperbolic orbicurve  $X$  that is defined over a number field  $k$ , then it makes sense to apply Corollary 2.7 to the Aut-holomorphic (orbi)spaces constructed in Corollary 2.8. This compatibility between Corollaries 2.7, 2.8 (cf. also Corollary 2.9 below) is one reason why it is of interest to construct the local additive structures as in Corollary 2.7, (c), directly from the Aut-holomorphic structure as opposed to via the “parallelogram-theoretic” approach of Proposition 2.5, 2.6 (cf. also Remark 2.6.1), which is more suited to “strictly archimedean situations” — i.e., situations in which one is not concerned with regarding Aut-holomorphic orbispaces as arising from hyperbolic orbicurves over number fields.

COROLLARY 2.9 (Global-Archimedean Elliptically Admissible Compatibility). *In the notation of Corollary 2.8, suppose further that  $X$  is elliptically admissible; take the Aut-holomorphic space  $\mathbb{X}$  of Corollary 2.7 to be the Aut-holomorphic space determined by the objects  $(\mathbb{X}^{\text{top}}, \mathcal{A}_{\mathbb{X}})$  constructed in Corollary 2.8. Then one may construct, in a functorially algorithmic fashion, an isomorphism between the topological field  $k_{\bar{v}}$  of Corollary 2.8 and the topological fields “ $\mathcal{A}_p \cup \{0\}$ ” of Corollary 2.7, (e), in the following way:*

- (a) *Let  $x \in X_{\bar{v}}(k_{\bar{v}})$  be an NF-point. The local additive structures on  $\mathbb{E}^{\text{top}}$  (cf. Corollary 2.7, (c)) determine local additive structures on  $\mathbb{X}^{\text{top}}$ ; let  $\vec{v}$  be an element of a sufficiently small neighborhood  $U_{\mathbb{X}} \subseteq \mathbb{X}^{\text{top}}$  of  $x$  in  $\mathbb{X}^{\text{top}}$  that admits such a local additive structure. Then for each NF-rational function  $f$  that vanishes at  $x$ , the assignment*

$$(\vec{v}, f) \mapsto \lim_{n \rightarrow \infty} n \cdot f\left(\frac{1}{n} \cdot_x \vec{v}\right) \in k_{\bar{v}}$$

*(where “ $\cdot_x$ ” is the operation arising from the local additive structure at  $x$ ) depends only on the image  $df|_x \in \omega_x$  of  $f$  in the Zariski cotangent space  $\omega_x$  to  $X_{\bar{v}}$  at  $x$  and, moreover, determines a topological embedding*

$$\iota_{U_{\mathbb{X},x}} : U_{\mathbb{X}} \hookrightarrow \text{Hom}_{k_{\bar{v}}}(\omega_x, k_{\bar{v}})$$

*that is compatible with the “local additive structures” of the domain and codomain.*

- (b) *By letting the neighborhoods  $U_{\mathbb{X}}$  of a fixed NF-point  $x$  vary, the resulting  $\iota_{U_{\mathbb{X},x}}$  determine an isomorphism of topological fields*

$$\mathcal{A}_x \cup \{0\} \xrightarrow{\sim} k_{\bar{v}}$$

*via the condition of compatibility (with respect to the  $\iota_{U_{\mathbb{X},x}}$ ) with the natural actions of  $\mathcal{A}_x$ ,  $k_{\bar{v}}$ , respectively, on the domain and codomain of  $\iota_{U_{\mathbb{X},x}}$ . Moreover, as  $x$  varies, these isomorphisms are compatible with the isomorphisms  $\mathcal{A}_{x_1} \cup \{0\} \xrightarrow{\sim} \mathcal{A}_{x_2} \cup \{0\}$  (where  $x_1, x_2 \in X(k_{\bar{v}})$  are NF-points) of Corollary 2.7, (e).*

Finally, the asserted “functoriality” is to be understood in the sense described in Corollary 2.8.

PROOF. The validity of the algorithm asserted in Corollary 2.9 is immediate from the constructions that appear in the statement of this algorithm (together with the references quoted in these constructions).  $\square$

### Section 3. Nonarchimedean Log-Frobenius Compatibility

In the present §3, we give an interpretation of the *nonarchimedean local portion* of the theory of §1 in terms of a certain *compatibility* with the “log-Frobenius functor” (in essence, a version of the usual “logarithm” at the various nonarchimedean primes of a number field). In order to express this compatibility, certain abstract category-theoretic ideas — which center around the notions of *observables*, *telecores*, and *cores* — are introduced (cf. Definition 3.5). These notions allow one to express the *log-Frobenius compatibility* of the *mono-anabelian* construction algorithms of §1 (cf. Corollary 3.6), as well as the *failure of log-Frobenius compatibility* that occurs if one attempts to take a “bi-anabelian” approach to the situation (cf. Corollary 3.7).

DEFINITION 3.1.

(i) Let  $k$  be an *MLF*,  $\bar{k}$  an *algebraic closure* of  $k$ ,  $G_k \stackrel{\text{def}}{=} \text{Gal}(\bar{k}/k)$ . Write  $\mathcal{O}_k \subseteq k$  for the *ring of integers* of  $k$ ,  $\mathcal{O}_k^\times \subseteq \mathcal{O}_k$  for the *group of units* of  $\mathcal{O}_k$ , and  $\mathcal{O}_k^\times \subseteq \mathcal{O}_k$  for the *multiplicative monoid of nonzero elements* (cf. [Mzk17], Example 1.1, (i)); we shall use similar notation for other subfields of  $\bar{k}$ . Let  $\Pi_k$  be a *topological group*, equipped with a *continuous surjection*  $\epsilon_k : \Pi_k \rightarrow G_k$ . Note that the ( $p$ -adic, if  $k$  is of residue characteristic  $p$ ) *logarithm* determines a  $\Pi_k$ -equivariant isomorphism

$$\log_{\bar{k}} : k^\sim \stackrel{\text{def}}{=} (\mathcal{O}_{\bar{k}}^\times)^{\text{pf}} \xrightarrow{\sim} \bar{k}$$

(where “pf” denotes the *perfection* (cf., e.g., [Mzk16], §0); the  $\Pi_k$ -action is the action obtained by composing with  $\epsilon_k$ ) of the topological group  $k^\sim$  onto the additive topological group  $\bar{k}$ . Next, let us refer to an abelian monoid (e.g., an abelian group) whose subgroup of torsion elements is (abstractly) isomorphic to  $\mathbb{Q}/\mathbb{Z}$  as *torsion-cyclotomic*; let  $\mathbb{T}$  be one of the following categories (cf. §0 for more on the prefix “ind-”):

- $\mathbb{T}\mathbb{F}$ : *ind-topological fields* and homomorphisms of ind-topological fields;
- $\mathbb{T}\mathbb{C}\mathbb{G}$ : *torsion-cyclotomic ind-compact abelian topological groups* and homomorphisms of ind-topological groups;
- $\mathbb{T}\mathbb{L}\mathbb{G}$ : *torsion-cyclotomic ind-locally compact abelian topological groups* and homomorphisms of ind-topological groups;
- $\mathbb{T}\mathbb{M}$ : *torsion-cyclotomic ind-topological abelian monoids* and homomorphisms of ind-topological monoids;
- $\mathbb{T}\mathbb{S}$ : *ind-locally compact topological spaces* and morphisms of ind-topological spaces;
- $\mathbb{T}\mathbb{S}\mathbb{H}$ : *ind-locally compact abelian topological groups* and homomorphisms of ind-topological groups (so we have a natural full embedding  $\mathbb{T}\mathbb{L}\mathbb{G} \hookrightarrow \mathbb{T}\mathbb{S}\mathbb{H}$ ).

If  $\mathbb{T}$  is equal to  $\mathbb{T}\mathbb{F}$  (respectively,  $\mathbb{T}\mathbb{C}\mathbb{G}$ ;  $\mathbb{T}\mathbb{L}\mathbb{G}$ ;  $\mathbb{T}\mathbb{M}$ ;  $\mathbb{T}\mathbb{S}$ ;  $\mathbb{T}\mathbb{S}\mathbb{H}$ ), then let  $M_{\bar{k}} \in \text{Ob}(\mathbb{T})$  be the object determined by  $\bar{k}$  (respectively, the object determined by  $\mathcal{O}_{\bar{k}}^{\times}$ ; the object determined by  $\bar{k}^{\times}$ ; the object determined by  $\mathcal{O}_{\bar{k}}^{\geq}$ ; any object of  $\mathbb{T}\mathbb{S}$  equipped with a *faithful* continuous  $G_k$ -action; any object of  $\mathbb{T}\mathbb{S}\mathbb{H}$  equipped with a *faithful* continuous  $G_k$ -action). We shall refer to as a *model MLF-Galois  $\mathbb{T}$ -pair* any collection of data (a), (b), (c) of the following form:

- (a) the *topological group*  $\Pi_k$ ,
- (b) the *object*  $M_{\bar{k}} \in \text{Ob}(\mathbb{T})$ ,
- (c) the *action* of  $\Pi_k$  on  $M_{\bar{k}}$

(so the quotient  $\Pi_k \twoheadrightarrow G_k$  may be recovered as the image of the homomorphism  $\Pi_k \rightarrow \text{Aut}(M_{\bar{k}})$  arising from the action of (c)); we shall often use the abbreviated notation  $(\Pi_k \curvearrowright M_{\bar{k}})$  for this collection of data (a), (b), (c).

(ii) We shall refer to any collection of data  $(\Pi \curvearrowright M)$  consisting of a topological group  $\Pi$ , an object  $M \in \text{Ob}(\mathbb{T})$ , and a continuous action of  $\Pi$  on  $M$  as an *MLF-Galois  $\mathbb{T}$ -pair* if, for some model MLF-Galois  $\mathbb{T}$ -pair  $(\Pi_k \curvearrowright M_{\bar{k}})$  (where the notation is as in (i)), there exist an isomorphism of topological groups  $\Pi_k \xrightarrow{\sim} \Pi$  and an isomorphism of objects  $M_{\bar{k}} \xrightarrow{\sim} M$  of  $\mathbb{T}$  that are compatible with the respective actions of  $\Pi_k$ ,  $\Pi$  on  $M_{\bar{k}}$ ,  $M$ ; in this



situation, we shall refer to  $\Pi$  as the *Galois group*, to the surjection  $\Pi \twoheadrightarrow G$  determined by the action of  $\Pi$  on  $M$  (cf. (i)) as the *Galois augmentation*, to  $G$  as the *arithmetic Galois group*, and to  $M$  as the *arithmetic data* of the MLF-Galois  $\mathbb{T}$ -pair  $(\Pi \curvearrowright M)$ ; if, in this situation, the surjection  $\Pi_k \twoheadrightarrow G_k$  arises from the étale fundamental group of an arbitrary hyperbolic orbicurve (respectively, a hyperbolic orbicurve of strictly Belyi type) over  $k$ , then we shall refer to the MLF-Galois  $\mathbb{T}$ -pair  $(\Pi \curvearrowright M)$  as being *of hyperbolic orbicurve type* (respectively, *of strictly Belyi type*); if, in this situation, the surjection  $\Pi_k \twoheadrightarrow G_k$  is an *isomorphism*, then we shall refer to the MLF-Galois  $\mathbb{T}$ -pair  $(\Pi \curvearrowright M)$  as being *of mono-analytic type* (cf. Remark 5.6.1 below for more on this terminology). A *morphism of MLF-Galois  $\mathbb{T}$ -pairs*

$$\phi : (\Pi_1 \curvearrowright M_1) \rightarrow (\Pi_2 \curvearrowright M_2)$$

consists of a *morphism* of objects  $\phi_M : M_1 \rightarrow M_2$  of  $\mathbb{T}$ , together with a *compatible* (relative to the respective actions of  $\Pi_1, \Pi_2$  on  $M_1, M_2$ ) *continuous homomorphism* of topological groups  $\phi_\Pi : \Pi_1 \rightarrow \Pi_2$  that induces an *open injective* homomorphism between the respective *arithmetic Galois groups*; if, in this situation,  $\phi_M$  (respectively,  $\phi_\Pi$ ) is an isomorphism, then we shall refer to  $\phi$  as a  $\mathbb{T}$ -*isomorphism* (respectively, *Galois-isomorphism*).

(iii) Write

$$\mathcal{C}_{\mathbb{T}}^{\text{MLF}}$$

for the *category* whose *objects* are the *MLF-Galois  $\mathbb{T}$ -pairs* and whose *morphisms* are the *morphisms of MLF-Galois  $\mathbb{T}$ -pairs*. Also, we shall use the same notation, except with “ $\mathcal{C}$ ” replaced by

$$\underline{\mathcal{C}} \text{ (respectively, } \overline{\mathcal{C}}; \underline{\underline{\mathcal{C}}})$$

to denote the various subcategories determined by the  $\mathbb{T}$ -*isomorphisms* (respectively, *Galois-isomorphisms*; *isomorphisms*); we shall use the same notation, with “MLF” replaced by

$$\text{MLF-hyp (respectively, MLF-sB; MLF}\vdash)$$

to denote the various full subcategories determined by the objects of *hyperbolic orbicurve type* (respectively, *of strictly Belyi type*; *of mono-analytic type*). Since (in the notation of (i)) the formation of  $\mathcal{O}_k^{\triangleright}$  (respectively,  $\overline{k}^{\times}$ ;

$\mathcal{O}_{\bar{k}}^{\times}; \mathcal{O}_{\bar{k}}^{\times}$ ) from  $\bar{k}$  (respectively,  $\mathcal{O}_{\bar{k}}^{\geq}; \mathcal{O}_{\bar{k}}^{\geq}; \bar{k}^{\times}$ ) is clearly *intrinsically defined* (i.e., depends only on the “input data of an object of  $\mathbb{T}$ ”), we thus obtain *natural functors*

$$\mathcal{C}_{\mathbb{TF}}^{\text{MLF}} \rightarrow \mathcal{C}_{\mathbb{TM}}^{\text{MLF}}; \quad \mathcal{C}_{\mathbb{TM}}^{\text{MLF}} \rightarrow \mathcal{C}_{\mathbb{TLG}}^{\text{MLF}}; \quad \mathcal{C}_{\mathbb{TM}}^{\text{MLF}} \rightarrow \mathcal{C}_{\mathbb{TCG}}^{\text{MLF}}; \quad \mathcal{C}_{\mathbb{TLG}}^{\text{MLF}} \rightarrow \mathcal{C}_{\mathbb{TCG}}^{\text{MLF}}$$

— i.e., by taking the *multiplicative group* of nonzero integral elements (i.e., the elements  $a \in k^{\times}$  such that  $a^{-n}$  fails to converge to 0, as  $\mathbb{N} \ni n \rightarrow +\infty$ ) of the arithmetic data, the associated *groupification*  $M^{\text{gp}}$  of the arithmetic data  $M$ , the *subgroup of invertible elements*  $M^{\times}$  of the arithmetic data  $M$ , or the *maximal compact subgroups* of the subgroups of the arithmetic data obtained as subgroups of invariants for various open subgroups of the Galois group. Finally, we shall write

$$\mathbb{TG}$$

for the *category of topological groups* and continuous homomorphisms and

$$\mathbb{TG} \supseteq \mathbb{TG}^{\text{hyp}} \supseteq \mathbb{TG}^{\text{sB}}$$

for the subcategories determined, respectively, by the étale fundamental groups of arbitrary hyperbolic orbicurves over MLF’s and the étale fundamental groups of hyperbolic orbicurves of strictly Belyi type over MLF’s, and the homomorphisms that induce open injections on the quotients constituted by the absolute Galois groups of the base field MLF’s; also, we shall use the same notation, except with “ $\mathbb{TG}$ ” replaced by  $\underline{\mathbb{TG}}$  to denote the various subcategories determined by the *isomorphisms*. Thus, for  $\mathbb{T} \in \{\mathbb{TF}, \mathbb{TCG}, \mathbb{TLG}, \mathbb{TM}, \mathbb{TS}, \mathbb{TS\boxplus}\}$ , the assignment  $(\Pi \curvearrowright M) \mapsto \Pi$  determines various *compatible natural functors*

$$\mathcal{C}_{\mathbb{T}}^{\text{MLF}} \rightarrow \mathbb{TG}$$

(as well as *double underlined* versions of these functors).

(iv) Observe that (in the notation of (i)) the field structure of  $\bar{k}$  determines, via the inverse morphism to  $\log_{\bar{k}}$ , a structure of *topological field* on the topological group  $k^{\sim}$ . Since the various operations applied here to construct this field structure on  $k^{\sim}$  (such as, for instance, the *power series* used to define  $\log_{\bar{k}}$ ) are clearly *intrinsically defined* (cf. the natural functors defined in (iii)), we thus obtain that the construction that assigns

$$\begin{aligned} & \text{(the ind-topological field } \bar{k}, \text{ with its natural } \Pi_k\text{-action)} \\ & \mapsto \text{(the ind-topological field } k^{\sim}, \text{ with its natural } \Pi_k\text{-action)} \end{aligned}$$

determines a *natural functor*

$$\mathbf{log}_{\mathbb{T}\mathbb{F},\mathbb{T}\mathbb{F}} : \mathcal{C}_{\mathbb{T}\mathbb{F}}^{\text{MLF}} \rightarrow \mathcal{C}_{\mathbb{T}\mathbb{F}}^{\text{MLF}}$$

— which we shall refer to as the *log-Frobenius functor* (cf. Remark 3.6.2 below). Since  $\mathbf{log}_{\bar{k}}$  determines a *functorial isomorphism* between the fields  $\bar{k}$ ,  $k^\sim$ , it follows immediately that the functor  $\mathbf{log}_{\mathbb{T}\mathbb{F},\mathbb{T}\mathbb{F}}$  is *isomorphic to the identity functor* (hence, in particular, is an *equivalence of categories*). By composing  $\mathbf{log}_{\mathbb{T}\mathbb{F},\mathbb{T}\mathbb{F}}$  with the various natural functors defined in (iii), we also obtain, for  $\mathbb{T} \in \{\mathbb{T}\mathbb{L}\mathbb{G}, \mathbb{T}\mathbb{C}\mathbb{G}, \mathbb{T}\mathbb{M}\}$ , a functor

$$\mathbf{log}_{\mathbb{T}\mathbb{F},\mathbb{T}} : \mathcal{C}_{\mathbb{T}\mathbb{F}}^{\text{MLF}} \rightarrow \mathcal{C}_{\mathbb{T}}^{\text{MLF}}$$

— which (by abuse of terminology) we shall also refer to as “*the log-Frobenius functor*”. In a similar vein, the assignments

- (the ind-topological field  $\bar{k}$ , with its natural  $\Pi_k$ -action)
- $\mapsto$  (the ind-topological space  $\bar{k}^\times$ , with its natural  $\Pi_k$ -action)
- (the ind-topological field  $\bar{k}$ , with its natural  $\Pi_k$ -action)
- $\mapsto$  (the ind-topological space  $(\bar{k}^\times)^{\text{pf}}$ , with its natural  $\Pi_k$ -action)

determine *natural functors*

$$\lambda^\times : \mathcal{C}_{\mathbb{T}\mathbb{F}}^{\text{MLF}} \rightarrow \mathcal{C}_{\mathbb{T}\mathbb{S}}^{\text{MLF}}; \quad \lambda^{\times\text{pf}} : \mathcal{C}_{\mathbb{T}\mathbb{F}}^{\text{MLF}} \rightarrow \mathcal{C}_{\mathbb{T}\mathbb{S}}^{\text{MLF}}$$

together with *diagrams of functors*

$$\begin{array}{ccc} \mathcal{C}_{\mathbb{T}\mathbb{F}}^{\text{MLF}} & \xrightarrow{\mathbf{log}_{\mathbb{T}\mathbb{F},\mathbb{T}\mathbb{F}}} & \mathcal{C}_{\mathbb{T}\mathbb{F}}^{\text{MLF}} & & \mathcal{C}_{\mathbb{T}\mathbb{F}}^{\text{MLF}} \\ \downarrow \lambda^{\times\text{pf}} & \wr \iota_{\mathbf{log}} & \downarrow \lambda^\times & & \lambda^\times \downarrow \wr \iota_\times \downarrow \lambda^{\times\text{pf}} \\ \mathcal{C}_{\mathbb{T}\mathbb{S}}^{\text{MLF}} & = & \mathcal{C}_{\mathbb{T}\mathbb{S}}^{\text{MLF}} & & \mathcal{C}_{\mathbb{T}\mathbb{S}}^{\text{MLF}} \end{array}$$

— where we write  $\iota_{\mathbf{log}} : \lambda^\times \circ \mathbf{log}_{\mathbb{T}\mathbb{F},\mathbb{T}\mathbb{F}} \rightarrow \lambda^{\times\text{pf}}$  for the natural transformation induced by the natural inclusion “ $(k^\sim)^\times \hookrightarrow k^\sim = (\mathcal{O}_{\bar{k}}^\times)^{\text{pf}} \hookrightarrow (\bar{k}^\times)^{\text{pf}}$ ” and  $\iota_\times : \lambda^\times \rightarrow \lambda^{\times\text{pf}}$  for the natural transformation induced by the natural map “ $\bar{k}^\times \rightarrow (\bar{k}^\times)^{\text{pf}}$ ”. Finally, we note that the subfield of Galois-invariants “ $(k^\sim)^{\Pi_k}$ ” of the field “ $k^\sim$ ” obtained by the above construction (i.e., the arithmetic data of an object in the image of the log-Frobenius

functor  $\mathbf{log}_{\mathbb{T}\mathbb{F}, \mathbb{T}\mathbb{F}}$  is equipped with a *natural “compactum”* — i.e., the compact submodule of  $k^\sim = (\mathcal{O}_k^\times)^{\text{Pf}}$  determined by the *image of the subgroup*  $\mathcal{O}_k^\times = (\mathcal{O}_{\bar{k}}^\times)^{\Pi_k} \subseteq \mathcal{O}_{\bar{k}}^\times$  of Galois-invariants of  $\mathcal{O}_{\bar{k}}^\times$  — which we shall refer to as the *pre-log-shell*

$$\lambda_{(\Pi \curvearrowright M)} \subseteq \mathbf{log}_{\mathbb{T}\mathbb{F}, \mathbb{T}\mathbb{F}}^{\text{arith}}((\Pi \curvearrowright M))$$

(where  $(\Pi \curvearrowright M) \in \text{Ob}(\mathcal{C}_{\mathbb{T}\mathbb{F}}^{\text{MLF}})$ ) of the arithmetic data  $\mathbf{log}_{\mathbb{T}\mathbb{F}, \mathbb{T}\mathbb{F}}^{\text{arith}}((\Pi \curvearrowright M))$  of the object determined by applying the log-Frobenius functor  $\mathbf{log}_{\mathbb{T}\mathbb{F}, \mathbb{T}\mathbb{F}}$  to the object  $(\Pi \overset{\kappa}{\curvearrowright} M)$ .

(v) In the notation of (i), suppose further that  $\mathbb{T} \in \{\text{TLG}, \text{TCG}, \text{TM}\}$ ; let  $(\Pi \curvearrowright M)$  be an *MLF-Galois  $\mathbb{T}$ -pair*. Then we shall refer to the profinite  $\Pi$ -module

$$\mu_{\widehat{\mathbb{Z}}}(M) \stackrel{\text{def}}{=} \text{Hom}(\mathbb{Q}/\mathbb{Z}, M)$$

(which is isomorphic to  $\widehat{\mathbb{Z}}$ ) as the *cyclotome* associated to  $(\Pi \curvearrowright M)$ . Also, we shall write  $\mu_{\mathbb{Q}/\mathbb{Z}}(M) \stackrel{\text{def}}{=} \mu_{\widehat{\mathbb{Z}}}(M) \otimes \mathbb{Q}/\mathbb{Z}$ .

(vi) Recall the “image via the Kummer map of the multiplicative group of an algebraic closure of the base field”

$$\bar{k}^\times \hookrightarrow \varinjlim_J H^1(J, \mu_{\widehat{\mathbb{Z}}}(\Pi))$$

(where “ $J$ ” ranges over the open subgroups of  $\Pi$ ) — which was constructed via a purely “*group-theoretic*” *algorithm* in Corollary 1.10, (d), (h), for  $\Pi \in \text{Ob}(\mathbb{T}\mathbb{G}^{\text{sB}})$ . Write

$$\mathfrak{Anab}$$

for the category whose *objects* are pairs

$$\left( \Pi, \Pi \curvearrowright \left\{ \bar{k}^\times \hookrightarrow \varinjlim_J H^1(J, \mu_{\widehat{\mathbb{Z}}}(\Pi)) \right\} \right)$$

consisting of an object  $\Pi \in \text{Ob}(\mathbb{T}\mathbb{G}^{\text{sB}})$ , together with the image of the Kummer map reviewed above, equipped with its topological field structure and natural action via  $\Pi$  — all of which is to be understood as constructed via the “*group-theoretic*” *algorithms* of Corollary 1.10, (d), (h) (cf. Remark 3.1.2 below) — and whose *morphisms* are the morphisms induced by isomorphisms of  $\mathbb{T}\mathbb{G}^{\text{sB}}$ . Thus, we obtain a *natural functor*

$$\mathbb{T}\mathbb{G}^{\text{sB}} \xrightarrow{\kappa_{\mathfrak{An}}} \mathfrak{Anab}$$

which (as is easily verified) is an *equivalence of categories*, a quasi-inverse for which is given by the natural projection functor  $\mathfrak{Anab} \rightarrow \underline{\mathbb{TG}}^{\text{SB}}$ .

REMARK 3.1.1. Observe that (in the notation of Definition 3.1, (i)) the *topology* on the field  $k$ , the groups  $k^\times$  and  $\mathcal{O}_k^\times$ , or the monoid  $\mathcal{O}_k^\triangleright$  is *completely determined* by the field, group, or monoid structures of these objects. Indeed, the topology on  $\mathcal{O}_k^\times$  is precisely the *profinite topology*; the topologies on  $k$ ,  $k^\times$ , and  $\mathcal{O}_k^\triangleright$  are determined by the topology on the subset  $\mathcal{O}_k^\times \subseteq \mathcal{O}_k^\triangleright \subseteq k^\times \subseteq k$  (cf. the various natural functors of Definition 3.1, (iii); the fact that  $\mathcal{O}_k^\times \subseteq k^\times$  may be characterized as the subgroup of elements divisible by arbitrary powers of some prime number). Suppose that  $\mathbb{T} \neq \mathbb{TS}, \mathbb{TS}\boxplus$ . Then note that one may apply this observation to the various subfields, subgroups, or submonoids obtained from the arithmetic data of an MLF-Galois  $\mathbb{T}$ -pair by taking the invariants with respect to some open subgroup of the Galois group. Thus, we conclude that one obtains an entirely equivalent theory if one *omits the specification of the topology*, as well as of the “*ind-*” *structure* (i.e., one works with the inductive *limit* fields, groups, or monoids, as opposed to the inductive *systems* of such objects) from the objects of  $\mathbb{T}$  considered in Definition 3.1, (i). In particular, the data that forms an object of  $\mathcal{C}_{\mathbb{TM}}^{\text{MLF}}$  is *precisely* the data used to construct the “*model  $p$ -adic Frobenioids*” of [Mzk17], Example 1.1.

REMARK 3.1.2. It is important to note that, by definition, the *algorithms* of Corollary 1.10 form an *essential portion of each object* of the category  $\mathfrak{Anab}$ . Put another way, the “*software*” constituted by these algorithms is *not just executed once*, leaving behind some “output data” that suffices for the remainder of the development of the theory, but rather *executed over and over again* within each object of  $\mathfrak{Anab}$ .

REMARK 3.1.3. One natural variant of the notion of an “MLF-Galois  $\mathbb{T}$ -pair of hyperbolic orbicurve type” is the notion of an “*MLF-Galois  $\mathbb{T}$ -pair of tempered hyperbolic orbicurve type*”, i.e., the case where (in the notation of Definition 3.1, (ii))  $\Pi_k \twoheadrightarrow G_k$  arises from the *tempered fundamental group* of a hyperbolic orbicurve over  $k$  (cf. Remarks 1.9.1, 1.10.2). We leave to the reader the routine details of developing the resulting tempered version of the theory to follow.

PROPOSITION 3.2 (Monoid Cyclotomes and Kummer Maps). *Let  $\mathbb{T} \in$*

$\{\mathbb{T}\mathbb{M}, \mathbb{T}\mathbb{F}\}$ ;  $(\Pi \curvearrowright M_{\mathbb{T}}) \in \text{Ob}(\mathcal{C}_{\mathbb{T}}^{\text{MLF}})$  an MLF-Galois  $\mathbb{T}$ -pair, with arithmetic Galois group  $\Pi \twoheadrightarrow G$ . Write  $(\Pi \curvearrowright M_{\mathbb{T}\mathbb{M}}) \in \text{Ob}(\mathcal{C}_{\mathbb{T}\mathbb{M}}^{\text{MLF}})$  for the object obtained from  $(\Pi \curvearrowright M_{\mathbb{T}})$  by applying the identity functor if  $\mathbb{T} = \mathbb{T}\mathbb{M}$  or by applying the natural functor of Definition 3.1, (iii), if  $\mathbb{T} = \mathbb{T}\mathbb{F}$ . Then:

(i) The arguments given in the proof of [Mzk9], Proposition 1.2.1, (vii), yield a functorial (i.e., relative to  $\mathcal{C}_{\mathbb{T}}^{\text{MLF}}$ , in the evident sense — cf. Remark 3.2.2 below) algorithm for constructing the natural isomorphism

$$H^2(G, \mu_{\mathbb{Z}}(M_{\mathbb{T}\mathbb{M}})) \xrightarrow{\sim} \widehat{\mathbb{Z}}$$

— i.e., by composing the natural isomorphism (of “Brauer groups”)

$$H^2(G, \mu_{\mathbb{Q}/\mathbb{Z}}(M_{\mathbb{T}\mathbb{M}})) \xrightarrow{\sim} H^2(G, M_{\mathbb{T}\mathbb{M}}^{\text{gp}})$$

(where “gp” denotes the groupification of a monoid) with the inverse of the natural isomorphism (of “Brauer groups”)

$$H^2(G^{\text{unr}}, (M_{\mathbb{T}\mathbb{M}}^{\text{unr}})^{\text{gp}}) \xrightarrow{\sim} H^2(G, M_{\mathbb{T}\mathbb{M}}^{\text{gp}})$$

(where  $M_{\mathbb{T}\mathbb{M}}^{\text{unr}} \subseteq M_{\mathbb{T}\mathbb{M}}$  denotes the submonoid of elements fixed by the kernel of the quotient  $G \twoheadrightarrow G^{\text{unr}}$  of Corollary 1.10, (b)) followed by the natural composite isomorphism

$$H^2(G^{\text{unr}}, (M_{\mathbb{T}\mathbb{M}}^{\text{unr}})^{\text{gp}}) \xrightarrow{\sim} H^2(G^{\text{unr}}, (M_{\mathbb{T}\mathbb{M}}^{\text{unr}})^{\text{gp}} / (M_{\mathbb{T}\mathbb{M}}^{\text{unr}})^{\times}) \xrightarrow{\sim} H^2(\widehat{\mathbb{Z}}, \mathbb{Z}) \xrightarrow{\sim} \mathbb{Q}/\mathbb{Z}$$

(where “ $\times$ ” denotes the subgroup of invertible elements of a monoid; the isomorphism  $(M_{\mathbb{T}\mathbb{M}}^{\text{unr}})^{\text{gp}} / (M_{\mathbb{T}\mathbb{M}}^{\text{unr}})^{\times} \xrightarrow{\sim} \mathbb{Z}$  is obtained by considering a generator of the monoid  $M_{\mathbb{T}\mathbb{M}}^{\text{unr}} / (M_{\mathbb{T}\mathbb{M}}^{\text{unr}})^{\times} \cong \mathbb{N}$ ; we apply the isomorphism  $G^{\text{unr}} \xrightarrow{\sim} \widehat{\mathbb{Z}}$  of Corollary 1.10, (b)) and then applying the functor  $\text{Hom}(\mathbb{Q}/\mathbb{Z}, -)$  to the resulting isomorphism  $H^2(G, \mu_{\mathbb{Q}/\mathbb{Z}}(M_{\mathbb{T}\mathbb{M}})) \xrightarrow{\sim} \mathbb{Q}/\mathbb{Z}$  (cf. also Remark 3.2.1 below).

(ii) By considering the action of open subgroups  $H \subseteq \Pi$  on elements of  $M_{\mathbb{T}\mathbb{M}}$  that are roots of elements of  $M_{\mathbb{T}\mathbb{M}}^H$  (i.e., the submonoid of  $M_{\mathbb{T}\mathbb{M}}$  consisting of  $H$ -invariant elements), we obtain a functorial (i.e., relative to  $\mathcal{C}_{\mathbb{T}}^{\text{MLF}}$ , in the evident sense) algorithm for constructing the Kummer maps

$$M_{\mathbb{T}\mathbb{M}}^H \rightarrow H^1(H, \mu_{\mathbb{Z}}(M_{\mathbb{T}\mathbb{M}})); \quad M_{\mathbb{T}\mathbb{M}} \rightarrow \varinjlim_J H^1(J, \mu_{\mathbb{Z}}(M_{\mathbb{T}\mathbb{M}}))$$

— where “ $J$ ” ranges over the open subgroups of  $\Pi$ . In particular, the “ $\mu_{\mathbb{Z}}(M_{\mathbb{T}\mathbb{M}})$ ” in the above display may be replaced by “ $\mu_{\mathbb{Z}}(G)$ ” (cf. Remarks 3.2.1, 3.2.2 below); if, moreover,  $(\Pi \curvearrowright M_{\mathbb{T}})$  is of hyperbolic orbicurve type, then the “ $\mu_{\mathbb{Z}}(M_{\mathbb{T}\mathbb{M}})$ ” in the above display may be replaced by “ $\mu_{\mathbb{Z}}(\Pi)$ ” (cf. Corollary 1.10, (c)) or “ $\mu_{\mathbb{Z}}^k(\Pi)$ ” (cf. Remark 1.10.3, (ii)) — cf. Remark 3.2.2 below.

(iii) Suppose that  $(\Pi \curvearrowright M_{\mathbb{T}})$  is of strictly Belyi type. Then the construction of Corollary 1.10, (h), determines an additive structure (hence, in particular, a topological field structure) on the union with “ $\{0\}$ ” of the group generated by the image of the Kummer map

$$M_{\mathbb{T}\mathbb{M}} \rightarrow \varinjlim_J H^1(J, \mu_{\mathbb{Z}}(M_{\mathbb{T}\mathbb{M}}))$$

of (ii). In particular, these constructions yield a functorial (i.e., relative to  $\underline{\mathcal{C}}_{\mathbb{T}}^{\text{MLF}}$ , in the evident sense — cf. Remark 3.2.2 below) algorithm for constructing this topological field structure.

(iv) If  $(\Pi^* \curvearrowright M_{\mathbb{T}}^*) \in \text{Ob}(\underline{\mathcal{C}}_{\mathbb{T}}^{\text{MLF}})$ , then the natural functor of Definition 3.1, (iii), induces an injection

$$\text{Isom}_{\underline{\mathcal{C}}_{\mathbb{T}}^{\text{MLF}}}((\Pi \curvearrowright M_{\mathbb{T}}), (\Pi^* \curvearrowright M_{\mathbb{T}}^*)) \hookrightarrow \text{Isom}_{\text{T}\mathbb{G}}(\Pi, \Pi^*)$$

on sets of isomorphisms; this injection is a bijection if  $\mathbb{T} = \mathbb{T}\mathbb{M}$ , or if ( $\mathbb{T}$  is either  $\mathbb{T}\mathbb{M}$  or  $\mathbb{T}\mathbb{F}$ , and)  $(\Pi \curvearrowright M_{\mathbb{T}})$ ,  $(\Pi^* \curvearrowright M_{\mathbb{T}}^*)$  are of strictly Belyi type. In particular, if  $(\Pi \curvearrowright M_{\mathbb{T}})$  is of hyperbolic orbicurve type, then the group

$$\text{Aut}_{\underline{\mathcal{C}}_{\mathbb{T}}^{\text{MLF}}}((\Pi \curvearrowright M_{\mathbb{T}}))$$

— which is isomorphic to a subgroup of  $\text{Aut}_{\text{T}\mathbb{G}}(\Pi)$  that contains the subgroup of  $\text{Aut}_{\text{T}\mathbb{G}}(\Pi)$  determined by the inner automorphisms of  $\Pi$  — is center-free; the categories  $\text{T}\mathbb{G}^{\text{hyp}}$ ,  $\text{T}\mathbb{G}^{\text{sB}}$ ,  $\underline{\text{T}\mathbb{G}}^{\text{hyp}}$ ,  $\underline{\text{T}\mathbb{G}}^{\text{sB}}$ ,  $\underline{\mathcal{C}}_{\mathbb{T}}^{\text{MLF-hyp}}$ ,  $\underline{\mathcal{C}}_{\mathbb{T}}^{\text{MLF-sB}}$ ,  $\underline{\mathcal{C}}_{\mathbb{T}}^{\text{MLF-hyp}}$ ,  $\underline{\underline{\mathcal{C}}}_{\mathbb{T}}^{\text{MLF-sB}}$  are id-rigid (cf. §0).

(v) The algorithm of (iii) yields a natural (1-)factorization

$$\mathcal{C}_{\mathbb{T}\mathbb{F}}^{\text{MLF-sB}} \longrightarrow \mathcal{C}_{\mathbb{T}}^{\text{MLF-sB}} \xrightarrow{\log_{\mathbb{T}, \mathbb{T}'}} \mathcal{C}_{\mathbb{T}'}^{\text{MLF-sB}}$$

— where  $\mathbb{T}' \in \{\mathbb{T}\mathbb{F}, \text{TL}\mathbb{G}, \text{T}\mathbb{C}\mathbb{G}, \mathbb{T}\mathbb{M}\}$ ; the first arrow is the natural functor of Definition 3.1, (iii), if  $\mathbb{T} = \mathbb{T}\mathbb{M}$ , or the identity functor if  $\mathbb{T} = \mathbb{T}\mathbb{F}$  — of

the (“sB” versions of the) log-Frobenius functors  $\mathbf{log}_{\mathbb{T}\mathbb{F}, \mathbb{T}} : \mathcal{C}_{\mathbb{T}\mathbb{F}}^{\text{MLF}} \rightarrow \mathcal{C}_{\mathbb{T}}^{\text{MLF}}$  of Definition 3.1, (iv). Moreover, the functor  $\mathbf{log}_{\mathbb{T}, \mathbb{T}}$  is isomorphic to the identity functor (hence, in particular, is an equivalence of categories).

PROOF. Assertions (i), (ii), (iii), (v) are immediate from the constructions that appear in the statement of these assertions (together with the references quoted in these constructions). The *injectivity portion* of assertion (iv) follows from the functorial algorithms of assertions (i), (ii) (which imply that automorphisms of  $(\Pi \curvearrowright M_{\mathbb{T}\mathbb{M}})$  that act trivially on  $\Pi$  necessarily act trivially on  $M_{\mathbb{T}\mathbb{M}}$ ). In light of this injectivity, the *center-free-ness portion* of assertion (iv) follows immediately from the *slimness* of  $\Pi$  (cf., e.g., [Mzk20], Proposition 2.3, (ii)). The *surjectivity portion* of assertion (iv) follows from assertion (iii), when  $(\Pi \curvearrowright M_{\mathbb{T}})$ ,  $(\Pi^* \curvearrowright M_{\mathbb{T}}^*)$  are of *strictly Belyi type*, and from considering the “copy of  $M_{\mathbb{T}\mathbb{M}} \xrightarrow{\sim} \mathcal{O}_k^{\times}$  embedded in abelianizations of open subgroups of  $G \xrightarrow{\sim} G_k$  via *local class field theory*” (cf., e.g., [Mzk9], Proposition 1.2.1, (iii), (iv)), together with assertions (i), (ii) (cf. also the first displayed isomorphism of Corollary 1.10, (b)), when  $\mathbb{T} = \mathbb{T}\mathbb{M}$ .  $\square$

REMARK 3.2.1. Note that the algorithm applied to construct the natural isomorphism of Corollary 1.10, (a), is essentially the *same* as the algorithm of Proposition 3.2, (i). In particular, this algorithm does *not* require that  $(\Pi \curvearrowright M_{\mathbb{T}})$  be of *hyperbolic orbicurve type*. Thus, by imposing the condition of “*compatibility with the natural isomorphism of Corollary 1.10, (a)*”, we thus obtain, in the context of Proposition 3.2, (i), a *functorial algorithm* for constructing the *natural isomorphism*

$$\mu_{\widehat{\mathbb{Z}}}(M_{\mathbb{T}\mathbb{M}}) \xrightarrow{\sim} \mu_{\widehat{\mathbb{Z}}}(G)$$

(cf. also Remark 1.10.3, (ii)).

REMARK 3.2.2. Note that (cf. Remark 1.10.1, (iii)) the *functoriality* of Proposition 3.2, (i), when applied to the isomorphism  $H^2(G, \mu_{\widehat{\mathbb{Z}}}(M_{\mathbb{T}\mathbb{M}})) \xrightarrow{\sim} \widehat{\mathbb{Z}}$ , is to be understood in the sense of a “*compatibility*”, relative to *dividing* the “ $\widehat{\mathbb{Z}}$ ” that appears as the codomain of these isomorphisms by a *factor* given by the *index* of the image of the induced open homomorphism on arithmetic Galois groups (cf. Definition 3.1, (ii)). A similar remark (cf. Remark



1.10.1, (i)) applies to the cyclotome “ $\mu_{\widehat{\mathbb{Z}}}(\Pi)$ ” that appears in Proposition 3.2, (ii). We leave the routine details to the reader.

In a similar vein, one may consider *Kummer maps* for “ $\mathcal{O}^\times$ ” (as opposed to “ $\mathcal{O}^\triangleright$ ”), in which case the natural isomorphism of Remark 3.2.1 is *only determined up to a  $\widehat{\mathbb{Z}}^\times$ -multiple* (cf. [Mzk17], Remark 2.4.2).

PROPOSITION 3.3 (Unit Kummer Maps). *Let  $\mathbb{T} \in \{\text{TLG}, \text{TCG}\}$ . Let  $(\Pi \curvearrowright M) \in \text{Ob}(\mathcal{C}_{\mathbb{T}}^{\text{MLF}})$  be an MLF-Galois  $\mathbb{T}$ -pair, with arithmetic Galois group  $\Pi \twoheadrightarrow G$ . Then:*

(i) *By considering the action of open subgroups  $H \subseteq \Pi$  on elements of  $M$  that are roots of elements of  $M^H$  (i.e., the subgroup of  $M$  consisting of  $H$ -invariant elements), we obtain a functorial (i.e., relative to  $\mathcal{C}_{\mathbb{T}}^{\text{MLF}}$ , in the evident sense) algorithm for constructing the Kummer maps*

$$M^H \rightarrow H^1(H, \mu_{\widehat{\mathbb{Z}}}(M)); \quad M \rightarrow \varinjlim_J H^1(J, \mu_{\widehat{\mathbb{Z}}}(M))$$

— where “ $J$ ” ranges over the open subgroups of  $\Pi$ . In this situation (unlike the situation of Proposition 3.2, (ii)), the natural isomorphism  $\mu_{\widehat{\mathbb{Z}}}(M) \xrightarrow{\sim} \mu_{\widehat{\mathbb{Z}}}(G)$  (cf. Remark 3.2.1) is only determined up to a  $\{\pm 1\}$ - (respectively,  $\widehat{\mathbb{Z}}^\times$ -)multiple if  $\mathbb{T} = \text{TLG}$  (respectively,  $\mathbb{T} = \text{TCG}$ ) (cf. (ii) below; [Mzk17], Remark 2.4.2, in the case  $\mathbb{T} = \text{TCG}$ ).

(ii) *If  $(\Pi^* \curvearrowright M^*) \in \text{Ob}(\mathcal{C}_{\mathbb{T}}^{\text{MLF}})$ , then any isomorphism  $(\Pi \curvearrowright M) \xrightarrow{\sim} (\Pi^* \curvearrowright M^*)$  induces isomorphisms  $\Pi \xrightarrow{\sim} \Pi^*$ ,  $\mu_{\widehat{\mathbb{Z}}}(M) \xrightarrow{\sim} \mu_{\widehat{\mathbb{Z}}}(M^*)$ , which determine an injection*

$$\begin{aligned} & \text{Isom}_{\mathcal{C}_{\mathbb{T}}^{\text{MLF}}}((\Pi \curvearrowright M), (\Pi^* \curvearrowright M^*)) \\ & \hookrightarrow \text{Isom}_{\text{TCG}}(\Pi, \Pi^*) \times \text{Isom}_{\text{TCG}}(\mu_{\widehat{\mathbb{Z}}}(M), \mu_{\widehat{\mathbb{Z}}}(M^*)) \end{aligned}$$

— which is a bijection if  $\mathbb{T} = \text{TCG}$ . If  $\mathbb{T} = \text{TLG}$ , then the homomorphism  $\text{Isom}_{\mathcal{C}_{\mathbb{T}}^{\text{MLF}}}((\Pi \curvearrowright M), (\Pi^* \curvearrowright M^*)) \rightarrow \text{Isom}_{\text{TCG}}(\Pi, \Pi^*)$  is surjective, with fibers of cardinality two.

PROOF. The portion of assertion (i) concerning *Kummer maps* is immediate from the definitions and the references quoted. The portion of assertion (i) concerning the *isomorphism*  $\mu_{\widehat{\mathbb{Z}}}(M) \xrightarrow{\sim} \mu_{\widehat{\mathbb{Z}}}(G)$  follows by observing that the *algorithm* of Proposition 3.2, (i) (cf. also Remark 3.2.1) may

be applied, up to a  $\{\pm 1\}$ - (respectively,  $\widehat{\mathbb{Z}}^\times$ -) *indeterminacy*, if  $\mathbb{T} = \text{TLG}$  (respectively,  $\mathbb{T} = \text{TCG}$ ). The *injectivity portion* of assertion (ii) follows from assertion (i) via a similar argument to the argument used to derive the injectivity portion of Proposition 3.2, (iv), from Proposition 3.2, (i), (ii); the *surjectivity* onto  $\text{Isom}_{\mathbb{TG}}(\Pi, \Pi^*)$  follows from a similar argument to the argument applied to prove the surjectivity portion of Proposition 3.2, (iv). If  $\mathbb{T} = \text{TCG}$  (respectively,  $\mathbb{T} = \text{TLG}$ ), then the remainder of assertion (ii) follows by observing that there is a natural action of  $\widehat{\mathbb{Z}}^\times$  on  $M$  (respectively, observing that as soon as an automorphism of  $(\Pi \curvearrowright M)$  preserves the submonoid  $\mathcal{O}_k^\geq \subseteq \overline{k}^\times \cong M$  (i.e., preserves the “positive elements” of  $\overline{k}^\times / \mathcal{O}_k^\times \cong \mathbb{Q}$ ), one may apply the functorial algorithm of Proposition 3.2, (i)).  $\square$

LEMMA 3.4 (Topological Distinguishability of Additive and Multiplicative Structures). *In the notation of Definition 3.1, (i), let  $\alpha : k^\times \xrightarrow{\sim} k^\times$  be an automorphism of the topological group  $k^\times$ ,  $\alpha^{\text{pf}} : (k^\times)^{\text{pf}} \rightarrow (k^\times)^{\text{pf}}$  the automorphism induced on the perfection. Then  $\alpha^{\text{pf}}((\mathcal{O}_k^\geq)^{\text{pf}}) \not\subseteq (\mathcal{O}_k^\times)^{\text{pf}}$ .*

PROOF. Indeed, since  $\mathcal{O}_k^\times$  is easily verified to be the *maximal compact subgroup* of  $k^\times$ ,  $\alpha$  induces an isomorphism  $\mathcal{O}_k^\times \xrightarrow{\sim} \mathcal{O}_k^\times$ . Thus,  $\alpha^{\text{pf}}((\mathcal{O}_k^\times)^{\text{pf}}) = (\mathcal{O}_k^\times)^{\text{pf}}$ , so an inclusion  $\alpha^{\text{pf}}((\mathcal{O}_k^\geq)^{\text{pf}}) \subseteq (\mathcal{O}_k^\times)^{\text{pf}}$  would imply that  $(\mathcal{O}_k^\geq)^{\text{pf}} \subseteq (\mathcal{O}_k^\times)^{\text{pf}}$ , a contradiction.  $\square$

DEFINITION 3.5.

(i) We shall refer to as a *diagram of categories*  $\mathcal{D} = (\vec{\Gamma}_{\mathcal{D}}, \{\mathcal{D}_v\}, \{\mathcal{D}_e\})$  any collection of data as follows:

- (a) an *oriented graph*  $\vec{\Gamma}_{\mathcal{D}}$  (cf. §0);
- (b) for each *vertex*  $v$  of  $\vec{\Gamma}_{\mathcal{D}}$ , a *category*  $\mathcal{D}_v$ ;
- (c) for each *edge*  $e$  of  $\vec{\Gamma}_{\mathcal{D}}$  that runs from a vertex  $v_1$  to a vertex  $v_2$ , a *functor*  $\mathcal{D}_e : \mathcal{D}_{v_1} \rightarrow \mathcal{D}_{v_2}$ .

Let  $\mathcal{D} = (\vec{\Gamma}_{\mathcal{D}}, \{\mathcal{D}_v\}, \{\mathcal{D}_e\})$  be a diagram of categories. Then observe that any *path*  $[\gamma]$  (cf. §0) on  $\vec{\Gamma}_{\mathcal{D}}$  that runs from a vertex  $v_1$  to a vertex  $v_2$  determines — i.e., by composing the various functors “ $\mathcal{D}_e$ ”, for edges  $e$  that appear in this path — a functor  $\mathcal{D}_{[\gamma]} : \mathcal{D}_{v_1} \rightarrow \mathcal{D}_{v_2}$ . We shall refer to the

diagram of categories  $\mathcal{E}$  obtained by restricting the data of  $\mathcal{D}$  to an oriented subgraph  $\vec{\Gamma}_{\mathcal{E}}$  of  $\vec{\Gamma}_{\mathcal{D}}$  as a *subdiagram of categories* of  $\mathcal{D}$ .

(ii) Let  $\mathcal{D} = (\vec{\Gamma}_{\mathcal{D}}, \{\mathcal{D}_v\}, \{\mathcal{D}_e\})$  be a diagram of categories. Then we shall refer to as a *family of homotopies*  $\mathcal{H} = (E_{\mathcal{H}}, \{\zeta_{\varpi}\})$  on  $\mathcal{D}$  any collection of data as follows:

- (a) a *saturated* (cf. §0) set  $E_{\mathcal{H}} \subseteq \Omega(\vec{\Gamma}_{\mathcal{D}}) \times \Omega(\vec{\Gamma}_{\mathcal{D}})$  of ordered pairs of paths on  $\vec{\Gamma}_{\mathcal{D}}$ , which we shall refer to as the *boundary set* of the family of homotopies  $\mathcal{H}$ ; we shall refer to every path on  $\vec{\Gamma}_{\mathcal{D}}$  that occurs as a component of an element of  $E_{\mathcal{H}}$  as a *boundary set path*;
- (b) for each  $\varpi = ([\gamma_1], [\gamma_2]) \in E_{\mathcal{H}}$ , a *natural transformation*  $\zeta_{\varpi} : \mathcal{D}_{[\gamma_1]} \rightarrow \mathcal{D}_{[\gamma_2]}$  — which we shall refer to as a *homotopy* from  $[\gamma_1]$  to  $[\gamma_2]$  — such that the following conditions are satisfied:  $\zeta_{([\gamma], [\gamma])}$  is the *identity* natural transformation for each  $([\gamma], [\gamma]) \in E_{\mathcal{H}}$ ; if  $\varpi = ([\gamma_1], [\gamma_2])$ ,  $\varpi' = ([\gamma_2], [\gamma_3])$ , and  $\varpi'' = ([\gamma_1], [\gamma_3])$  belong to  $E_{\mathcal{H}}$ , then  $\zeta_{\varpi''} = \zeta_{\varpi'} \circ \zeta_{\varpi}$ ; if, for some  $[\gamma_3], [\gamma_4] \in \Omega(\vec{\Gamma}_{\mathcal{D}})$ , the pairs  $\varpi = ([\gamma_1], [\gamma_2])$  and  $\varpi' = ([\gamma_3] \circ [\gamma_1] \circ [\gamma_4], [\gamma_3] \circ [\gamma_2] \circ [\gamma_4])$  belong to  $E_{\mathcal{H}}$ , then  $\zeta_{\varpi'} = \mathcal{D}_{[\gamma_3]} \circ \zeta_{\varpi} \circ \mathcal{D}_{[\gamma_4]}$ .

If, in this situation,  $E_{\mathcal{H}}$  is the *smallest* (cf. §0) saturated subset of  $\Omega(\vec{\Gamma}_{\mathcal{D}}) \times \Omega(\vec{\Gamma}_{\mathcal{D}})$  that contains a given subset  $E_{\mathcal{H}}^* \subseteq E_{\mathcal{H}}$ , then we shall say that the family of homotopies  $\mathcal{H} = (E_{\mathcal{H}}, \{\zeta_{\varpi}\})$  is *generated* by the homotopies indexed by  $E_{\mathcal{H}}^*$ . We shall refer to a family of homotopies  $\mathcal{H} = (E_{\mathcal{H}}, \{\zeta_{\varpi}\})$  on  $\mathcal{D}$  as *symmetric* if  $E_{\mathcal{H}}$  is *symmetrically saturated* (cf. §0). (Thus, if  $\mathcal{H} = (E_{\mathcal{H}}, \{\zeta_{\varpi}\})$  is symmetric, then every  $\zeta_{\varpi}$  is an *isomorphism*.) We shall refer to a collection of families of homotopies  $\{\mathcal{H}_{\iota} = (E_{\mathcal{H}_{\iota}}, \{\zeta_{\varpi_{\iota}}^{\iota}\})\}_{\iota \in I}$  on  $\mathcal{D}$  as being *compatible* if there exists a family of homotopies  $\mathcal{H} = (E_{\mathcal{H}}, \{\zeta_{\varpi}\})$  on  $\mathcal{D}$  such that, for each  $\iota \in I$ ,  $\varpi_{\iota} \in E_{\mathcal{H}_{\iota}}$ , we have  $E_{\mathcal{H}_{\iota}} \subseteq E_{\mathcal{H}}$  and  $\zeta_{\varpi_{\iota}}^{\iota} = \zeta_{\varpi_{\iota}}$ .

(iii) Let  $\mathcal{D} = (\vec{\Gamma}_{\mathcal{D}}, \{\mathcal{D}_v\}, \{\mathcal{D}_e\})$  be a diagram of categories. Then we shall refer to as an *observable*  $\mathfrak{S} = (\mathcal{S}, v_{\mathfrak{S}}, \mathcal{H})$  (*on*  $\mathcal{D}$ ) any collection of data as follows:

- (a) a *diagram of categories*  $\mathcal{S} = (\vec{\Gamma}_{\mathcal{S}}, \{\mathcal{S}_v\}, \{\mathcal{S}_e\})$  that contains  $\mathcal{D}$  as a *subdiagram of categories* (so  $\vec{\Gamma}_{\mathcal{D}} \subseteq \vec{\Gamma}_{\mathcal{S}}$ );

- (b) a vertex  $v_{\mathfrak{S}}$  of  $\vec{\Gamma}_{\mathcal{S}}$ , which we shall refer to as the *observation vertex*, such that the set of vertices of  $\vec{\Gamma}_{\mathcal{S}} \setminus \vec{\Gamma}_{\mathcal{D}}$  is equal to  $\{v_{\mathfrak{S}}\}$ , and, moreover, every edge of  $\vec{\Gamma}_{\mathcal{S}} \setminus \vec{\Gamma}_{\mathcal{D}}$  runs from a vertex of  $\vec{\Gamma}_{\mathcal{D}}$  to  $v_{\mathfrak{S}}$ ;
- (c) a *family of homotopies*  $\mathcal{H}$  on  $\mathcal{S}$  such that every boundary set path of  $\mathcal{H}$  has *terminal vertex* equal to  $v_{\mathfrak{S}}$ .

Let  $\mathfrak{S} = (\mathcal{S}, v_{\mathfrak{S}}, \mathcal{H})$  be an observable on  $\mathcal{D}$ . Then we shall say that  $\mathfrak{S}$  is *symmetric* if  $\mathcal{H}$  is symmetric. We shall say that  $\mathfrak{S}$  is a *core (on  $\mathcal{D}$ )* if the boundary set of  $\mathcal{H}$  is equal to the set of *all* co-verticial pairs of paths on the underlying oriented graph  $\vec{\Gamma}_{\mathcal{S}}$  of  $\mathcal{S}$  with terminal vertex equal to  $v_{\mathfrak{S}}$  (which implies that  $\mathfrak{S}$  is *symmetric*), and, moreover, every vertex of  $\vec{\Gamma}_{\mathcal{D}}$  appears as the initial vertex of a path on  $\vec{\Gamma}_{\mathcal{S}}$  with terminal vertex equal to  $v_{\mathfrak{S}}$ . Suppose that  $\mathfrak{S}$  is a *core* on  $\mathcal{D}$ . Then we shall refer to the observation vertex of  $\mathfrak{S}$  as the *core vertex* of  $\mathfrak{S}$  and (by abuse of terminology, when there is no fear of confusion) to  $\mathcal{S}_{v_{\mathfrak{S}}}$  as a “*core on  $\mathcal{D}$* ”.

(iv) Let  $\mathfrak{S} = (\mathcal{S}, v_{\mathfrak{S}}, \mathcal{H})$  be a *core* on a diagram of categories  $\mathcal{D} = (\vec{\Gamma}_{\mathcal{D}}, \{\mathcal{D}_v\}, \{\mathcal{D}_e\})$ . Then we shall refer to as a *telecore*  $\mathfrak{T} = (\mathcal{T}, \mathcal{J})$  on  $\mathcal{D}$  over the core  $\mathfrak{S}$  any collection of data as follows:

- (a) a *diagram of categories*  $\mathcal{T} = (\vec{\Gamma}_{\mathcal{T}}, \{\mathcal{T}_v\}, \{\mathcal{T}_e\})$  that contains  $\mathcal{S}$  as a *subdiagram of categories* (so  $\vec{\Gamma}_{\mathcal{D}} \subseteq \vec{\Gamma}_{\mathcal{S}} \subseteq \vec{\Gamma}_{\mathcal{T}}$ ) such that  $\vec{\Gamma}_{\mathcal{T}}, \vec{\Gamma}_{\mathcal{S}}$  have the *same vertices*, and, moreover, every edge of  $\vec{\Gamma}_{\mathcal{T}} \setminus \vec{\Gamma}_{\mathcal{S}}$  runs from  $v_{\mathfrak{S}}$  to a vertex of  $\vec{\Gamma}_{\mathcal{D}}$ ; we shall refer to such edges of  $\vec{\Gamma}_{\mathcal{T}}$  as the *telecore edges*;
- (b)  $\mathcal{J}$  is a *family of homotopies* on  $\mathcal{T}$  such that  $\mathcal{J}|_{\mathcal{S}} = \mathcal{H}$  whose boundary set is equal to the subset of  $\Omega(\vec{\Gamma}_{\mathcal{T}})$  of pairs  $([\gamma_3] \circ [\gamma_1], [\gamma_3] \circ [\gamma_2])$ , where  $([\gamma_1], [\gamma_2])$  is a co-verticial pair of paths on  $\vec{\Gamma}_{\mathcal{T}}$  with terminal vertex equal to  $v_{\mathfrak{S}}$ , and  $[\gamma_3]$  is a path on  $\vec{\Gamma}_{\mathcal{T}}$  with initial vertex equal to  $v_{\mathfrak{S}}$ .

In this situation, a family of homotopies  $\mathcal{H}^{\text{cnct}}$  on  $\mathcal{T}$  that is *compatible* with  $\mathcal{J}$  will be referred to as a *contact structure* for the telecore  $\mathcal{T}$ .

(v) Let  $\mathcal{D} = (\vec{\Gamma}_{\mathcal{D}}, \{\mathcal{D}_v\}, \{\mathcal{D}_e\})$  and  $\mathcal{D}' = (\vec{\Gamma}_{\mathcal{D}'}, \{\mathcal{D}'_v\}, \{\mathcal{D}'_e\})$  be *diagrams of categories*. Then a *1-morphism of diagrams of categories*

$$\Phi : \mathcal{D} \rightarrow \mathcal{D}'$$

is defined to be a collection of data follows:

- (a) a *morphism of oriented graphs*  $\Phi_{\vec{\Gamma}} : \vec{\Gamma}_{\mathcal{D}} \rightarrow \vec{\Gamma}_{\mathcal{D}'}$ ;
- (b) for each *vertex*  $v$  of  $\vec{\Gamma}_{\mathcal{D}}$ , a *functor*  $\Phi_v : \mathcal{D}_v \rightarrow \mathcal{D}'_{\Phi_{\vec{\Gamma}}(v)}$ ;
- (c) for each *edge*  $e$  of  $\vec{\Gamma}_{\mathcal{D}}$  that runs from a vertex  $v_1$  to a vertex  $v_2$ ,  
an *isomorphism of functors*  $\Phi_e : \mathcal{D}'_{\Phi_{\vec{\Gamma}}(e)} \circ \Phi_{v_1} \xrightarrow{\sim} \Phi_{v_2} \circ \mathcal{D}_e$ .

A 2-*morphism*  $\Theta : \Phi \rightarrow \Psi$  between 1-morphisms  $\Phi, \Psi : \mathcal{D} \rightarrow \mathcal{D}'$  such that  $\Phi_{\vec{\Gamma}} = \Psi_{\vec{\Gamma}}$  is defined to be a collection of natural transformations  $\{\Theta_v : \Phi_v \rightarrow \Psi_v\}$ , where  $v$  ranges over the vertices of  $\vec{\Gamma}_{\mathcal{D}}$ , such that

$$\Psi_e \circ (\mathcal{D}'_{\Phi_{\vec{\Gamma}}(e)} \circ \Theta_{v_1}) = (\Theta_{v_2} \circ \mathcal{D}_e) \circ \Phi_e : \mathcal{D}'_{\Phi_{\vec{\Gamma}}(e)} \circ \Phi_{v_1} \rightarrow \Psi_{v_2} \circ \mathcal{D}_e$$

for each *edge*  $e$  of  $\vec{\Gamma}_{\mathcal{D}}$  that runs from a vertex  $v_1$  to a vertex  $v_2$ . We shall say that a 1-morphism  $\Phi : \mathcal{D} \rightarrow \mathcal{D}'$  is an *equivalence of diagrams of categories* if there exists a 1-morphism  $\Psi : \mathcal{D}' \rightarrow \mathcal{D}$  such that  $\Psi \circ \Phi, \Phi \circ \Psi$  are (2-)isomorphic to the respective identity 1-morphisms of  $\mathcal{D}, \mathcal{D}'$ . If  $\mathcal{D}$  (respectively,  $\mathcal{D}'$ ) is equipped with a *family of homotopies*  $\mathcal{H}$  (respectively,  $\mathcal{H}'$ ), then we shall say that an equivalence  $\Phi : \mathcal{D} \xrightarrow{\sim} \mathcal{D}'$  is *compatible* with  $\mathcal{H}, \mathcal{H}'$  if  $\Phi_{\vec{\Gamma}}$  induces a bijection between the boundary sets of  $\mathcal{H}, \mathcal{H}'$ , and, moreover, the natural transformations that constitute  $\mathcal{H}, \mathcal{H}'$  (cf. the data of (ii), (b)) are compatible (in the evident sense) with the natural transformations that constitute  $\Phi$  (cf. the data (c) in the above definition); in this situation, one verifies immediately that if  $\Phi$  is compatible with  $\mathcal{H}, \mathcal{H}'$ , then so is any equivalence  $\Psi : \mathcal{D} \xrightarrow{\sim} \mathcal{D}'$  that is isomorphic to  $\Phi$ . We shall say that  $\mathcal{D}$  is *vertex-rigid* (respectively, *edge-rigid*) if, for every vertex  $v$  (respectively, edge  $e$ ) of  $\vec{\Gamma}_{\mathcal{D}}$ , the category  $\mathcal{D}_v$  (respectively, the functor  $\mathcal{D}_e$ ) is id-rigid (respectively, rigid) (cf. §0). If  $\mathcal{D}$  is vertex-rigid and edge-rigid, then we shall say that  $\mathcal{D}$  is *totally rigid*. Thus, if  $\mathcal{D}$  is *edge-rigid*, then any equivalence  $\Phi : \mathcal{D} \xrightarrow{\sim} \mathcal{D}'$  is *completely determined* by  $\Phi_{\vec{\Gamma}}$  and the  $\{\Phi_v\}$  (i.e., the data (a), (b) in the above definition). In a similar vein, if  $\mathcal{D}$  is *vertex-rigid*, then any two isomorphic equivalences  $\Phi, \Psi : \mathcal{D} \xrightarrow{\sim} \mathcal{D}'$  admit a *unique* (2-)isomorphism  $\Phi \xrightarrow{\sim} \Psi$ . In particular, if  $\mathcal{D}$  is *vertex-rigid*, then it is natural to speak of the *automorphism group*  $\text{Aut}(\mathcal{D})$  of  $\mathcal{D}$ , i.e., the group determined by the *isomorphism classes of self-equivalences* of  $\mathcal{D}$ .

(vi) Let  $\mathcal{D} = (\vec{\Gamma}_{\mathcal{D}}, \{\mathcal{D}_v\}, \{\mathcal{D}_e\})$  be a *diagram of categories*;  $\square$  a *nexus* of  $\vec{\Gamma}_{\mathcal{D}}$  (cf. §0);  $\mathcal{D}_{\leq \square}, \mathcal{D}_{\geq \square}$  the *subdiagrams of categories* determined, respectively, by the *pre- and post-nexus portions* of  $\vec{\Gamma}_{\mathcal{D}}$  (cf. §0). Then we shall say

that  $\mathcal{D}$  is *totally*  $\square$ -*rigid* if the pre-nexus portion  $\mathcal{D}_{\leq \square}$  is *totally rigid*. Let us suppose that  $\mathcal{D}$  is *totally*  $\square$ -*rigid*. Write

$$\text{Aut}_{\square}(\mathcal{D}_{\leq \square}) \subseteq \text{Aut}(\mathcal{D}_{\leq \square})$$

for the subgroup of isomorphism classes of self-equivalences of  $\mathcal{D}_{\leq \square}$  that preserve  $\square$  and induce a self-equivalence of  $\mathcal{D}_{\square}$  that is isomorphic to the identity self-equivalence. Let  $\Phi_{\leq \square} : \mathcal{D}_{\leq \square} \xrightarrow{\sim} \mathcal{D}_{\leq \square}$  be a self-equivalence whose isomorphism class  $[\Phi_{\leq \square}] \in \text{Aut}_{\square}(\mathcal{D}_{\leq \square})$ . Then  $\Phi_{\leq \square}$  *extends naturally* to an equivalence  $\Phi : \mathcal{D} \xrightarrow{\sim} \mathcal{D}$  which is the *identity* on  $\vec{\Gamma}_{\mathcal{D}_{\geq \square}}$  and which associates to each vertex  $v \neq \square$  of  $\vec{\Gamma}_{\mathcal{D}_{\geq \square}}$  the identity self-equivalence of  $\mathcal{D}_v$ . (Here, we observe that the isomorphism of functors of (v), (c), is naturally determined by the isomorphism of  $(\Phi_{\leq \square})_{\square}$  with the identity self-equivalence of  $\mathcal{D}_{\square}$ .) Moreover, this assignment

$$\Phi_{\leq \square} \mapsto \Phi$$

clearly maps isomorphic equivalences to isomorphic equivalences and is compatible with composition of equivalences. In particular, this assignment yields a *natural “action”* of the group  $\text{Aut}_{\square}(\mathcal{D}_{\leq \square})$  on  $\mathcal{D}$ . We shall refer to the resulting self-equivalences of  $\mathcal{D}$  as *nexus self-equivalences* of  $\mathcal{D}$  (relative to the nexus  $\square$ ) and the resulting classes of self-equivalences of  $\mathcal{D}$  (i.e., arising from isomorphism classes of “ $\Phi_{\leq \square}$ ”) as *nexus-classes of self-equivalences* of  $\mathcal{D}$  (relative to the nexus  $\square$ ).

REMARK 3.5.1. If one just works with *diagrams of categories* without considering any observables, then it is difficult to understand the “*global structure*” of the diagram since (by definition!) it *does not make sense* to speak of the relationship between objects that belong to *different categories* (e.g., at distinct vertices of the diagram). Thus:

The notion of an *observable* may be thought of as a sort of “*partial projection of the dynamics of a diagram of categories*” onto a *single* category, within which it makes sense to compare objects that arise from distinct categories at distinct vertices of the diagram.

Moreover:

A *core* on a diagram of categories may be thought of as an extraction of a certain portion of the data of the objects at the various categories in the diagram that is *invariant* with respect to the “dynamics” arising from the application of the various functors in the diagram.

Put another way, one may think of a core as a sort of “*constant portion*” of the diagram that lies, in a consistent fashion, “*under the entire diagram*” (cf. the use of the term “core” in the theory of [Mzk11], §2). Then:

A *telecore* may be thought of as a sort of *partial section* — i.e., given by the *telecore edges* — of the “structure morphisms to the core” which does not disturb the *coricity* (i.e., the property of being a core) of the original core.

Moreover, although, in the definition of a telecore, we do not assume the existence of families of homotopies that guarantee the compatibility of applying composites of functors by traveling along *arbitrary* co-verticial pairs of paths emanating from the *core vertex*, any *failure of such a compatibility* may always be *eliminated* — in a fashion reminiscent of a “*telescoping sum*” — by projecting back down to the *core vertex* (cf. the discussion of Remark 3.6.1, (ii), (c), below). Put another way, one may think of a telecore as a device that satisfies a sort of “*time lag compatibility*”, i.e., as a device whose “compatibility apparatus” does not go into operation immediately, but only after a certain “time lag” (arising from the necessity to travel back down to the core vertex). Also, for more on the meaning of cores and telecores, we refer to Remark 3.6.5 below.

The terminology of Definition 3.5 makes it possible to formulate the *first main result* of the present §3.

COROLLARY 3.6 (MLF-Galois-theoretic Mono-anabelian Log-Frobenius Compatibility). *Write*

$$\mathcal{X} \stackrel{\text{def}}{=} \underline{\underline{\mathcal{C}}}_{\mathbb{T}}^{\text{MLF-sB}}, \quad \mathcal{E} \stackrel{\text{def}}{=} \underline{\underline{\mathbb{T}}}\mathbb{G}^{\text{sB}}, \quad \mathcal{N} \stackrel{\text{def}}{=} \overline{\underline{\underline{\mathcal{C}}}}_{\mathbb{T}\mathbb{S}}^{\text{MLF-sB}}$$

— where (in the notation of Definition 3.1)  $\mathbb{T} \in \{\text{TM}, \text{TF}\}$ . Consider the

diagram of categories  $\mathcal{D}$

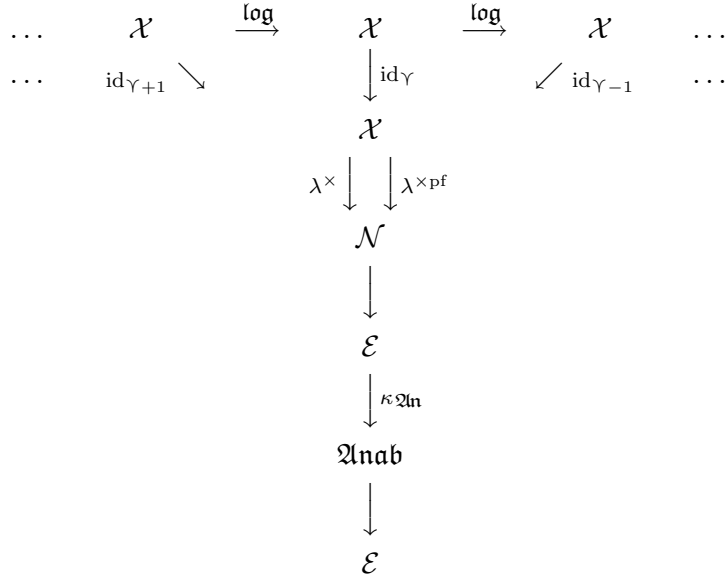

— where we use the notation “ $\log$ ”, “ $\lambda^{\times}$ ”, “ $\lambda^{\times \text{pf}}$ ” for the evident (double-underlined/ overlined) restrictions of the arrows “ $\log_{\mathbb{T}, \mathbb{T}}$ ”, “ $\lambda^{\times}$ ”, “ $\lambda^{\times \text{pf}}$ ” of Definition 3.1, (iv) (cf. also Proposition 3.2, (iii), (v)); for positive integers  $n \leq 6$ , we shall denote by  $\mathcal{D}_{\leq n}$  the subdiagram of categories of  $\mathcal{D}$  determined by the first  $n$  (of the six) rows of  $\mathcal{D}$ ; we write  $L$  for the countably ordered set determined (cf. §0) by the infinite linear oriented graph  $\vec{\Gamma}_{\mathcal{D}_{\leq 1}}^{\text{opp}}$  (so the elements of  $L$  correspond to vertices of the first row of  $\mathcal{D}$ ) and

$$L^{\dagger} \stackrel{\text{def}}{=} L \cup \{\square\}$$

for the ordered set obtained by appending to  $L$  a formal symbol  $\square$  (which we think of as corresponding to the unique vertex of the second row of  $\mathcal{D}$ ) such that  $\square < \Upsilon$ , for all  $\Upsilon \in L$ ;  $\text{id}_{\Upsilon}$  denotes the identity functor at the vertex  $\Upsilon \in L$ ; the notation “ $\dots$ ” denotes an infinite repetition of the evident pattern. Then:

- (i) For  $n = 4, 5, 6$ ,  $\mathcal{D}_{\leq n}$  admits a natural structure of core on  $\mathcal{D}_{\leq n-1}$ . That is to say, loosely speaking,  $\mathcal{E}$ ,  $\mathfrak{Anab}$  “form cores” of the functors in  $\mathcal{D}$ .



(ii) The assignments

$$\left( \Pi, \Pi \curvearrowright \{\bar{k}^\times \hookrightarrow \varinjlim_J H^1(J, \mu_{\mathbb{Z}}(\Pi))\} \right) \mapsto (\Pi \curvearrowright \mathcal{O}_k^\times, \quad (\Pi \curvearrowright \bar{k}^\times \cup \{0\})$$

determine (i.e., for each choice of  $\mathbb{T}$ ) a natural “forgetful” functor

$$\mathfrak{Anab} \xrightarrow{\phi_{\mathfrak{An}}} \mathcal{X}$$

which is an equivalence of categories, a quasi-inverse for which is given by the composite  $\pi_{\mathfrak{An}} : \mathcal{X} \rightarrow \mathfrak{Anab}$  of the natural projection functor  $\mathcal{X} \rightarrow \mathcal{E}$  with  $\kappa_{\mathfrak{An}} : \mathcal{E} \rightarrow \mathfrak{Anab}$ ; write  $\eta_{\mathfrak{An}} : \phi_{\mathfrak{An}} \circ \pi_{\mathfrak{An}} \xrightarrow{\sim} \text{id}_{\mathcal{X}}$  for the isomorphism arising from the “group-theoretic” algorithms of Corollary 1.10 (cf. also Proposition 3.2, (ii), (iii)). Moreover,  $\phi_{\mathfrak{An}}$  gives rise to a telecore structure  $\mathfrak{T}_{\mathfrak{An}}$  on  $\mathcal{D}_{\leq 4}$ , whose underlying diagram of categories we denote by  $\mathcal{D}_{\mathfrak{An}}$ , by appending to  $\mathcal{D}_{\leq 5}$  telecore edges

$$\begin{array}{ccccccc} & & & \mathfrak{Anab} & & & \\ & & & \downarrow \phi_\gamma & & \searrow \phi_{\gamma-1} & \\ \dots & \phi_{\gamma+1} \swarrow & & & & & \dots \\ & \mathcal{X} & \xrightarrow{\log} & \mathcal{X} & \xrightarrow{\log} & \mathcal{X} & \\ & & & \mathfrak{Anab} & \xrightarrow{\phi_\square} & \mathcal{X} & \end{array}$$

from the core  $\mathfrak{Anab}$  to the various copies of  $\mathcal{X}$  in  $\mathcal{D}_{\leq 2}$  given by copies of  $\phi_{\mathfrak{An}}$ , which we denote by  $\phi_\lambda$ , for  $\lambda \in L^\dagger$ . That is to say, loosely speaking,  $\phi_{\mathfrak{An}}$  determines a telecore structure on  $\mathcal{D}_{\leq 4}$ . Finally, for each  $\lambda \in L^\dagger$ , let us write  $[\beta_\lambda^0]$  for the path on  $\vec{\Gamma}_{\mathcal{D}_{\mathfrak{An}}}$  of length 0 at  $\lambda$  and  $[\beta_\lambda^1]$  for the path on  $\vec{\Gamma}_{\mathcal{D}_{\mathfrak{An}}}$  of length  $\in \{4, 5\}$  (i.e., depending on whether or not  $\lambda = \square$ ) that starts from  $\lambda$ , descends (say, via  $\lambda^\times$ ) to the core vertex “ $\mathfrak{Anab}$ ”, and returns to  $\lambda$  via the telecore edge  $\phi_\lambda$ . Then the collection of natural transformations

$$\{\eta_{\square\gamma}, \eta_{\square\gamma}^{-1}, \eta_\lambda, \eta_\lambda^{-1}\}_{\gamma \in L, \lambda \in L^\dagger}$$

— where we write  $\eta_{\square\gamma}$  for the identity natural transformation from the arrow  $\phi_\square : \mathfrak{Anab} \rightarrow \mathcal{X}$  to the composite arrow  $\text{id}_\gamma \circ \phi_\gamma : \mathfrak{Anab} \rightarrow \mathcal{X}$  and

$$\eta_\lambda : (\mathcal{D}_{\mathfrak{An}})_{[\beta_\lambda^1]} \xrightarrow{\sim} (\mathcal{D}_{\mathfrak{An}})_{[\beta_\lambda^0]}$$

for the isomorphism arising from  $\eta_{\mathfrak{An}}$  — generate a contact structure  $\mathcal{H}_{\mathfrak{An}}$  on the telecore  $\mathfrak{T}_{\mathfrak{An}}$ .

(iii) *The natural transformations*

$$\underline{\text{log}}_{\gamma} : \lambda^{\times} \circ \text{id}_{\gamma} \circ \text{log} \rightarrow \lambda^{\times \text{Pf}} \circ \text{id}_{\gamma+1}, \quad \underline{\text{L}}_{\times} : \lambda^{\times} \rightarrow \lambda^{\times \text{Pf}}$$

(cf. Definition 3.1, (iv)) *belong to a family of homotopies on  $\mathcal{D}_{\leq 3}$  that determines on  $\mathcal{D}_{\leq 3}$  a structure of observable  $\mathfrak{S}_{\text{log}}$  on  $\mathcal{D}_{\leq 2}$  and, moreover, is compatible with the families of homotopies that constitute the core and telecore structures of (i), (ii).*

(iv) *The diagram of categories  $\mathcal{D}_{\leq 2}$  does not admit a structure of core on  $\mathcal{D}_{\leq 1}$  which (i.e., whose constituent family of homotopies) is compatible with (the constituent family of homotopies of) the observable  $\mathfrak{S}_{\text{log}}$  of (iii). Moreover, the telecore structure  $\mathfrak{T}_{\mathfrak{A}\mathfrak{n}}$  of (ii), the contact structure  $\mathcal{H}_{\mathfrak{A}\mathfrak{n}}$  of (ii), and the observable  $\mathfrak{S}_{\text{log}}$  of (iii) are not simultaneously compatible (but cf. Remark 3.7.3, (ii), below).*

(v) *The unique vertex  $\square$  of the second row of  $\mathcal{D}$  is a nexus of  $\vec{\Gamma}_{\mathcal{D}}$ . Moreover,  $\mathcal{D}$  is totally  $\square$ -rigid, and the natural action of  $\mathbb{Z}$  on the infinite linear oriented graph  $\vec{\Gamma}_{\mathcal{D}_{\leq 1}}$  extends to an action of  $\mathbb{Z}$  on  $\mathcal{D}$  by nexus-classes of self-equivalences of  $\mathcal{D}$ . Finally, the self-equivalences in these nexus-classes are compatible with the families of homotopies that constitute the cores and observable of (i), (iii); these self-equivalences also extend naturally (cf. the technique of extension applied in Definition 3.5, (vi)) to the diagram of categories (cf. Definition 3.5, (iv), (a)) that constitutes the telecore of (ii), in a fashion that is compatible with both the family of homotopies that constitutes this telecore structure (cf. Definition 3.5, (iv), (b)) and the contact structure  $\mathcal{H}_{\mathfrak{A}\mathfrak{n}}$  of (ii).*

PROOF. In the following, if  $\phi$  is a functor appearing in  $\mathcal{D}$ , then let us write  $[\phi]$  for the *path* on the underlying oriented graph  $\vec{\Gamma}_{\mathcal{D}}$  of  $\mathcal{D}$  determined by the edge corresponding to  $\phi$  (cf. §0). Now assertion (i) is immediate from the definitions and the fact that the algorithms of Corollary 1.10 are “*group-theoretic*” in the sense that they are expressed in language that depends only on the profinite group given as “input data”.

Next, we consider assertion (ii). The portion of assertion (ii) concerning  $\phi_{\mathfrak{A}\mathfrak{n}}$  and  $\mathfrak{T}_{\mathfrak{A}\mathfrak{n}}$  is immediate from the definitions and the “*group-theoretic*” algorithms of Corollary 1.10 (cf. also Proposition 3.2, (ii), (iii)). Thus, it suffices to show the existence of a *contact structure*  $\mathcal{H}_{\mathfrak{A}\mathfrak{n}}$  as described. To this end, let us first observe that the *isomorphism of log with the identity functor*

(cf. Definition 3.1, (iv); Proposition 3.2, (v)) is *compatible* (in the evident sense) with the natural transformations  $\{\eta_{\square\Upsilon}, \eta_{\square\Upsilon}^{-1}, \eta_\lambda, \eta_\lambda^{-1}\}_{\Upsilon \in L, \lambda \in L^\dagger}$ . On the other hand, this compatibility implies that one may, in effect, “contract”  $\mathcal{D}_{\leq 2}$  down to a *single vertex* (equipped with the category  $\mathcal{X}$ ) and the various paths from  $\square$  to  $\mathfrak{Anab}$  down to a *single edge* — i.e., that, up to *redundancies*, one is, in effect, dealing with a diagram of categories with *two vertices* “ $\mathcal{X}$ ” and “ $\mathfrak{Anab}$ ” joined by *two (oriented) edges*  $\phi_{\mathfrak{An}}, \pi_{\mathfrak{An}}$ . Now the *existence* of a family of homotopies that contains the collection of natural transformations  $\{\eta_{\square\Upsilon}, \eta_\lambda, \eta_\lambda^{-1}\}_{\Upsilon \in L, \lambda \in L^\dagger}$  follows immediately. This completes the proof of assertion (ii).

Next, we consider assertion (iii). Write  $E_{\log}$  for the set of ordered pairs of paths on  $\vec{\Gamma}_{\mathcal{D}_{\leq 3}}$  (i.e., the underlying oriented graph of  $\mathcal{D}_{\leq 3}$ ) consisting of pairs of paths of the following three types:

- (1)  $([\lambda^\times] \circ [\text{id}_\Upsilon] \circ [\log] \circ [\gamma], [\lambda^{\times \text{Pf}}] \circ [\text{id}_{\Upsilon+1}] \circ [\gamma])$ , where  $[\gamma]$  is a path on  $\mathcal{D}_{\leq 3}$  whose terminal vertex lies in the *first row* of  $\mathcal{D}_{\leq 3}$ ;
- (2)  $([\lambda^\times] \circ [\gamma], [\lambda^{\times \text{Pf}}] \circ [\gamma])$ , where  $[\gamma]$  is a path on  $\mathcal{D}_{\leq 3}$  whose terminal vertex lies in the *second row* of  $\mathcal{D}_{\leq 3}$ ;
- (3)  $([\gamma], [\gamma])$ , where  $[\gamma]$  is a path on  $\mathcal{D}_{\leq 3}$  whose terminal vertex lies in the *third row* of  $\mathcal{D}_{\leq 3}$ .

Then one verifies immediately that  $E_{\log}$  satisfies the conditions (a), (b), (c), (d), (e) given in §0 for a *saturated set*. Moreover, the natural transformation(s)  $\underline{\mathcal{L}}_{\log, \Upsilon}$  (respectively,  $\underline{\mathcal{L}}_\times$ ) determine(s) the homotopies for pairs of paths of type (1) (respectively, (2)). Thus, we obtain an *observable*  $\mathfrak{S}_{\log}$ , as desired. Moreover, it is immediate from the definitions — i.e., in essence, because the various *Galois groups* that appear remain “*undisturbed*” by the various manipulations involving *arithmetic data* that arise from “ $\underline{\mathcal{L}}_{\log, \Upsilon}$ ”, “ $\underline{\mathcal{L}}_\times$ ” — that this family of homotopies is *compatible* with the families of homotopies that constitute the *core* and *telecore* structures of (i), (ii). This completes the proof of assertion (iii).

Next, we consider assertion (iv). Suppose that  $\mathcal{D}_{\leq 2}$  admits a structure of *core* on  $\mathcal{D}_{\leq 1}$  in a fashion that is *compatible* with the observable  $\mathfrak{S}_{\log}$  of (iii). Then this *core structure* determines, for  $\Upsilon \in L$ , a homotopy  $\zeta_0$  for the pair of paths  $([\text{id}_{\Upsilon+1}], [\text{id}_\Upsilon] \circ [\log])$ ; thus, by composing the result  $\zeta'_0$  of applying  $\lambda^\times$  to  $\zeta_0$  with the homotopy  $\zeta_1$  associated (via  $\mathfrak{S}_{\log}$ ) to the pair of paths  $([\lambda^\times] \circ [\text{id}_\Upsilon] \circ [\log], [\lambda^{\times \text{Pf}}] \circ [\text{id}_{\Upsilon+1}])$  (of type (1)), we obtain a natural

transformation

$$\zeta'_1 = \zeta_1 \circ \zeta'_0 : \lambda^\times \circ \text{id}_{\gamma+1} \rightarrow \lambda^{\times\text{pf}} \circ \text{id}_{\gamma+1}$$

— which, in order for the desired *compatibility* to hold, must *coincide* with the homotopy  $\zeta_2$  associated (via  $\mathfrak{S}_{\text{log}}$ ) to the pair of paths  $([\lambda^\times] \circ [\text{id}_{\gamma+1}], [\lambda^{\times\text{pf}}] \circ [\text{id}_{\gamma+1}])$  (of type (2)). On the other hand, by writing out explicitly the meaning of such an equality  $\zeta'_1 = \zeta_2$ , we conclude that we obtain a *contradiction* to Lemma 3.4. This completes the proof of the *first incompatibility* of assertion (iv). The proof of the *second incompatibility* of assertion (iv) is entirely similar. That is to say, if we *compose on the right with*  $[\phi_{\gamma+1}]$  the various paths that appeared in the proof of the first incompatibility, then in order to apply the argument applied in the proof of the first incompatibility, it suffices to *relate* the paths

$$[\text{id}_{\gamma+1}] \circ [\phi_{\gamma+1}]; \quad [\text{id}_\gamma] \circ [\text{log}] \circ [\phi_{\gamma+1}]$$

(a task that was achieved in the proof of the first incompatibility by applying the *core structure* whose existence was assumed in the proof of the first incompatibility). In the present situation, applying the homotopy  $\eta_{\square\gamma+1}$  of the *contact structure*  $\mathcal{H}_{\mathfrak{Qn}}$  yields a homotopy  $[\phi_\square] \rightsquigarrow [\text{id}_{\gamma+1}] \circ [\phi_{\gamma+1}]$ ; on the other hand, we obtain a homotopy

$$\begin{aligned} [\phi_\square] &\rightsquigarrow [\text{id}_\gamma] \circ [\phi_\gamma] \rightsquigarrow [\text{id}_\gamma] \circ [\beta_\gamma^1] \circ [\text{log}] \circ [\phi_{\gamma+1}] \\ &\rightsquigarrow [\text{id}_\gamma] \circ [\text{log}] \circ [\phi_{\gamma+1}] \end{aligned}$$

by applying the homotopy  $\eta_{\square\gamma}$  of the *contact structure*  $\mathcal{H}_{\mathfrak{Qn}}$ , followed by the homotopies of the *telecore*  $\mathfrak{T}_{\mathfrak{Qn}}$ , followed by the homotopy  $\eta_\gamma$  of the *contact structure*  $\mathcal{H}_{\mathfrak{Qn}}$ . Thus, by applying the argument applied in the proof of the first incompatibility, we obtain *two mutually contradictory homotopies*  $[\lambda^\times] \circ [\phi_\square] \rightsquigarrow [\lambda^{\times\text{pf}}] \circ [\text{id}_{\gamma+1}] \circ [\phi_{\gamma+1}]$ . This completes the proof of the *second incompatibility* of assertion (iv).

Finally, we consider assertion (v). The *total  $\square$ -rigidity* in question follows immediately from Proposition 3.2, (iv) (cf. also the final portion of Proposition 3.2, (v)). The remainder of assertion (v) follows immediately from the definitions. This completes the proof of assertion (v).  $\square$

REMARK 3.6.1.

(i) The “output” of the “log-Frobenius observable”  $\mathfrak{S}_{\log}$  of Corollary 3.6, (iii), may be summarized *intuitively* in the following diagram:

$$\begin{array}{ccccccc}
 \dots & \Pi_{\Upsilon+1} & \xrightarrow{\sim} & \Pi_{\Upsilon+1} & \xrightarrow{\sim} & \Pi_{\Upsilon} & \xrightarrow{\sim} & \Pi_{\Upsilon} & & \\
 & \curvearrowright & & \curvearrowright & & \curvearrowright & & \curvearrowright & \dots & \\
 \dots & \bar{k}_{\Upsilon+1}^{\times} & \rightarrow & (\bar{k}_{\Upsilon+1}^{\times})^{\text{pf}} & \leftarrow & \bar{k}_{\Upsilon}^{\times} & \rightarrow & (\bar{k}_{\Upsilon}^{\times})^{\text{pf}} & & \\
 & & & & & \xrightarrow{\sim} & \Pi_{\Upsilon-1} & \xrightarrow{\sim} & \Pi_{\Upsilon-1} & \dots \\
 & & & & \dots & & \curvearrowright & & \curvearrowright & \\
 & & & & & \leftarrow & \bar{k}_{\Upsilon-1}^{\times} & \rightarrow & (\bar{k}_{\Upsilon-1}^{\times})^{\text{pf}} & \dots
 \end{array}$$

— where the arrows “ $\rightarrow$ ” are the natural morphisms (cf.  $\downarrow_{\times}$ !);  $\bar{k}_{\Upsilon}^{\times}$ , for  $\Upsilon \in L$ , is a copy of “ $\bar{k}^{\times}$ ” that arises, via  $\text{id}_{\Upsilon}$ , from the vertex  $\Upsilon$  of  $\mathcal{D}_{\leq 1}$ ; the arrows “ $\leftarrow$ ” are the inclusions arising from the fact that  $\bar{k}_{\Upsilon}^{\times}$  is obtained by applying the *log-Frobenius functor*  $\log$  to  $\bar{k}_{\Upsilon+1}^{\times}$  (cf.  $\downarrow_{\log, \Upsilon}$ !); the isomorphic “ $\Pi_{\Upsilon}$ ’s” that act on the various  $\bar{k}_{\Upsilon}^{\times}$ ’s and their perfections correspond to the *coricity* of  $\mathcal{E}$  (cf. Corollary 3.6, (i)). Finally, the *incompatibility* assertions of Corollary 3.6, (iv), may be thought of as a statement of the *non-existence* of some “*universal reference model*”

$$\bar{k}_{\text{model}}^{\times}$$

that maps *isomorphically* to the various  $\bar{k}_{\Upsilon}^{\times}$ ’s in a fashion that is *compatible* with the various arrows “ $\rightarrow$ ”, “ $\leftarrow$ ” of the above diagram — cf. also Corollary 3.7, (iv), below.

(ii) In words, the content of Corollary 3.6 may be summarized as follows (cf. the “*intuitive diagram*” of (i)):

- (a) The *Galois groups* that act on the various objects under consideration are *compatible* with *all* of the *operations* involved — in particular, the operations constituted by the functors  $\log$ ,  $\kappa_{\mathfrak{A}\mathfrak{n}}$ ,  $\phi_{\mathfrak{A}\mathfrak{n}}$  and the various related families of homotopies — cf. the *coricity* asserted in Corollary 3.6, (i).
- (b) By contrast, the operation constituted by the *log-Frobenius functor* (as “observed” via the *observable*  $\mathfrak{S}_{\log}$ ) is *not compatible*

ble with the *field structure* of the fields (i.e., “ $\bar{k}$ ”) involved (cf. Corollary 3.6, (iv)).

- (c) As a consequence of (a), the “*group-theoretic reconstruction*” of the base field via Corollary 1.10 is *compatible* with *all* of the operations involved, except “*momentarily*” when  $\log$  acts on the output of  $\phi_{\mathfrak{A}\mathfrak{n}}$  — an operation which “*temporarily obliterates*” the field structure of this output, although this field structure may be recovered by projecting back down to  $\mathcal{E}$  (cf. (a)) and applying  $\kappa_{\mathfrak{A}\mathfrak{n}}$ . This sort of “*conditional compatibility*” — i.e., up to a “*brief temporary exception*” — is expressed in the *telecoricity* asserted in Corollary 3.6, (ii).

In particular, if one thinks of the various operations involved as being “*software*” (cf. Remark 1.9.8), then the projection to  $\mathcal{E}$  — i.e., the operation of looking at the *Galois group* — is compatible with *simultaneous execution of all the “software”* (in particular, including  $\log$ !) under consideration; the “*group-theoreticity*” of the algorithms of Corollary 1.10 implies that  $\mathfrak{A}\mathfrak{n}\mathfrak{ab}$ ,  $\kappa_{\mathfrak{A}\mathfrak{n}}$  satisfy a similar “*compatibility with simultaneous execution of all software*” (cf. Remark 3.1.2) property.

REMARK 3.6.2.

(i) The reasoning that lies behind the name “*log-Frobenius functor*” may be understood as follows. At a very naive level, the natural logarithm may be thought of as a sort of “*raising to the  $\epsilon$ -th power*” (where  $\epsilon \rightarrow 0$  is some indefinite positive infinitesimal) — i.e., “ $\epsilon$ ” plays the role in characteristic  $(\epsilon \rightarrow)0$  of “ $p$ ” in characteristic  $p > 0$ . More generally, the logarithm frequently appears in the context of *Frobenius actions*, in particular in discussions involving *canonical coordinates*, such as in [Mzk1], Chapter III, §1.

(ii) In general, Frobenius morphisms may be thought of as “*compression morphisms*”. For instance, this phenomenon may be seen in the most basic example of a Frobenius morphism in characteristic  $p > 0$ , i.e., the morphism

$$t \mapsto t^p$$

on  $\mathbb{F}_p[t]$ . Put another way, the “*compression*” operation inherent in a Frobenius morphism may be thought of as an *approximation* of some sort of “*absolute constant object*” (such as  $\mathbb{F}_p$ ). In the context of the log-Frobenius

functor, this sort of compression phenomenon may be seen in the *pre-log-shells* defined in Definition 3.1, (iv), which will play a *key role* in the theory of §5 below.

(iii) Whereas the log-Frobenius functor *obliterates the field* (or ring) *structure* (cf. Remark 3.6.1, (ii), (b)) of the fields involved, the usual Frobenius morphism in positive characteristic is compatible with the ring structure of the rings involved. On the other hand, unlike generically smooth morphisms, the Frobenius morphism in positive characteristic has the effect of “*obliterating the differentials*” of the schemes involved.

REMARK 3.6.3. The diagram  $\mathcal{D}$  of Corollary 3.6 — cf., especially, the first two rows  $\mathcal{D}_{\leq 2}$  and the various *natural actions of  $\mathbb{Z}$*  discussed in Corollary 3.6, (v) — may be thought of as a sort of *combinatorial version of  $\mathbb{G}_m$*  — cf. the point of view of Remark 1.9.7.

REMARK 3.6.4. One verifies immediately that one may give a *tempered version* of Propositions 3.2, 3.3; Corollary 3.6 (cf. Remarks 1.9.1, 1.10.2).

REMARK 3.6.5. The notions of “core” and “telecore” are reminiscent of certain aspects of “*Hensel’s lemma*” (cf., e.g., [Mzk21], Lemma 2.1). That is to say, if one compares the *successive approximation operation* applied in the proof of Hensel’s lemma (cf., e.g., the proof of [Mzk21], Lemma 2.1) to the various *operations* (in the form of functors) that appear in a diagram of categories, then one is led to the following *analogy*:

$$\begin{aligned} \text{cores} &\longleftrightarrow \text{sets of solutions of “\acute{e}tale”, i.e., “slope zero” equations} \\ \text{telecores} &\longleftrightarrow \text{sets of solutions of “positive slope” equations} \end{aligned}$$

— i.e., where one thinks of applications of Hensel’s lemma in the context of *mixed characteristic*, so the property of being “\acute{e}tale in characteristic  $p > 0$ ” may be regarded as corresponding to “slope zero”. That is to say, the “\acute{e}tale case” of Hensel’s lemma is the easiest to understand. In this “\acute{e}tale case”, the *invertibility* of the Jacobian matrix involved implies that when one executes each successive approximation operation, the set of solutions *lifts uniquely*, i.e., “*transports isomorphically*” through the operation. This sort of “isomorphic transport” is reminiscent of the definition of a *core* on a diagram of categories. On the other hand, the “*positive slope case*” of Hensel’s lemma is a bit more complicated (cf., e.g., the proof of [Mzk21],

Lemma 2.1). That is to say, although the set of solutions does not quite “transport isomorphically” in the simplest most transparent fashion, the fact that the Jacobian matrix involved is *invertible up to a factor of  $p$*  implies that the set of solutions “*essentially transports isomorphically, up to a brief temporary lag*” — cf. the “*brief temporary exception*” of Remark 3.6.1, (ii), (c). Put another way, if one thinks in terms of *connections* on bases on which  $p$  is nilpotent, in which case *formal integration* takes the place of the “successive approximation operation” of Hensel’s lemma, then one has the following *analogy*:

$$\begin{aligned} \text{cores} &\longleftrightarrow \text{vanishing } p^n\text{-curvature} \\ \text{telecores} &\longleftrightarrow \text{nilpotent } p^n\text{-curvature} \end{aligned}$$

(where we refer to [Mzk4], Chapter II, §2; [Mzk7], §2.4, for more on “ $p^n$ -curvature”) — cf. Remark 3.7.2 below.

REMARK 3.6.6.

(i) In the context of the analogy between telecores and “positive slope situations” discussed in Remark 3.6.5, one question that may occur to some readers is the following:

What are the *values* of the positive slopes implicitly involved in a telecore?

At the time of writing, it appears to the author that, relative to this analogy, one should regard telecores as containing “*all positive slopes*”, or, alternatively, “*positive slopes of an indeterminate nature*”, which one may think of as corresponding to the *lengths* of the various paths emanating from the *core vertex* that one may travel along before descending back down to the core (cf. Remark 3.5.1). Indeed, from the point of view of the analogy (discussed in Remark 3.7.2 below) with the *uniformizing  $\mathcal{MF}^\nabla$ -objects* constructed in [Mzk1], [Mzk4], this is natural, since uniformizing  $\mathcal{MF}^\nabla$ -objects also involve, in effect, “all positive slopes”. Moreover, since telecores are of an “*abstract, combinatorial nature*” (cf. Remark 1.9.7) — i.e., not of a “*linear, module-theoretic nature*”, as is the case with  $\mathcal{MF}^\nabla$ -objects — it seems somewhat natural that this “*combinatorial non-linearity*” should interfere with any attempts to “separate out the various distinct positive slopes”, via, for instance, a “linear filtration”, as is often possible in the case of  $\mathcal{MF}^\nabla$ -objects.



(ii) From the point of view of the analogy with (uniformizing)  $\mathcal{MF}^\nabla$ -objects, one has the following (rough) correspondence:

$$\begin{aligned} \text{slope zero} &\longleftrightarrow \text{Frobenius “}\curvearrowright\text{” (an isomorphism)} \\ \text{positive slope} &\longleftrightarrow \text{Frobenius “}\curvearrowright\text{” } p^n \cdot \text{(an isomorphism)} \end{aligned}$$

(where “ $\curvearrowright$ ” is to be understood as shorthand for the phrase “acts via”;  $n$  is a *positive* integer). Perhaps the most fundamental example in the  $p$ -adic theory of such a (uniformizing)  $\mathcal{MF}^\nabla$ -object arises from the  $p$ -adic Galois representation obtained by extracting  $p$ -power roots of the standard unit  $U$  on the multiplicative group  $\mathbb{G}_m$  over  $\mathbb{Z}_p$ , in which case the “positive slope” involved corresponds to the action

$$d\log(U) = dU/U \mapsto p \cdot d\log(U)$$

induced by the Frobenius morphism  $U \mapsto U^p$ . In the situation of Corollary 3.6, an analogue of this sort of correspondence may be seen in the “temporary failure of coricity” (cf. Remark 3.6.1, (ii), (c); the *failure of coricity* documented in Corollary 3.6, (iv)) of the “mono-anabelian telecore” of Corollary 3.6, (ii). That is to say, *multiplication by a positive power of  $p$*  corresponds precisely to this “temporary failure of coricity”, a failure that is *remedied* (where the “remedy” corresponds to the *isomorphism* that appears by “peeling off” an appropriate power of  $p$ ) by projecting back down to  $\mathfrak{Anab}$ , an operation which (in light of the “group-theoretic nature” of the algorithms applied in  $\kappa\mathfrak{An}$ ) induces an *isomorphism* of, for instance, the base-field reconstructed *after* the application of  $\mathfrak{log}$  with the base-field that was reconstructed *prior* to the application of  $\mathfrak{log}$ .

REMARK 3.6.7. Note that in the situation of Corollary 3.6 (cf. also the terminology introduced in Definition 3.5), although we have formulated things in the language of *categories* and *functors*, in fact, the mathematical constructs in which we are ultimately interested have much *more elaborate structures* than categories and functors. That is to say:

In fact, what we are really interested in is not so much “categories” and “functors”, but rather “*types of data*” and “*operations*” (i.e., *algorithms!*) that convert some “*input type of data*” into some “*output type of data*”.

One aspect of this state of affairs may be seen in the fact that the crucial functors  $\mathbf{log}$ ,  $\kappa_{\mathfrak{A}nab}$  of Corollary 3.6 are *equivalences of categories* (which, moreover, are, in certain cases, *isomorphic to the identity functor!* — cf. Definition 3.1, (iv), (vi)) — i.e., from the point of view of the *purely category-theoretic structure* (cf., e.g., the point of view of [Mzk14], [Mzk16], [Mzk17]!) of “ $\mathcal{X}$ ”, “ $\mathcal{E}$ ”, or “ $\mathfrak{A}nab$ ”, these functors are “*not doing anything*”. On the other hand, from the point of view of “types of data” and “operations” on these “types of data” (cf. Remark 3.6.1), the operations constituted by the functors  $\mathbf{log}$ ,  $\kappa_{\mathfrak{A}nab}$  are *highly nontrivial*. To some extent, this state of affairs may be remedied by working with appropriate *observables* (i.e., which serve to project the operations constituted by functors between different categories down into arrows in a single category — cf. Remark 3.5.1), as in Corollary 3.6, (iii), (iv). Nevertheless, the use of observables does not constitute a fundamental solution to the issue raised above. It is the hope of the author to remedy this state of affairs in a more definitive fashion in a future paper by introducing appropriate “*enhancements*” to the usual theory of categories and functors.

To understand what is gained in Corollary 3.6 by the *mono-anabelian* theory of §1, it is useful to consider the following “*bi-anabelian analogue*” of Corollary 3.6.

**COROLLARY 3.7** (MLF-Galois-theoretic Bi-anabelian Log-Frobenius Incompatibility). *In the notation and conventions of Corollary 3.6, suppose, further, that  $\mathbb{T} = \mathbb{T}F$ . Consider the diagram of categories  $\mathcal{D}^\dagger$*

$$\begin{array}{ccccccc}
 \dots & \mathcal{X} \times_{\mathcal{E}} \mathcal{X} & \xrightarrow{\mathbf{log}_{\mathcal{X}}} & \mathcal{X} \times_{\mathcal{E}} \mathcal{X} & \xrightarrow{\mathbf{log}_{\mathcal{X}}} & \mathcal{X} \times_{\mathcal{E}} \mathcal{X} & \dots \\
 \dots & \text{pr}_{\gamma+1} \searrow & & \downarrow \text{pr}_{\gamma} & & \swarrow \text{pr}_{\gamma-1} & \dots \\
 & & & \mathcal{X} & & & \\
 & & & \lambda^{\times} \downarrow \quad \downarrow \lambda^{\times \text{pf}} & & & \\
 & & & \mathcal{N} & & & \\
 & & & \downarrow & & & \\
 & & & \mathcal{E} & & & 
 \end{array}$$

— where the second to fourth rows of  $\mathcal{D}^\dagger$  are identical to the second to

fourth rows of the diagram  $\mathcal{D}$  of Corollary 3.6;  $\mathcal{D}_{\leq 1}^\dagger$  is obtained by applying the “categorical fiber product”  $(-)\times_{\mathcal{E}}\mathcal{X}$  (cf. §0) to  $\mathcal{D}_{\leq 1}$ ;  $\text{pr}_\Upsilon$  denotes the projection to the first factor on the copy of  $\mathcal{X}\times_{\mathcal{E}}\mathcal{X}$  at the vertex  $\Upsilon\in L$ . Also, let us write

$$\pi_\Upsilon:\mathcal{X}\times_{\mathcal{E}}\mathcal{X}\rightarrow\mathcal{X}$$

for the projection to the second factor on the copy of  $\mathcal{X}\times_{\mathcal{E}}\mathcal{X}$  at the vertex  $\Upsilon\in L$ ,

$$\mathcal{D}^\dagger$$

for the result of appending these arrows  $\pi_\Upsilon$  to  $\mathcal{D}^\dagger$  — where we think of the codomain “ $\mathcal{X}$ ” of the arrows  $\pi_\Upsilon$  as a new “core” vertex lying in the first row of  $\mathcal{D}^\dagger$  “under” the various copies of “ $\mathcal{X}\times_{\mathcal{E}}\mathcal{X}$ ” at the vertices of  $L$  — and  $\mathcal{D}_{\leq n}^\dagger$  (where  $n\in\{1,2,3,4\}$ ) for the subdiagram of  $\mathcal{D}^\dagger$  constituted by  $\mathcal{D}_{\leq n}^\dagger$ , together with the newly appended arrows  $\pi_\Upsilon$ . Then:

(i)  $\mathcal{D}^\dagger = \mathcal{D}_{\leq 4}^\dagger$  (respectively,  $\mathcal{D}_{\leq 1}^\dagger$ ) admits a natural structure of core on  $\mathcal{D}_{\leq 3}^\dagger$  (respectively,  $\mathcal{D}_{\leq 1}^\dagger$ ). That is to say, loosely speaking,  $\mathcal{E}$  “forms a core” of the functors in  $\mathcal{D}^\dagger$ ; the “second factor”  $\mathcal{X}$  “forms a core” of the functors in  $\mathcal{D}_{\leq 1}^\dagger$ . (Thus, we think of the second factor of the various fiber product categories  $\mathcal{X}\times_{\mathcal{E}}\mathcal{X}$  as being a “universal reference model” — cf. Remark 3.7.3 below.)

(ii) Write

$$\delta_{\mathcal{X}}:\mathcal{X}\rightarrow\mathcal{X}\times_{\mathcal{E}}\mathcal{X}$$

for the natural diagonal functor and

$$\theta^{\text{bi}}:\text{pr}_1^{\text{bi}}\xrightarrow{\sim}\text{pr}_2^{\text{bi}}$$

for the isomorphism between the two projection functors  $\text{pr}_1^{\text{bi}}, \text{pr}_2^{\text{bi}}:\mathcal{X}\times_{\mathcal{E}}\mathcal{X}\rightarrow\mathcal{X}$  that arises from the functoriality — i.e., the bi-anabelian (or “Grothendieck Conjecture”-type) portion (cf. Remark 1.9.8) — of the “group-theoretic” algorithms of Corollary 1.10. Then  $\delta_{\mathcal{X}}$  is an equivalence of categories, a quasi-inverse for which is given by the projection to the second factor  $\pi_{\mathcal{X}}:\mathcal{X}\times_{\mathcal{E}}\mathcal{X}\rightarrow\mathcal{X}$ ;  $\theta^{\text{bi}}$  determines an isomorphism  $\theta_{\mathcal{X}}:\delta_{\mathcal{X}}\circ\pi_{\mathcal{X}}\xrightarrow{\sim}\text{id}_{\mathcal{X}\times_{\mathcal{E}}\mathcal{X}}$ . Moreover,  $\delta_{\mathcal{X}}$  gives rise to a telecore structure  $\mathfrak{T}_\delta$  on  $\mathcal{D}_{\leq 1}^\dagger$ , whose underlying diagram of categories we denote by  $\mathcal{D}_\delta^\dagger$ , by

appending to  $\mathcal{D}_{\leq 1}^\dagger$  telecore edges

$$\begin{array}{ccccccc}
 & & & \mathcal{X} & & & \\
 & & & \downarrow \delta_\gamma & & & \\
 \dots & \delta_{\gamma+1} \swarrow & & & \searrow \delta_{\gamma-1} & & \dots \\
 \dots & \mathcal{X} \times_{\mathcal{E}} \mathcal{X} & \xrightarrow{\log_{\mathcal{X}}} & \mathcal{X} \times_{\mathcal{E}} \mathcal{X} & \xrightarrow{\log_{\mathcal{X}}} & \mathcal{X} \times_{\mathcal{E}} \mathcal{X} & \dots
 \end{array}$$

from the core  $\mathcal{X}$  to the various copies of  $\mathcal{X} \times_{\mathcal{E}} \mathcal{X}$  in  $\mathcal{D}_{\leq 1}^\dagger$  given by copies of  $\delta_{\mathcal{X}}$ , which we denote by  $\delta_\gamma$ , for  $\gamma \in L$ . That is to say, loosely speaking,  $\delta_{\mathcal{X}}$  determines a telecore structure on  $\mathcal{D}_{\leq 1}^\dagger$ . Finally, let us write  $\mathcal{D}^*$  for the diagram of categories obtained by gluing (in the evident sense)  $\mathcal{D}_\delta^\dagger$  to  $\mathcal{D}^\dagger$  along  $\mathcal{D}_{\leq 1}^\dagger$  and then appending an edge

$$\mathcal{X} \xrightarrow{\delta_\square} \mathcal{X}$$

from the core vertex of  $\mathcal{D}_\delta^\dagger$  to the vertex at  $\square$  (i.e., the unique vertex of the second row of  $\mathcal{D}^\dagger$ ) given by a copy of the identity functor; for each  $\gamma \in L$ , let us write  $[\gamma_\gamma^0]$  for the path on  $\vec{\Gamma}_{\mathcal{D}^*}$  of length 0 at  $\gamma$  and  $[\gamma_\gamma^1]$  for the path on  $\vec{\Gamma}_{\mathcal{D}^*}$  of length 2 that starts from  $\gamma$ , descends via  $\pi_\gamma$  to the core vertex, and returns to  $\gamma$  via the telecore edge  $\delta_\gamma$ . Then the collection of natural transformations

$$\{\theta_{\square\gamma}, \theta_{\square\gamma}^{-1}, \theta_\gamma, \theta_\gamma^{-1}\}_{\gamma \in L}$$

— where we write  $\theta_{\square\gamma}$  for the identity natural transformation from the arrow  $\delta_\square : \mathcal{X} \rightarrow \mathcal{X}$  to the composite arrow  $\text{pr}_\gamma \circ \delta_\gamma : \mathcal{X} \rightarrow \mathcal{X}$  and

$$\theta_\gamma : \mathcal{D}_{[\gamma_\gamma^1]}^* \xrightarrow{\sim} \mathcal{D}_{[\gamma_\gamma^0]}^*$$

for the isomorphism arising from  $\theta_{\mathcal{X}}$  — generate a family of homotopies  $\mathcal{H}_\delta$  on  $\mathcal{D}^*$  (hence, in particular, by restriction, a contact structure on the telecore  $\mathfrak{T}_\delta$ ). Finally,  $\mathcal{D}^* = \mathcal{D}_{\leq 4}^*$  admits a natural structure of core on  $\mathcal{D}_{\leq 3}^*$  in a fashion compatible with the core structure of  $\mathcal{D}_{\leq 4}^\dagger$  on  $\mathcal{D}_{\leq 3}^\dagger$  discussed in (i) (that is to say, loosely speaking,  $\mathcal{E}$  “forms a core” of the functors in  $\mathcal{D}^*$ ).

(iii) Write

$$\underline{\log}_{\gamma} : \lambda^\times \circ \text{pr}_\gamma \circ \log_{\mathcal{X}} \rightarrow \lambda^{\times \text{pf}} \circ \text{pr}_{\gamma+1}, \quad \underline{\log}_x \stackrel{\text{def}}{=} \underline{\log}_x : \lambda^\times \rightarrow \lambda^{\times \text{pf}}$$

for the natural transformations determined by the natural transformations of Corollary 3.6, (iii). Then these natural transformations  $\underline{\mathcal{L}}_{\log, \gamma}, \underline{\mathcal{L}}_{\times}$  belong to a family of homotopies on  $\mathcal{D}_{\leq 3}^{\dagger}$  that determines on  $\mathcal{D}_{\leq 3}^{\dagger}$  a structure of observable  $\mathfrak{S}_{\log}^{\dagger}$  on  $\mathcal{D}_{\leq 2}^{\dagger}$  and, moreover, is compatible with the families of homotopies that constitute the core and telecore structures of (i), (ii).

(iv) The diagram of categories  $\mathcal{D}_{\leq 2}^{\dagger}$  does not admit a structure of core on  $\mathcal{D}_{\leq 1}^{\dagger}$  which (i.e., whose constituent family of homotopies) is compatible with (the constituent family of homotopies of) the observable  $\mathfrak{S}_{\log}^{\dagger}$  of (iii). Moreover, the telecore structure  $\mathfrak{T}_{\delta}$  of (ii), the family of homotopies  $\mathcal{H}_{\delta}$  of (ii), and the observable  $\mathfrak{S}_{\log}^{\dagger}$  of (iii) are not simultaneously compatible.

(v) The vertex  $\square$  of the second row of  $\mathcal{D}^*$  is a nexus of  $\vec{\Gamma}_{\mathcal{D}^*}$ . Moreover,  $\mathcal{D}^*$  is totally  $\square$ -rigid, and the natural action of  $\mathbb{Z}$  on the infinite linear oriented graph  $\vec{\Gamma}_{\mathcal{D}_{\leq 1}^{\dagger}}$  extends to an action of  $\mathbb{Z}$  on  $\mathcal{D}^*$  by nexus-classes of self-equivalences of  $\mathcal{D}^*$ . Finally, the self-equivalences in these nexus-classes are compatible with  $\mathcal{H}_{\delta}$  (cf. (ii)), as well as with the families of homotopies that constitute the cores, telecore, and observable of (i), (ii), (iii).

PROOF. The proofs of the various assertions of the present Corollary 3.7 are *entirely similar* to the proofs of the corresponding assertions of Corollary 3.6.  $\square$

REMARK 3.7.1. In some sense, the purpose of Corollary 3.7 is to examine what happens if the *mono-anabelian* theory of §1 is not available, i.e., if one is in a situation in which one may only apply the *bi-anabelian* version of this theory. This is the main reason for our assumption that “ $\mathbb{T} = \mathbb{TF}$ ” in Corollary 3.7 — that is to say, when  $\mathbb{T} = \mathbb{TM}$ , one is obliged to apply Proposition 3.2, (v), a result whose proof requires one to invoke the *mono-anabelian* theory of §1.

REMARK 3.7.2. The “*Frobenius-theoretic*” point of view of Remarks 3.6.2, 3.6.5, 3.6.6 motivates the following observation:

The situation under consideration in Corollaries 3.6, 3.7 is *structurally reminiscent* of the situation encountered in the *p-adic crystalline theory*, for instance, when one considers the  $\mathcal{MF}^{\nabla}$ -objects of [Falt].

That is to say, the *core*  $\mathcal{E}$  plays the role of the “*absolute constants*”, given, for instance, in the  $p$ -adic theory by (*absolutely*) *unramified extensions* of  $\mathbb{Z}_p$ . The isomorphism

$$\theta^{\text{bi}} : \text{pr}_1^{\text{bi}} \xrightarrow{\sim} \text{pr}_2^{\text{bi}}$$

(cf. Corollary 3.7, (ii)) between the *two projection functors*  $\text{pr}_1^{\text{bi}}, \text{pr}_2^{\text{bi}} : \mathcal{X} \times_{\mathcal{E}} \mathcal{X} \rightarrow \mathcal{X}$  is *formally reminiscent* of the notion of  $\mathfrak{a}(n)$  (integrable) *connection* in the crystalline theory. The *diagonal functor*

$$\delta_{\mathcal{X}} : \mathcal{X} \rightarrow \mathcal{X} \times_{\mathcal{E}} \mathcal{X}$$

(cf. Corollary 3.7, (ii)) is *formally reminiscent* of the diagonal embedding into the divided power envelope of the product of a scheme with itself in the crystalline theory. Moreover, since, in the crystalline theory, this divided power envelope may itself be regarded as a *crystal*, the (various divided powers of the ideal defining the) diagonal embedding may then be regarded as a sort of *Hodge filtration* on this crystal. That is to say, the *telecore* structure of Corollary 3.7, (ii), may be regarded as corresponding to the *Hodge filtration*, or, for instance, in the context of the theory of *indigenous bundles* (cf., e.g., [Mzk1], [Mzk4]), to the *Hodge section*. Thus, from this point of view, the second *incompatibility* of assertion (iv) of Corollaries 3.6, 3.7, is reminiscent of the fact that (in general) the *Frobenius action* on the crystal underlying an  $\mathcal{MF}^{\nabla}$ -object *fails* to preserve the *Hodge filtration*. For instance, in the case of indigenous bundles, this failure to preserve the Hodge section may be regarded as a consequence of the *isomorphism of the Kodaira-Spencer morphism* associated to the Hodge section. On the other hand, the *log-Frobenius-compatibility* of the *mono-anabelian models* discussed in Corollary 3.6 may be regarded as corresponding to *canonical Frobenius actions* on the crystals constituted by the divided power envelopes discussed above — cf. the *uniformizing  $\mathcal{MF}^{\nabla}$ -objects* constructed in [Mzk1], [Mzk4]. Moreover, the *compatibility* of the coricity of  $\mathcal{E}, \mathfrak{A}\mathfrak{n}\mathfrak{a}\mathfrak{b}$  with the *telecore* and *contact* structures of Corollary 3.6, (ii), on the one hand, and the “*log-Frobenius observable*”  $\mathfrak{S}_{\log}$  of Corollary 3.6, (iii), on the other hand, is reminiscent of the construction of the *Galois representation* associated to an  $\mathcal{MF}^{\nabla}$ -object by considering the submodule that lies in the 0-th step of the *Hodge filtration* and, moreover, is *fixed by the action of Frobenius* (cf. Remark 3.7.3, (ii), below). Thus, in summary, we have the following

“dictionary”:

the *coricity* of  $\mathcal{E}$   $\longleftrightarrow$  *absolutely unramified constants*  
*bi-anabelian* isomorphism of projection functors  
 $\longleftrightarrow$  *integrable connections*  
*diagonal functor*  $\delta_{\mathcal{X}}$  telecore str.  $\longleftrightarrow$  *Hodge filtration/section*  
*bi-anabelian log-incompatibility*  $\longleftrightarrow$  *Kodaira-Spencer isomorphism*  
*“forgetful” functor*  $\phi_{\mathfrak{A}_n}$  telecore str.  
 $\longleftrightarrow$  *underlying vector bundle* of  $\mathcal{MF}^{\nabla}$ -object  
*mono-anabelian log-compatibility*  
 $\longleftrightarrow$  (positive slope!) *uniformizing*  $\mathcal{MF}^{\nabla}$ -objects

(where “str.” stands for “structure”). This analogy with  $\mathcal{MF}^{\nabla}$ -objects will be developed further in §5 below.

REMARK 3.7.3. The significance of Corollary 3.7 in the context of our discussion of the *mono-anabelian* versus the *bi-anabelian* approach to anabelian geometry (cf. Remark 1.9.8) may be understood as follows.

(i) We begin by considering the *conditions* that we wish to impose on the framework in which we are to work. First of all, we wish to have some sort of *fixed reference model* of “ $\mathcal{X}$ ”. The fact that this model is to be *fixed* throughout the discussion then translates into the requirement that this copy of  $\mathcal{X}$  be a *core*, relative to the various “*operations*” performed during the discussion. On the other hand, one does not wish for this model to remain “completely unrelated to the operations of interest”, but rather that it may be *related*, or *compared*, to the various *copies of this model* that appear as one executes the operations of interest. In our situation, we wish to be able to relate the “fixed reference model” to the *copies of this model* — i.e., “*log-subject copies*” — that are *subject to the log-Frobenius operation* (i.e., functor — cf. Remark 3.6.7). Moreover, since the log-Frobenius functor is isomorphic to the identity functor (cf. Proposition 3.2, (v)), hence may only be “properly understood” in the context of the natural transformations “ $\iota_{\times}$ ” and “ $\iota_{\log}$ ”, we wish for everything that we do to be *compatible* with the operation of “*making an observation*” via these natural transformations. Thus, in summary, the *main conditions* that we wish to impose on the framework in which we are to work are the following:

- (a) *coricity* of the model;
- (b) *comparability* of the model to *log-subject copies* of the model;
- (c) *consistent observability* of the various operations executed (especially  $\mathbf{log}$ ).

In the context of the various assertions of Corollaries 3.6, 3.7, these three aspects correspond as follows:

- (a)  $\longleftrightarrow$  the *coricity* of (i), the “coricity portion” of the telecore structure of (ii),
- (b)  $\longleftrightarrow$  the *telecore* and *contact* structures/families of homotopies of (ii),
- (c)  $\longleftrightarrow$  the “ $\mathbf{log}$ -observable” of (iii).

(Here, we refer to the content of Definition 3.5, (iv), (b), as the “coricity portion” of a telecore structure.) In the case of Corollary 3.7, the “*fixed reference model*” is realized by applying a “*category-theoretic base-change*”  $(-)\times_{\mathcal{E}}\mathcal{X}$ , as in Corollary 3.7, i.e., the copy of “ $\mathcal{X}$ ” used to effect this base-change serves as the “fixed reference model”; in the case of Corollary 3.6, the “*fixed reference model*” is given by “ $\mathfrak{Anab}$ ” (i.e., especially, the *second* piece of parenthesized data “ $(-, -)$ ” in the definition of  $\mathfrak{Anab}$  — cf. Definition 3.1, (vi)). Also, we observe that the *second incompatibility* of assertion (iv) of Corollaries 3.6, 3.7 asserts, in effect, that *neither* of the approaches of these two corollaries succeeds in *simultaneously realizing* conditions (a), (b), (c), in the *strict sense*.

(ii) Let us take a closer look at the *mono-abelian* approach of Corollary 3.6 from the point of view of the discussion of (i). From the point of view of “*operations performed*”, this approach may be summarized as follows: One starts with “ $\mathbb{I}$ ”, applies the *mono-abelian* algorithms of Corollary 1.10 to obtain an object of  $\mathfrak{Anab}$ , then *forgets* the “*group-theoretic origins*” of such objects to obtain an object of  $\mathcal{X}$  (cf. the *telecore structure* of Corollary 3.6, (ii)), which is *subject* to the action of  $\mathbf{log}$ ; this action of  $\mathbf{log}$  *obliterates the ring structure* (indeed, it obliterates both the additive and multiplicative structures!) of the arithmetic data involved, hence leaving behind, as an *invariant of  $\mathbf{log}$* , only the original “ $\mathbb{I}$ ”, to which one may again apply the



mono-anabelian algorithms of Corollary 1.10.

$$\Pi \rightsquigarrow \begin{pmatrix} \Pi \\ \curvearrowright \\ \overline{k}_{\mathfrak{Qn}}^\times \end{pmatrix} \rightsquigarrow \begin{pmatrix} \Pi & & \\ \curvearrowright & & \\ \overline{k}_\gamma^\times & \curvearrowright & \mathfrak{log} \end{pmatrix} \rightsquigarrow \Pi \rightsquigarrow \begin{pmatrix} \Pi \\ \curvearrowright \\ \overline{k}_{\mathfrak{Qn}}^\times \end{pmatrix}$$

The point of the mono-anabelian approach is that although  $\mathfrak{log}$  obliterates the ring structures involved (cf. the second incompatibility of Corollary 3.6, (iv)),  $\mathcal{E}$  — i.e., “ $\Pi$ ” — remains *constant* (up to isomorphism) throughout the application of the various operations; this implies that the “*purely group-theoretic constructions*” of Corollary 1.10 — i.e.,  $\mathfrak{Anab}$ ,  $\kappa_{\mathfrak{Qn}}$  — also remain *constant* throughout the application of the various operations. In particular, in the above diagram, despite the fact that  $\mathfrak{log}$  obliterates the ring structure of “ $\overline{k}_\gamma^\times$ ”, the operations executed induce an *isomorphism* between all the “ $\Pi$ ’s” that appear, hence an *isomorphism* between the *initial* and *final* “ $(\Pi \curvearrowright \overline{k}_{\mathfrak{Qn}}^\times)$ ’s”. At a more technical level, this state of affairs may be witnessed in the fact that although (cf. the proof of the second incompatibility of Corollary 3.6, (iv)) there exist *incompatible composites of homotopies* involving the families of homotopies that constitute the telecore, contact, and observable structures involved, these composites *become compatible* as soon as one augments the various paths involved with a path back down to the *core vertex* “ $\mathfrak{Anab}$ ”. At a more philosophical level:

This state of affairs, in which the application of  $\mathfrak{log}$  does not immediately yield an isomorphism of “ $\overline{k}^\times$ ’s”, but does after “*peeling off the operation of forgetting the group-theoretic construction of  $\overline{k}_{\mathfrak{Qn}}^\times$* ”, is reminiscent of the situation discussed in Remark 3.6.6, (ii), concerning

$$\text{“Frobenius } \curvearrowright p^n \cdot \text{(an isomorphism)”}$$

(i.e., where Frobenius induces an isomorphism after “*peeling off*” an appropriate power of  $p$ ).

(iii) By contrast, the *bi-anabelian* approach of Corollary 3.7 may be understood in the context of the present discussion as follows: One starts with an *arbitrarily declared “model”* copy “ $\Pi \curvearrowright \overline{k}_{\text{model}}^\times$ ” of  $\mathcal{X}$ , then *forgets* the fact that this copy was arbitrarily declared a model (cf. the *telecore*

structure of Corollary 3.7, (ii)); this yields a copy “ $\Pi \curvearrowright \bar{k}_\gamma^\times$ ” of  $\mathcal{X}$  on which  $\mathbf{log}$  acts in a fashion that *obliterates the ring structure* of the arithmetic data involved, hence leaving behind, as an *invariant of  $\mathbf{log}$* , only the original “ $\Pi$ ”.

$$\left( \begin{array}{c} \Pi \\ \curvearrowright \\ \bar{k}_{\text{model}}^\times \end{array} \right) \rightsquigarrow \left( \begin{array}{ccc} \Pi & & \\ \curvearrowright & & \\ \bar{k}_\gamma^\times & \curvearrowright & \mathbf{log} \end{array} \right) \rightsquigarrow \Pi$$

Thus, unlike the case with the mono-anabelian approach, if one tries to work with another *model* “ $\Pi \curvearrowright \bar{k}_{\text{model}}^\times$ ” after applying  $\mathbf{log}$ , then the “ $\bar{k}_{\text{model}}^\times$ ” portion of this *new model* cannot be related to the “ $\bar{k}_{\text{model}}^\times$ ” portion of the *original model* in a consistent fashion — i.e., such a relation is *obstructed* by  $\mathbf{log}$ , which *obliterates* the ring structure of  $\bar{k}_{\text{model}}^\times$ . Moreover, unlike the case with the mono-anabelian approach, there is “*no escape route*” in the bi-anabelian approach (i.e., which requires the use of *models*) from this situation given by taking a path back down to some core vertex (i.e., such as “ $\mathfrak{Anab}$ ”). Relative to the analogy with usual Frobenius actions (cf. Remark 3.6.6, (ii)), this situation is reminiscent of the Frobenius action on the *ideal defining the diagonal* of a divided power envelope

$$\mathcal{I} \subseteq \mathcal{O}_{S \times_S^{\text{PD}} S}$$

(where  $S$  is, say, smooth over  $\mathbb{F}_p$ ) — i.e., Frobenius simply maps  $\mathcal{I}$  to 0 in a fashion that does not allow one to “*recover, in an isomorphic fashion, by peeling off a power of  $p$* ”. (Indeed, the data necessary to “*peel off a power of  $p$* ” consists, in essence, of a *Frobenius lifting* — which is, in essence, equivalent to the datum of a *uniformizing  $\mathcal{MF}^\nabla$ -object* — cf. Remark 3.7.2; the theory of [Mzk1], [Mzk4].) In particular:

Although it is difficult to give a completely rigorous formulation of the question “bi-anabelian  $\xrightarrow{?}$  mono-anabelian” raised in Remark 1.9.8, the state of affairs discussed above strongly suggests a *negative answer* to this question.

(iv) The following questions constitute a useful *guide* to understanding better the gap that lies between the “*success of the mono-anabelian approach*” and the “*failure of the bi-anabelian approach*”, as documented in (i), (ii), (iii):

- (a) In what capacity — i.e., as what *type* of mathematical object (cf. Remark 3.6.7) — does one *transport* — i.e., “effect the *coricity* of” (cf. condition (a) of (i)) — the fixed reference model of “ $\bar{k}^\times$ ” down to “*future log-generations*” (i.e., smaller elements of  $L$ )?
- (b) On precisely what *type* of data (cf. Remark 3.6.7) does the *comparison* (cf. condition (b) of (i)) via telecore/contact structures depend?

That is to say, in the *mono-anabelian* approach, the answer to both questions is given by  $\mathcal{E}$  (i.e., “ $\Pi$ ”),  $\mathfrak{Anab}$ ; by contrast, in the *bi-anabelian* approach, the answer to (b) necessarily *requires the inclusion of the “model  $\bar{k}_{\text{model}}^\times$ ”* — a requirement that is *incompatible with the coricity* required by (a) (i.e., since  $\log$  obliterates the ring structure of  $\bar{k}_{\text{model}}^\times$ ).

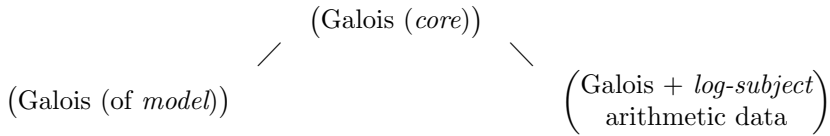

Fig. 1. *Mono-anabelian* comparison only requires “*Galois input data*”.

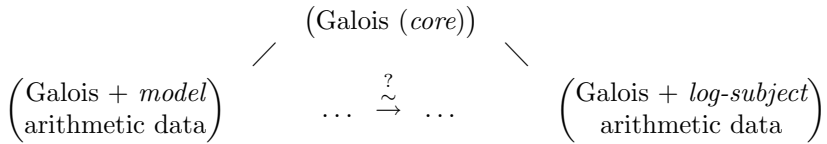

Fig. 2. *Bi-anabelian* comparison requires “*arithmetic input data*”.

One way to understand this state of affairs is as follows. If one attempts to construct a “*bi-anabelian version of  $\mathfrak{Anab}$* ”, then the requirement of *coricity* means that the “*model  $\bar{k}_{\text{model}}^\times$* ” employed in the *bi-anabelian reconstruction algorithm* of such a “*bi-anabelian version of  $\mathfrak{Anab}$* ” must be *compatible* with the various isomorphisms  $\bar{k}_{\text{model}}^\times \xrightarrow{\sim} \bar{k}_\gamma^\times$  of Remark 3.6.1, (i) — where we recall that the various distinct  $\bar{k}_\gamma^\times$ ’s are related to one another by  $\log$  — i.e.,

compatible with the “*building*”, or “*edifice*”, of  $\bar{k}_\gamma^\times$ ’s constituted by these isomorphisms together with the diagram of Remark 3.6.1, (i). That is to say, in order for the required coricity to hold, this bi-anabelian reconstruction algorithm must be such that it *only depends on the ring structure of  $\bar{k}_{\text{model}}^\times$  “up to  $\log$ ”* — i.e., the algorithm must be *immune to the confusion (arising from  $\log$ ) of the additive and multiplicative structures that constitute this ring structure*. On the other hand, the bi-anabelian approach to reconstruction clearly *does not satisfy this property* (i.e., it requires that the ring structure of  $\bar{k}_{\text{model}}^\times$  be *left intact*).

REMARK 3.7.4. In the context of the issue of *distinguishing* between the mono-anabelian and bi-anabelian approaches to anabelian geometry (cf. Remark 3.7.3), one question that is often posed is the following:

Why can’t one somehow *sneak* a “fixed reference model” into a “mono-anabelian reconstruction algorithm” by finding, for instance,

$$\text{some copy of } \mathbb{Q} \text{ or } \mathbb{Q}_p$$

inside the Galois group “ $\Pi$ ” and then building up some copy of the hyperbolic orbicurve under consideration over this base field (i.e., this copy of  $\mathbb{Q}$ ,  $\mathbb{Q}_p$ ), which one then takes as one’s “model”, thus allowing one to “*reduce*” *mono-anabelian problems to bi-anabelian ones* (cf. Remark 1.9.8)?

One important observation, relative to this question, is that although it is not so difficult to “construct” such copies of  $\mathbb{Q}$  or  $\mathbb{Q}_p$  from  $\Pi$ , it is substantially more difficult to

construct copies of the *algebraic closures* of  $\mathbb{Q}$  or  $\mathbb{Q}_p$  in such a way that the resulting *absolute Galois groups* are *isomorphic* to the appropriate quotient of the given Galois group “ $\Pi$ ” in a *functorial* fashion (cf. Remark 3.7.5 below).

Moreover, once one constructs, for instance, a universal pro-finite étale covering of an appropriate hyperbolic orbicurve on which  $\Pi$  acts (in a “natural”, functorial fashion), one must specify (cf. question (a) of Remark 3.7.3, (iv)) in what capacity — i.e., as what *type* of mathematical object — one *transports* (i.e., “effects the *coricity* of”) this pro-hyperbolic orbicurve

model down to “future log-generations”. Then if one only takes a *naive* approach to these issues, one is ultimately led to the arbitrary introduction of “models” that *fail to be immune to the application of the log-Frobenius functor* — that is to say, one finds oneself, in effect, in the situation of the “bi-anabelian approach” discussed in Remark 3.7.3. Thus, the above discussion may be summarized in flowchart form, as follows:

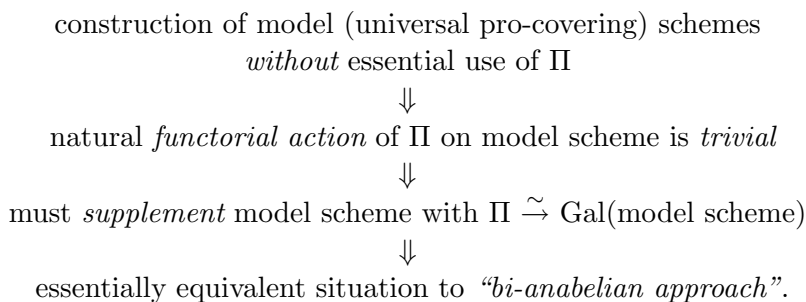

Put another way, if one tries to sneak a “fixed reference model” that may be constructed *without* essential use of “ $\Pi$ ” into a “mono-anabelian reconstruction algorithm”, then one finds oneself confronted with the following *two mutually exclusive choices* concerning the *type* of mathematical object (cf. question (a) of Remark 3.7.3, (iv)) that one is to assign to this model:

- (\*) the model *arises* from “ $\Pi$ ”  $\implies$  “*functorially trivial model*”;
- (\*\*) the model *does not arise* from “ $\Pi$ ”  $\implies$  “*bi-anabelian approach*”.

In particular, Figures 1 and 2 of Remark 3.7.3, (iv), are *not* (at least in an “a priori sense”) “*essentially equivalent*”.

REMARK 3.7.5.

(i) From the point of view of “*constructing models of the base field from  $\Pi$* ” (cf. the discussion of Remark 3.7.4), one natural approach to the issue of finding “*Galois-compatible models*” is to work with *Kummer classes* of scheme-theoretic functions, since Kummer classes are *tautologically compatible with Galois actions*. (Indeed, the use of Kummer classes is one important aspect of the theory of §1.) Moreover, in addition to being “tautologically Galois-compatible”, Kummer classes also have the virtue of fitting into a *container*

$$\mathcal{H}(\Pi) \stackrel{\text{def}}{=} H^1(\Pi, \mu_{\mathbb{Z}}(\Pi))$$

(cf. Corollary 1.10, (d), where we take “ $\Pi_X$ ” to be  $\Pi$ ) which *inherits the coricity of  $\Pi$*  (cf. question (a) of Remark 3.7.3, (iv)) in a very natural, tautological fashion. Thus, once one characterizes, in a “group-theoretic” fashion, the “Kummer subset” of this *container*  $\mathcal{H}(\Pi)$  (i.e., the subset constituted by the Kummer classes that arise from scheme-theoretic functions), it remains to reconstruct the *additive structure* on (the union with  $\{0\}$  of) the set of Kummer classes (cf. the theory of §1). If one takes the point of view of the question posed in Remark 3.7.4, then it is tempting to try to use “models” *solely* as a means to reconstruct this additive structure.

This approach, which combines the “*purely group-theoretic*” (i.e., “mono-anabelian”) *container*  $\mathcal{H}(\Pi)$  with the *indirect* use of “models” to reconstruct the additive structure (or the Kummer subset), may be thought of as a sort of *intermediate* alternative between the “mono-anabelian” and “bi-anabelian” approaches discussed so far; in the discussion to follow, we shall refer to this sort of intermediate approach as “*pseudo-mono-anabelian*”.

With regard to implementing this *pseudo-mono-anabelian* approach, we observe that the “*automorphism version of the Grothendieck Conjecture*” (i.e., the *functoriality* of the algorithms of Corollary 1.10, applied to *automorphisms*) allows one to conclude that the additive structure “pulled back from a model scheme via the Kummer map” is *rigid* (i.e., remains unaffected by automorphisms of  $\Pi$ ). On the other hand, the “*isomorphism version of the Grothendieck Conjecture*” (i.e., the *functoriality* of the algorithms of Corollary 1.10, applied to *isomorphisms* — cf. the isomorphism  $\theta^{\text{bi}}$  of Corollary 3.7, (ii)) allows one to conclude that this additive structure is *independent of the choice of model*.

(ii) The pseudo-mono-anabelian approach gives rise to a theory that satisfies many of the useful properties satisfied by the mono-anabelian theory. Thus, at first glance, it is tempting to consider simply *abandoning the mono-anabelian approach, in favor of the pseudo-mono-anabelian approach*. Closer inspection reveals, however, that the situation is not so simple. Indeed, relative to the *coricity* requirement of Remark 3.7.3, (i), (a), there is no problem with allowing the “*hidden models*” on which the pseudo-mono-anabelian approach depends in an essential way to *remain hidden*. On the other hand, the issue of *relating* (cf. Remark 3.7.3, (i), (b)) these hidden

models to *log-subject copies* of these models is more complicated. Here, the *central problem* may be summarized as follows (cf. Remark 3.7.3, (iv), (a), (b)):

*Problem* ( $\ast^{\text{type}}$ ): Find a *type* of mathematical object that (in the context of the framework discussed in Remark 3.7.3, (i)) serves as a *common type* of mathematical object for both “coric models” and “log-subject copies”, thus rendering possible the *comparison* of “coric models” and “log-subject copies”.

That is to say, in the *mono-anabelian* approach, this “common type” is furnished by the objects that constitute  $\mathcal{E}$  and (in light of the “*group-theoreticity*” of the algorithms of Corollary 1.10)  $\mathfrak{Anab}$ ; in the *bi-anabelian* approach, the “common object” is furnished by the “*copy of  $\mathcal{X}$  that appears in the base-change  $(-) \times_{\mathcal{E}} \mathcal{X}$* ”. Note that it is precisely the existence of this “common type of mathematical object” that renders possible the definition of the *telecore structure* — cf., especially, the functor  $\delta_{\mathcal{X}}$  of Corollary 3.7, (ii). In particular, we note that the definition of the *diagonal functor*  $\delta_{\mathcal{X}}$  is possible *precisely* because of the *equality* of the types of mathematical object involved in the two factors of  $\mathcal{X} \times_{\mathcal{E}} \mathcal{X}$ . On the other hand, if, in implementing the *pseudo-mono-anabelian* approach, one tries to use, for instance,  $\mathcal{E}$  (i.e., without including the “*hidden model*”!), then although this yields a framework in which it is possible to work with the “*mono-anabelian container*  $\mathcal{H}(\Pi)$ ”, this does not allow one to describe the *contents* (i.e., the Kummer subset with its ring structure) of this container. That is to say, if one describes these “contents” via “*hidden models*”, then the data contained in the “common type” is *not sufficient* for the operation of *relating* this description to the “*conventional description of contents*” that one wishes to apply to the *log-subject copies*. Indeed, if the coric models and log-subject copies *only share the container*  $\mathcal{H}(\Pi)$ , but *not the description of its contents* — i.e., the description for the coric models is some “*mysterious description involving hidden models*”, while the description for the log-subject copies is the “*standard Kummer map description*” — then, *a priori*, there is *no reason* that these two descriptions should *coincide*. For instance, if the “mysterious description” is not related to the “standard description” via some *common description* applied to a *common type* of mathematical object, then, *a priori*, the “mysterious description” could be (among a vast variety of possibilities) one of the following:

- (1) Instead of embedding the (nonzero elements of the) *base field* into  $\mathcal{H}(\Pi)$  via the usual Kummer map, one could consider the embedding obtained by composing the usual Kummer map with the automorphism induced by some automorphism of the quotient  $\Pi \rightarrow G_k$  (cf. the notation of Corollary 1.10, where we take “ $\Pi_X$ ” to be  $\Pi$ ) which is *not of scheme-theoretic origin* (cf., e.g., [NSW], the Closing Remark preceding Theorem 12.2.7).
- (2) Alternatively, instead of embedding the *function field* of the curve under consideration into  $\mathcal{H}(\Pi)$  via the usual Kummer map, one could consider the embedding obtained by composing the usual Kummer map with the automorphism of  $\mathcal{H}(\Pi)$  given by *multiplication by some element*  $\in \widehat{\mathbb{Z}}^\times$ .

Thus, in order to ensure that such pathologies do not arise, it appears that there is little choice but to *include the ring/scheme-theoretic models* in the *common type* that one adopts as a “*solution to* ( $\ast$ <sup>*type*</sup>)”, so that one may apply the “*standard Kummer map description*” in a *simultaneous, consistent* fashion to both the coric data and the log-subject data. But (since these models are “*functorially obstructed from being subsumed into*  $\Pi$ ” — cf. Remark 3.7.4) the inclusion of such ring/scheme-theoretic models amounts precisely to the “*bi-anabelian approach*” discussed in Remark 3.7.3 (cf., especially, Figure 2 of Remark 3.7.3, (iv)).

(iii) From a “*physical*” point of view, it is natural to think of data that satisfies some sort of *coricity* — such as the *étale* fundamental group  $\Pi$  — as being “*massless*”, like *light*. By comparison, the arithmetic data “ $\overline{k}^\times$ ” — on which the *log-Frobenius functor* acts non-isomorphically — may be thought of as being like *matter* which has “*weight*”. This dichotomy is reminiscent of the dichotomy discussed in the Introduction to [Mzk16] between “*étale-like*” and “*Frobenius-like*” structures. Thus, in summary:

$$\begin{aligned} \text{coricity, “étale-like” structures} &\longleftrightarrow \text{massless, like light} \\ \text{“Frobenius-like” structures} &\longleftrightarrow \text{matter of positive mass.} \end{aligned}$$

From this point of view, the discussion of (i), (ii) may be summarized as follows: Even if the *container*  $\mathcal{H}(\Pi)$  is *massless*, it one tries to use it to carry “*cargo of substantial weight*”, then the resulting package (of container plus cargo) is *no longer massless*. On the other hand, the very existence



of *mono-anabelian algorithms* as discussed in §1, §2 corresponds, in this analogy, to the “*conversion of light into matter*” (cf. the point of view of Remark 1.9.7)!

(iv) Relative to the dichotomy discussed in the Introduction to [Mzk16] between “*étale-like*” and “*Frobenius-like*” structures, the problem observed in the present paper with the *bi-anabelian* approach may be thought of as an example of the phenomenon of the *non-applicability of Galois* (i.e., “*étale-like*”) *descent with respect to “Frobenius-like” morphisms* (i.e., the existence of descent data for a “Frobenius-like” morphism which cannot be descended to an object on the codomain of the morphism). In classical arithmetic geometry, this phenomenon may be seen, for instance, in the non-descendability of Galois-invariant coherent ideals with respect to morphisms such as  $\text{Spec}(k[t]) \rightarrow \text{Spec}(k[t^n])$  (where  $n \geq 2$  is an integer;  $k$  is a field), or (cf. the discussion of “ $\mathcal{X} \times_{\mathcal{E}} \mathcal{X}$ ” in Remark 3.7.2) the difference between an *integrable connection* and an *integrable connection equipped with a compatible Frobenius action* (e.g., of the sort that arises from an  $\mathcal{MF}^{\nabla}$ -object).

REMARK 3.7.6. With regard to the *pseudo-mono-anabelian* approach discussed in Remark 3.7.5, one may make the following further observations.

(i) In order to carry out the *pseudo-mono-anabelian* approach (or, *a fortiori*, the *mono-anabelian* approach), it is necessary to use the full

*profinite étale fundamental group*

of a hyperbolic orbicurve, say, of strictly Belyi type. That is to say, if, for instance, one attempts to use the *geometrically pro- $\Sigma$*  fundamental group of a hyperbolic curve (i.e., where  $\Sigma$  is a set of primes which is not equal to the set of all primes), then the crucial *injectivity of the Kummer map* (cf. Proposition 1.6, (i)) *fails to hold*. In particular, this failure of injectivity means that one cannot work with the *crucial additive structure* on (the union with  $\{0\}$  of) the image of the Kummer map.

(ii) In a similar vein, if one attempts to work, for instance, with the *absolute Galois group of a number field* — i.e., in the *absence* of any geometric fundamental group of a hyperbolic orbicurve over the number field — then, in order to work with Kummer classes, one must contend with the

nontrivial issue of *finding an appropriate (profinite) cyclotome* (i.e., copy of “ $\widehat{\mathbb{Z}}(1)$ ”) to replace the “curve-based cyclotome  $M_X$ ” of Proposition 1.4, (ii) (cf. also Remark 1.9.5).

(iii) Next, we observe that if one attempts to *construct “models of the base field”* via the theory of “*characters of qLT-type*” as in [Mzk20], §3 (cf. also the theory of [Mzk2], §4), then although (just as was the case with *Kummer classes*) such “qLT-models of the base field” are *tautologically Galois-compatible* and *admit a coricity inherited from the coricity of  $\Pi$* , (unlike the case with *Kummer classes*) the essential use of *p-adic Hodge theory* implies that the resulting “*construction of the base field*” (cf. the discussion of Remark 1.9.5) is

*incompatible* with the operation of passing from *global* (e.g., number) fields to *local* fields

(i.e., does not admit an analogue of the first portion of Corollary 1.10, (h)), hence also *incompatible* with the operation of *relating* the resulting “constructions of the base field” at *different localizations* of a number field. Such localization (i.e., in the terminology of §5, “*panalocalization*”) properties will play a *key role* in the theory of §5 below.

(iv) In the context of (iii), it is interesting to note that *geometrically pro- $\Sigma$  fundamental groups* as in (i) also *fail to be compatible with localization*. Indeed, even if some sort of pro- $\Sigma$  analogue of the theory of §1 is, in the future, obtained for the primes lying over prime numbers  $\in \Sigma$ , such an analogue is *impossible* at the primes lying over prime numbers  $\notin \Sigma$  (since, as is easily verified, at such primes, the automorphisms of  $G_k$  (notation of Corollary 1.10) that are *not of scheme-theoretic origin* may extend, in general, to automorphisms of the *full arithmetic* (geometrically pro- $\Sigma$ ) *fundamental group*).

(v) At the time of writing, it appears to be rather difficult to give a *mono-anabelian “group-theoretic” algorithm* as in Theorem 1.9 in the case of *number fields* by somehow “gluing together” (mono-anabelian, “group-theoretic”) algorithms (cf. the approach via *p-adic Hodge theory* discussed in (iii)) applied at *nonarchimedean completions* of the number field. That is to say, if one tries, for instance, to construct a *number field  $F$*  as a subset of the product of copies of  $F$  constructed at various nonarchimedean completions of  $F$ , then it appears to be a *highly nontrivial* issue to reconstruct

the correspondences between the various “local copies” of  $F$ . Indeed, if one attempts to work with *abelianizations* of local and global Galois groups and apply *class field theory* (i.e., in the fashion of [Uchi], in the case of *function fields*), then one may only recover the “global copy” of  $F^\times$  embedded in the idèles up to an indeterminacy that involves, in particular, various “solenoids” (cf., e.g., [ArTt], Chapter Nine, Theorem 3). On the other hand, if one attempts to work with local and global *Kummer classes*, then one must contend with the phenomenon that it is not clear how to *lift* local Kummer classes to global Kummer classes; that is to say, the indeterminacies that occur for such liftings are of a nature roughly reminiscent of the global Kummer classes whose vanishing is implied by the so-called *Leopoldt Conjecture* (i.e., in its formulation concerning  $p$ -adic localizations of units of a number field), which is unknown in general at the time of writing.

REMARK 3.7.7.

(i) One way to interpret the fact that the log-Frobenius operation  $\mathbf{log}$  is *not a ring homomorphism* (cf. the discussion of Remarks 3.7.3, 3.7.4, 3.7.5) is to think of “ $\mathbf{log}$ ” as constituting a sort of “*wall*” that separates the *two “distinct scheme theories”* that occur *before* and *after* its application. The étale fundamental groups that arise in these “distinct scheme theories” thus necessarily correspond to *distinct, unrelated basepoints*. Thus, if, for  $i = 1, 2$ ,  $G_i \overset{\text{out}}{\curvearrowright} \Delta_i$  is a copy of the outer Galois action on the geometric fundamental group “ $G_k \overset{\text{out}}{\curvearrowright} \Delta_X$ ” of Theorem 1.9 that arises in one of these two “distinct scheme theories” separated by the “ $\mathbf{log}$ -wall”, then although this  $\mathbf{log}$ -wall *cannot be penetrated by ring structures* (i.e., by “scheme theory”), it *can be penetrated* by the *abstract profinite group structure* of the  $G_i$  — cf. the *Galois-equivariance* of the map “ $\mathbf{log}_k^-$ ” of Definition 3.1, (i). Moreover, since the “abstract outer action pair” (i.e., an abstract profinite group equipped with an outer action by another abstract profinite group)  $G_2 \overset{\text{out}}{\curvearrowright} \Delta_2$  is clearly *isomorphic* to the composite abstract outer action pair  $G_1 \overset{\sim}{\curvearrowright} G_2 \overset{\text{out}}{\curvearrowright} \Delta_2$  (as well as, by definition, the abstract outer action pair  $G_1 \overset{\text{out}}{\curvearrowright} \Delta_1$ ) — i.e.,

$$\left( G_1 \overset{\text{out}}{\curvearrowright} \Delta_1 \right) \overset{\sim}{\curvearrowright} \left( G_1 \overset{\sim}{\curvearrowright} G_2 \overset{\text{out}}{\curvearrowright} \Delta_2 \right) \overset{\sim}{\curvearrowright} \left( G_2 \overset{\text{out}}{\curvearrowright} \Delta_2 \right)$$

— we thus conclude that the  $\mathbf{log}$ -wall *can be penetrated by the isomorphism*

class of the abstract outer action pair  $G_i \overset{\text{out}}{\curvearrowright} \Delta_i$ .

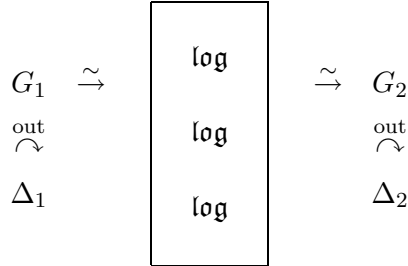

(ii) Once one has made the observations made in (i), it is natural to proceed to consider what sort of “additional data” may be *shared on both sides* of the **log**-wall. Typically, “purely group-theoretic structures” constructed from “ $G_i \overset{\text{out}}{\curvearrowright} \Delta_i$ ” serve as *natural containers* for such additional data (cf., e.g., the discussion of Remark 3.7.5). Thus, the additional data may be thought as some sort of a *choice* (cf. the dotted arrows in the diagram below) among *various possibilities* (cf. the “ $\circ$ ’s” in the diagram below) housed in such a group-theoretic container.

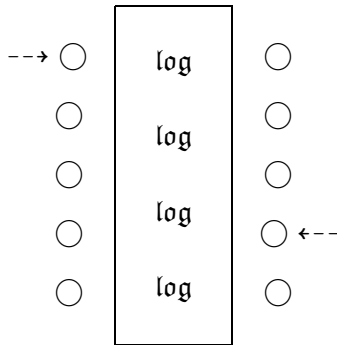

From this point of view:

The fundamental difference that distinguishes the *pseudo-mono-anabelian* approach discussed in Remark 3.7.5 from the *mono-anabelian* approach is the issue of whether this “choice” is specified in terms that *depend on the scheme theory* that gives rise to the choice (i.e., the pseudo-mono-anabelian case) or not (i.e., the mono-anabelian case, in which the choice may be specified

in language that depends only on the *abstract group structure* of, say, “ $G_i \overset{\text{out}}{\curvearrowright} \Delta_i$ ”).

In fact, the discussion in Remark 3.7.5, (ii) (cf. also Figs. 1, 2 of Remark 3.7.3, (iv)), may be depicted via a similar illustration to the above illustration of the “**log**-wall” in which the “**log**-wall” is replaced by a “*model-wall*” separating “*reference models*” from “*log-subject copies*” of such models. In Remark 3.7.5, (ii), special attention was given to the situation in which the “additional data” consists of the “*additive structure*” on the image of the Kummer map. When the  $\Delta_i$ ’s of (i) are given by the *birational geometric fundamental groups* “ $\Delta_{\eta_X}$ ” of Theorem 1.11, another example of such “additional data” in which *the specification of the “choice” depends on “scheme theory”* (and hence cannot, at least *a priori*, be shared on both sides of the **log**-wall) is given by the *specification of some finite collection of closed points* corresponding to the cusps of some *affine hyperbolic curve* that lies in *some given scheme theory* (cf. Remark 1.11.5).

(iii) With regard to the issue of “specifying some finite collection of closed points corresponding to the cusps of an affine hyperbolic curve” discussed in the final portion of (ii), we note that in certain *special cases*, a “purely group-theoretic” specification is in fact possible. For instance, if, in the notation of Theorem 1.11,  $X$  is a *hyperelliptic curve* whose *unique non-trivial  $k$ -automorphism* is given by its hyperelliptic involution, then the *set of points fixed by the hyperelliptic involution* constitutes such an example in which a “purely group-theoretic” specification can be made by considering the conjugacy classes of inertia groups “ $I_x$ ” fixed by the unique nontrivial outer automorphism of  $\Delta_{\eta_X}$  that commutes with the given outer action of  $G_k$  on  $\Delta_{\eta_X}$ .

(iv) The “**log**-wall” discussed in (i) is reminiscent of the *constant indeterminacy* arising from *morphisms of Frobenius type* (i.e., which thus constitute a “wall” that cannot be penetrated by *constant rigidity*) in the theory of the *étale theta function* (cf. [Mzk18], Corollary 5.12 and the following remarks), as well as of the subtleties that arise from the *Frobenius morphism* in the context of *anabelian geometry in positive characteristic* (cf., e.g., [Stix]).

REMARK 3.7.8.

Many of the arguments in the various remarks following Corollaries 3.6, 3.7 are not formulated entirely rigorously. Thus, in the future, it is quite

possible that certain of the obstacles pointed out in these remarks can be overcome. Nevertheless, we presented these remarks in the hope that they could aid in elucidating the content of and motivation (from the point of view of the author) behind the various rigorously formulated results of the present paper.

**Section 4. Archimedean Log-Frobenius Compatibility**

In the present §4, we present an *archimedean* version (cf. Corollary 4.5) of the theory of §3, i.e., we interpret the theory of §2 in terms of a certain *compatibility* with the “*log-Frobenius functor*”.

DEFINITION 4.1.

(i) Let  $k$  be a *CAF* (cf. §0). Write  $\mathcal{O}_k \subseteq k$  for the *subset of elements of absolute value  $\leq 1$* ,  $\mathcal{O}_k^\times \subseteq \mathcal{O}_k$  for the *subgroup of units* (i.e., elements of absolute value equal to 1 — cf. [Mzk17], Definition 3.1, (ii)),  $\mathcal{O}_k^> \subseteq \mathcal{O}_k$  for the *multiplicative monoid of nonzero elements*, and  $k^\sim \rightarrow k^\times \stackrel{\text{def}}{=} k \setminus \{0\}$  for the *universal covering of  $k^\times$* . Thus,  $k^\sim \rightarrow k^\times$  is *uniquely determined*, up to *unique isomorphism*, as a *pointed topological space* and, moreover, (as is well-known) may be constructed *explicitly* by considering *homotopy classes of paths* on  $k^\times$ ; moreover, the pointed topological space  $k^\sim$  admits a *natural topological group structure*, determined by the topological group structure of  $k^\times$ . Note that the “inverse” of the *exponential map*  $k \rightarrow k^\times$  (given by the usual power series) determines an *isomorphism of topological groups*

$$\log_k : k^\sim \xrightarrow{\sim} k$$

— which we shall refer to as the *logarithm* associated to  $k$ . Next, let

$$\mathbb{X}_{\text{ell}}$$

be an *elliptically admissible Aut-holomorphic orbispace* (cf. Definition 2.1, (i); Remark 2.1.1). We shall refer to as a *(k-)Kummer structure* on  $\mathbb{X}_{\text{ell}}$  any *isomorphism of topological fields*

$$\kappa_k : k \xrightarrow{\sim} \overline{\mathcal{A}}_{\mathbb{X}_{\text{ell}}} \stackrel{\text{def}}{=} \mathcal{A}_{\mathbb{X}_{\text{ell}}} \cup \{0\}$$

— where we write  $\mathcal{A}_{\mathbb{X}_{\text{ell}}}$  for the “ $\mathcal{A}_p$ ” of Corollary 2.7, (e) (equipped with various topological and algebraic structures), which may be *identified* (hence

considered as an object that is *independent* of “ $p$ ”) via the various isomorphisms “ $\mathcal{A}_p \xrightarrow{\sim} \mathcal{A}_{p'}$ ” of Corollary 2.7, (e), together with the *functoriality* of the algorithms of Corollary 2.7. Note that  $k$ ,  $k^\times$ ,  $k^\sim$ , and  $\overline{\mathcal{A}}_{\mathbb{X}_{\text{ell}}}$  are equipped with *natural Aut-holomorphic structures*, with respect to which  $\kappa_k$  determines *co-holomorphicizations* between  $k$  and  $\overline{\mathcal{A}}_{\mathbb{X}_{\text{ell}}}$ , as well as between  $k^\sim$  and  $\overline{\mathcal{A}}_{\mathbb{X}_{\text{ell}}}$ ; moreover, these co-holomorphicizations are *compatible* with  $\log_k$ . Next, let

$$\mathbb{T} \in \{\text{TF}, \text{TCG}, \text{TLG}, \text{TM}, \text{TH}, \text{TH}\boxplus\}$$

— where TF, TCG, TLG, TM as in Definition 3.1, (i), and we write

$$\text{TH}$$

for the category of *connected Aut-holomorphic orbispaces* and morphisms of Aut-holomorphic orbispaces (cf. Remark 2.1.1), and

$$\text{TH}\boxplus$$

for the category of *connected Aut-holomorphic groups* (i.e., Aut-holomorphic spaces equipped with a topological group structure such that both the Aut-holomorphic and topological group structures arise from a single connected complex Lie group structure) and homomorphisms of Aut-holomorphic groups. If  $\mathbb{T}$  is equal to TF (respectively, TCG; TLG; TM; TH; TH $\boxplus$ ), then let  $M_k \in \text{Ob}(\mathbb{T})$  be the object determined by  $k$  (respectively, the object determined by  $\mathcal{O}_k^\times$ ; the object determined by  $k^\times$ ; the object determined by  $\mathcal{O}_k^\triangleright$ ; any object of TH equipped with a *co-holomorphicization*  $\kappa_{M_k} : M_k \rightarrow \overline{\mathcal{A}}_{\mathbb{X}_{\text{ell}}}$ ; any object of TH $\boxplus$  equipped with an *Aut-holomorphic homomorphism*  $\kappa_{M_k} : M_k \rightarrow \mathcal{A}_{\mathbb{X}_{\text{ell}}} (\subseteq \overline{\mathcal{A}}_{\mathbb{X}_{\text{ell}}})$  (relative to the *multiplicative* structure of  $\mathcal{A}_{\mathbb{X}_{\text{ell}}}$ )); if  $\mathbb{T} \neq \text{TH}, \text{TH}\boxplus$  and  $\kappa_k$  is a  $k$ -Kummer structure on  $\mathbb{X}_{\text{ell}}$ , then write  $\kappa_{M_k} : M_k \rightarrow \overline{\mathcal{A}}_{\mathbb{X}_{\text{ell}}}$  for the restriction of  $\kappa_k$  to  $M_k \subseteq k$ . We shall refer to as a *model Aut-holomorphic  $\mathbb{T}$ -pair* any collection of data (a), (b), (c) of the following form:

- (a) the *elliptically admissible Aut-holomorphic orbispace*  $\mathbb{X}_{\text{ell}}$ ,
- (b) the *object*  $M_k \in \text{Ob}(\mathbb{T})$ ,
- (c) the *datum*  $\kappa_{M_k} : M_k \rightarrow \overline{\mathcal{A}}_{\mathbb{X}_{\text{ell}}}$ .

Also, we shall refer to the datum  $\kappa_{M_k}$  of (c) as the *Kummer structure* of the model Aut-holomorphic  $\mathbb{T}$ -pair; we shall often use the abbreviated notation  $(\mathbb{X}_{\text{ell}} \overset{\kappa}{\curvearrowright} M_k)$  for this collection of data (a), (b), (c).

(ii) We shall refer to any collection of data  $(\mathbb{X} \overset{\kappa}{\curvearrowright} M)$  consisting of an elliptically admissible Aut-holomorphic orbispace  $\mathbb{X}$ , an object  $M \in \text{Ob}(\mathbb{T})$ , and a datum  $\kappa_M : M \rightarrow \overline{\mathcal{A}}_{\mathbb{X}}$ , which we shall refer to as the *Kummer structure* of  $(\mathbb{X} \overset{\kappa}{\curvearrowright} M)$ , as an *Aut-holomorphic  $\mathbb{T}$ -pair* if the following conditions are satisfied: (a)  $\kappa_M$  is a continuous map between the underlying topological spaces whenever  $\mathbb{T} \neq \mathbb{TH}$ ; (b)  $\kappa_M$  is a collection of continuous maps from open subsets of the underlying topological space of  $M$  to the underlying topological space of  $\overline{\mathcal{A}}_{\mathbb{X}}$  whenever  $\mathbb{T} = \mathbb{TH}$ ; (c) for some model Aut-holomorphic  $\mathbb{T}$ -pair  $(\mathbb{X}_{\text{ell}} \overset{\kappa}{\curvearrowright} M_k)$  (where the notation is as in (i)), there exist an isomorphism  $\mathbb{X}_{\text{ell}} \xrightarrow{\sim} \mathbb{X}$  of objects of  $\mathbb{TH}$  and an isomorphism  $M_k \xrightarrow{\sim} M$  of objects of  $\mathbb{T}$  that are compatible with the respective *Kummer structures*  $\kappa_{M_k} : M_k \rightarrow \overline{\mathcal{A}}_{\mathbb{X}_{\text{ell}}}$ ,  $\kappa_M : M \rightarrow \overline{\mathcal{A}}_{\mathbb{X}}$ . In this situation, we shall refer to  $\mathbb{X}$  as the *structure-orbispace* and to  $M$  as the *arithmetic data* of the Aut-holomorphic  $\mathbb{T}$ -pair  $(\mathbb{X} \overset{\kappa}{\curvearrowright} M)$ ; if, in this situation, the structure-orbispace  $\mathbb{X}$  arises from a hyperbolic orbicurve which is of strictly Belyi type (cf. Remark 2.8.3), then we shall refer to the Aut-holomorphic  $\mathbb{T}$ -pair  $(\mathbb{X} \overset{\kappa}{\curvearrowright} M)$  as being *of strictly Belyi type*. A *morphism of Aut-holomorphic  $\mathbb{T}$ -pairs*

$$\phi : (\mathbb{X}_1 \overset{\kappa}{\curvearrowright} M_1) \rightarrow (\mathbb{X}_2 \overset{\kappa}{\curvearrowright} M_2)$$

consists of a *morphism* of objects  $\phi_M : M_1 \rightarrow M_2$  of  $\mathbb{T}$ , together with a *compatible* (relative to the respective Kummer structures) *finite étale morphism*  $\phi_{\mathbb{X}} : \mathbb{X}_1 \rightarrow \mathbb{X}_2$  of  $\mathbb{TH}$ ; if, in this situation,  $\phi_M$  (respectively,  $\phi_{\mathbb{X}}$ ) is an isomorphism, then we shall refer to  $\phi$  as a  $\mathbb{T}$ -*isomorphism* (respectively, *structure-isomorphism*).

(iii) Write

$$\mathcal{C}_{\mathbb{T}}^{\text{hol}}$$

for the *category* whose *objects* are the *Aut-holomorphic  $\mathbb{T}$ -pairs* and whose *morphisms* are the *morphisms of Aut-holomorphic  $\mathbb{T}$ -pairs*. Also, we shall use the same notation, except with “ $\mathcal{C}$ ” replaced by

$$\underline{\mathcal{C}} \text{ (respectively, } \overline{\mathcal{C}}; \underline{\underline{\mathcal{C}}})$$

to denote the various subcategories determined by the  $\mathbb{T}$ -*isomorphisms* (respectively, *structure-isomorphisms*; *isomorphisms*); we shall use the same notation, with “hol” replaced by

$$\text{hol-sB}$$



to denote the various full subcategories determined by the objects of *strictly Belyi type*. Since (in the notation of (i)) the formation of  $\mathcal{O}_k^\triangleright$  (respectively,  $k^\times$ ;  $\mathcal{O}_k^\times$ ;  $\mathcal{O}_k^\times$ ) from  $k$  (respectively,  $\mathcal{O}_k^\triangleright$ ;  $\mathcal{O}_k^\triangleright$ ;  $k^\times$ ) is clearly *intrinsically defined* (i.e., depends only on the “input data of an object of  $\mathbb{T}$ ”), we thus obtain *natural functors*

$$\mathcal{C}_{\mathbb{TF}}^{\text{hol}} \rightarrow \mathcal{C}_{\mathbb{TM}}^{\text{hol}}; \quad \mathcal{C}_{\mathbb{TM}}^{\text{hol}} \rightarrow \mathcal{C}_{\mathbb{TLG}}^{\text{hol}}; \quad \mathcal{C}_{\mathbb{TM}}^{\text{hol}} \rightarrow \mathcal{C}_{\mathbb{TCG}}^{\text{hol}}; \quad \mathcal{C}_{\mathbb{TLG}}^{\text{hol}} \rightarrow \mathcal{C}_{\mathbb{TCG}}^{\text{hol}}$$

— i.e., by taking the *multiplicative monoid* of nonzero elements of absolute value  $\leq 1$  of the arithmetic data (i.e., nonzero elements of the closure of the set of elements  $a$  such that  $a^n \rightarrow 0$  as  $n \rightarrow \infty$ ), the associated *groupification*  $M^{\text{gp}}$  of the arithmetic data  $M$ , the *subgroup of invertible elements*  $M^\times$  of the arithmetic data  $M$ , or the *maximal compact subgroup* of the arithmetic data. Finally, we shall write

$$\mathbb{TH} \supseteq \mathbb{EA} \supseteq \mathbb{EA}^{\text{sB}}$$

for the subcategories determined, respectively, by the *elliptically admissible* hyperbolic orbicurves over CAF’s and the *finite étale morphisms*, and by the *elliptically admissible* hyperbolic orbicurves of *strictly Belyi type* over CAF’s and the *finite étale morphisms*; also, we shall use the same notation, except with “ $\mathbb{EA}$ ” replaced by  $\underline{\mathbb{EA}}$  to denote the subcategory determined by the *isomorphisms*. Thus, for  $\mathbb{T} \in \{\mathbb{TF}, \mathbb{TCG}, \mathbb{TLG}, \mathbb{TM}, \mathbb{TH}, \mathbb{TH}\mathbb{H}\}$ , the assignment  $(\mathbb{X} \overset{\kappa}{\curvearrowright} M) \mapsto \mathbb{X}$  determines various *compatible natural functors*

$$\mathcal{C}_{\mathbb{T}}^{\text{hol}} \rightarrow \mathbb{EA}$$

(as well as *double underlined* versions of these functors).

(iv) Observe that (in the notation of (i)) the field structure of  $k$  determines, via the inverse morphism to  $\log_k$ , a structure of *topological field* on the topological group  $k^\sim$ ; moreover,  $\kappa_k$  determines a  *$k^\sim$ -Kummer structure* on  $\mathbb{X}_{\text{ell}}$

$$\kappa_{k^\sim} : k^\sim \xrightarrow{\sim} \overline{\mathcal{A}}_{\mathbb{X}_{\text{ell}}}$$

which may be *uniquely* characterized (i.e., among the *two*  $k^\sim$ -Kummer structures on  $\mathbb{X}_{\text{ell}}$ ) by the property that the *co-holomorphicization* determined by  $\kappa_{k^\sim}$  coincides with the co-holomorphicization determined by composing the composite of natural maps  $k^\sim \twoheadrightarrow k^\times \hookrightarrow k$  with the co-holomorphicization

determined by  $\kappa_k$ . In particular, (cf. (i)) the co-holomorphicizations determined by  $\kappa_k, \kappa_{k^\sim}$  are *compatible* with  $\log_k$ . Since the various operations applied here to construct this field structure on  $k^\sim$  (such as, for instance, the *power series* used to define  $\log_k$ ) are clearly *intrinsically defined* (cf. the natural functors defined in (iii)), we thus obtain that the construction that assigns

$$\begin{aligned} & \text{(the topological field } k, \text{ with its Kummer structure } \kappa_k) \\ & \mapsto \text{(the topological field } k^\sim, \text{ with its Kummer structure } \kappa_{k^\sim}) \end{aligned}$$

determines a *natural functor*

$$\mathbf{log}_{\mathbb{T}\mathbb{F}, \mathbb{T}\mathbb{F}} : \mathcal{C}_{\mathbb{T}\mathbb{F}}^{\text{hol}} \rightarrow \mathcal{C}_{\mathbb{T}\mathbb{F}}^{\text{hol}}$$

— which we shall refer to as the *log-Frobenius functor*. Since  $\log_k$  determines a *functorial isomorphism* between the fields  $k, k^\sim$ , it follows immediately that the functor  $\mathbf{log}_{\mathbb{T}\mathbb{F}, \mathbb{T}\mathbb{F}}$  is *isomorphic to the identity functor* (hence, in particular, is an *equivalence of categories*). By composing  $\mathbf{log}_{\mathbb{T}\mathbb{F}, \mathbb{T}\mathbb{F}}$  with the various natural functors defined in (iii), we also obtain, for  $\mathbb{T} \in \{\text{TLG}, \text{TCG}, \text{TM}\}$ , a functor

$$\mathbf{log}_{\mathbb{T}\mathbb{F}, \mathbb{T}} : \mathcal{C}_{\mathbb{T}\mathbb{F}}^{\text{hol}} \rightarrow \mathcal{C}_{\mathbb{T}}^{\text{hol}}$$

— which (by abuse of terminology) we shall also refer to as “*the log-Frobenius functor*”. In a similar vein, the assignments

$$\begin{aligned} & \text{(the topological field } k, \text{ with its Kummer structure } \kappa_k) \\ & \mapsto \text{(the Aut-holomorphic space } k^\times, \text{ with its Kummer structure } [\kappa_k|_{k^\times}]) \\ & \text{(the topological field } k, \text{ with its Kummer structure } \kappa_k) \\ & \mapsto \text{(the Aut-holomorphic space } k^\sim, \text{ with its Kummer structure } [\kappa_{k^\sim}]) \end{aligned}$$

— where the  $[-]$ ’s denote the associated *co-holomorphicizations*; the phrase “the Aut-holomorphic space” should, strictly speaking, be interpreted as meaning “the Aut-holomorphic space determined by” — determine *natural functors*

$$\lambda^\times : \mathcal{C}_{\mathbb{T}\mathbb{F}}^{\text{hol}} \rightarrow \mathcal{C}_{\mathbb{T}\mathbb{H}}^{\text{hol}}; \quad \lambda^\sim : \mathcal{C}_{\mathbb{T}\mathbb{F}}^{\text{hol}} \rightarrow \mathcal{C}_{\mathbb{T}\mathbb{H}}^{\text{hol}}$$

together with *diagrams of functors*

$$\begin{array}{ccc}
 \mathcal{C}_{\mathbb{T}\mathbb{F}}^{\text{hol}} & \xrightarrow{\log_{\mathbb{T}\mathbb{F}, \mathbb{T}\mathbb{F}}} & \mathcal{C}_{\mathbb{T}\mathbb{F}}^{\text{hol}} \\
 \downarrow \lambda^{\sim} & \swarrow \iota_{\log} & \downarrow \lambda^{\times} \\
 \mathcal{C}_{\mathbb{T}\mathbb{H}}^{\text{hol}} & = & \mathcal{C}_{\mathbb{T}\mathbb{H}}^{\text{hol}}
 \end{array}
 \qquad
 \begin{array}{ccc}
 & \mathcal{C}_{\mathbb{T}\mathbb{F}}^{\text{hol}} & \\
 \lambda^{\times} \downarrow & \swarrow \iota_{\times} & \downarrow \lambda^{\sim} \\
 & \mathcal{C}_{\mathbb{T}\mathbb{H}}^{\text{hol}} &
 \end{array}$$

— where we write  $\iota_{\log} : \lambda^{\times} \circ \log_{\mathbb{T}\mathbb{F}, \mathbb{T}\mathbb{F}} \rightarrow \lambda^{\sim}$  for the natural transformation induced by the natural inclusion “ $(k^{\sim})^{\times} \hookrightarrow k^{\sim}$ ” and  $\iota_{\times} : \lambda^{\sim} \rightarrow \lambda^{\times}$  for the natural transformation induced by the natural map “ $k^{\sim} \twoheadrightarrow k^{\times}$ ”. Finally, we note that the fields “ $k^{\sim}$ ” obtained by the above construction (i.e., the arithmetic data of the objects in the image of the log-Frobenius functor  $\log_{\mathbb{T}\mathbb{F}, \mathbb{T}\mathbb{F}}$ ) are equipped with a *natural “subquotient compactum”* — i.e., the compact subset “ $\mathcal{O}_k^{\times} \subseteq k^{\times}$ ” that lies in the natural quotient “ $k^{\sim} \twoheadrightarrow k^{\times}$ ” — which we shall refer to as the *pre-log-shell* of  $\log_{\mathbb{T}\mathbb{F}, \mathbb{T}\mathbb{F}}^{\text{arith}}(\mathbb{X} \overset{\kappa}{\curvearrowright} M)$

$$\lambda_{(\mathbb{X} \overset{\kappa}{\curvearrowright} M)}$$

— where  $(\mathbb{X} \overset{\kappa}{\curvearrowright} M) \in \text{Ob}(\mathcal{C}_{\mathbb{T}\mathbb{F}}^{\text{hol}})$ ;  $\lambda_{(\mathbb{X} \overset{\kappa}{\curvearrowright} M)}$  is a *subquotient* of the arithmetic data  $\log_{\mathbb{T}\mathbb{F}, \mathbb{T}\mathbb{F}}^{\text{arith}}(\mathbb{X} \overset{\kappa}{\curvearrowright} M)$  of the object determined by applying the log-Frobenius functor  $\log_{\mathbb{T}\mathbb{F}, \mathbb{T}\mathbb{F}}$  to the object  $(\mathbb{X} \overset{\kappa}{\curvearrowright} M)$ .

(v) Write  $\mathfrak{L}\mathfrak{i}\mathfrak{n}\mathfrak{h}\mathfrak{o}\mathfrak{l}$  (i.e., “*linear holomorphic*”) for the category whose *objects* are pairs

$$\left( \mathbb{X}, \mathbb{X} \overset{\kappa}{\curvearrowright} \overline{\mathcal{A}}_{\mathbb{X}} \right)$$

consisting of an object  $\mathbb{X} \in \text{Ob}(\mathbb{E}\mathbb{A})$ , together with the *tautological Kummer map*  $\overline{\mathcal{A}}_{\mathbb{X}} \xrightarrow{\sim} \overline{\mathcal{A}}_{\mathbb{X}}$  (i.e., given by the *identity* on the object of  $\mathbb{T}\mathbb{F}$  determined by  $\overline{\mathcal{A}}_{\mathbb{X}}$ ) — all of which is to be understood as constructed via the *algorithms* of Corollary 2.7 (cf. Remark 3.1.2) — and whose *morphisms* are the morphisms induced by the (finite étale) morphisms of  $\mathbb{E}\mathbb{A}$  (cf. the *functorial algorithms* of Corollary 2.7). Thus, we obtain a *natural functor*

$$\mathbb{E}\mathbb{A} \xrightarrow{\kappa \mathfrak{L}\mathfrak{h}} \mathfrak{L}\mathfrak{i}\mathfrak{n}\mathfrak{h}\mathfrak{o}\mathfrak{l}$$

which (as is easily verified) is an *equivalence of categories*, a quasi-inverse for which is given by the natural projection functor  $\mathfrak{L}\mathfrak{i}\mathfrak{n}\mathfrak{h}\mathfrak{o}\mathfrak{l} \rightarrow \mathbb{E}\mathbb{A}$ .

REMARK 4.1.1. The *topological monoid* “ $\mathcal{O}_k^{\triangleright}$ ” associated to a CAF  $k$  (cf. Definition 4.1, (i)) is essentially the data used to construct the *archimedean Frobenioids* of [Mzk17], Example 3.3, (ii).

REMARK 4.1.2. Although, to simplify the discussion, we have chosen to require that the *structure-orbispace* always be *elliptically admissible*, and that the base field always be a CAF, many aspects of the theory of the present §4 may be generalized to accommodate “structure-orbspaces” that are Aut-holomorphic orbispaces that arise from *more general hyperbolic orbicurves* (cf., e.g., Propositions 2.5, 2.6; Remark 2.6.1) over *arbitrary archimedean fields* (i.e., either CAF’s or RAF’s — cf. §0). Such generalizations, however, are beyond the scope of the present paper.

PROPOSITION 4.2 (First Properties of Aut-Holomorphic Pairs).

(i) Let  $\mathbb{T} \in \{\text{TM}, \text{TF}, \text{TLG}, \text{TCG}\}$ ;  $(\mathbb{X} \overset{\kappa}{\curvearrowright} M), (\mathbb{X}^* \overset{\kappa}{\curvearrowright} M^*) \in \text{Ob}(\mathcal{C}_{\mathbb{T}}^{\text{hol}})$ . Then the natural functor of Definition 4.1, (iii), induces a bijection (cf. Proposition 3.2, (iv))

$$\text{Isom}_{\mathcal{C}_{\mathbb{T}}^{\text{hol}}}((\mathbb{X} \overset{\kappa}{\curvearrowright} M), (\mathbb{X}^* \overset{\kappa}{\curvearrowright} M^*)) \xrightarrow{\sim} \text{Isom}_{\mathbb{EA}}(\mathbb{X}, \mathbb{X}^*)$$

on sets of isomorphisms. In particular, the categories  $\mathbb{EA}, \mathcal{C}_{\mathbb{T}}^{\text{hol}} = \underline{\mathcal{C}}_{\mathbb{T}}^{\text{hol}}, \mathcal{C}_{\mathbb{T}}^{\text{hol-sB}} = \underline{\mathcal{C}}_{\mathbb{T}}^{\text{hol-sB}}$  are id-rigid.

(ii) The equivalence of categories  $\kappa_{\mathfrak{L}\mathfrak{S}} : \mathbb{EA} \xrightarrow{\sim} \mathfrak{L}\mathfrak{in}\mathfrak{H}\mathfrak{o}\mathfrak{l}$  of Definition 4.1, (v) — i.e., the functorial algorithms of Corollary 2.7 — determines a natural (1-)factorization (cf. Proposition 3.2, (v))

$$\mathcal{C}_{\text{TF}}^{\text{hol}} \longrightarrow \mathcal{C}_{\text{TM}}^{\text{hol}} \xrightarrow{\text{log}_{\text{TM}, \text{T}}} \mathcal{C}_{\mathbb{T}}^{\text{hol}}$$

— where  $\mathbb{T} \in \{\text{TF}, \text{TLG}, \text{TCG}, \text{TM}\}$ ; the first arrow is the natural functor of Definition 4.1, (iii) — of the log-Frobenius functors  $\text{log}_{\text{TF}, \mathbb{T}} : \mathcal{C}_{\text{TF}}^{\text{hol}} \rightarrow \mathcal{C}_{\mathbb{T}}^{\text{hol}}$  of Definition 4.1, (iv). Moreover, (when  $\mathbb{T} \in \{\text{TF}, \text{TM}\}$ ) the functor  $\text{log}_{\mathbb{T}, \mathbb{T}}$  is isomorphic to the identity functor (hence, in particular, is an equivalence of categories).

PROOF. The *bijection* portion of assertion (i) follows immediately from the required compatibility of morphisms of  $\mathcal{C}_{\mathbb{T}}^{\text{hol}}$  with the *Kummer structures* of the objects involved (cf. also the *functorial algorithms* of Corollary 2.7). To verify the *id-rigidity* of  $\mathbb{EA}$ , it suffices to observe that for any object  $\mathbb{X} \in \text{Ob}(\mathbb{EA})$ , which necessarily arises from some *elliptically admissible* hyperbolic orbicurve  $X$  over a CAF, the *full subcategory* of  $\mathbb{EA}$  consisting of objects that map to  $\mathbb{X}$  may, by Corollary 2.3, (i) (cf. also [Mzk14], Lemma 1.3, (iii)), be identified with the *category of finite étale  $\mathbb{R}$ -localizations* “ $\text{Loc}_{\mathbb{R}}(X)$ ” (i.e., the subcategory of the *category of finite étale localizations* “ $\text{Loc}(X)$ ” of [Mzk10], §2, obtained by considering the  *$\mathbb{R}$ -linear* morphisms). Thus, the *id-rigidity* of  $\mathbb{EA}$  follows immediately from the *slimness* assertion of Lemma 4.3 below. In light of the *bijection* portion of assertion (i), the *id-rigidity* of the categories  $\mathcal{C}_{\mathbb{T}}^{\text{hol}} = \underline{\mathcal{C}}_{\mathbb{T}}^{\text{hol}}$ ,  $\mathcal{C}_{\mathbb{T}}^{\text{hol-sB}} = \underline{\mathcal{C}}_{\mathbb{T}}^{\text{hol-sB}}$  follows in a similar fashion. This completes the proof of assertion (i). Assertion (ii) follows immediately from the definitions (and the *functorial algorithms* of Corollary 2.7).  $\square$

REMARK 4.2.1. Note that, unlike the case with Proposition 3.2, (iv), the *id-rigidity* portion of Proposition 4.2, (i), is (as is easily verified) *false* for the “ $\overline{\mathcal{C}}$ ” and “ $\underline{\underline{\mathcal{C}}}$ ” versions of  $\mathcal{C}_{\mathbb{T}}^{\text{hol}}$ ,  $\mathcal{C}_{\mathbb{T}}^{\text{hol-sB}}$ .

The following result is well-known.

LEMMA 4.3 (Slimness of Archimedean Fundamental Groups). *Let  $X$  be a hyperbolic orbicurve over an archimedean field  $k_X$ . Then the étale fundamental group  $\Pi_X$  of  $X$  is slim.*

PROOF. Let  $\overline{k}_X$  be an *algebraic closure* of  $k_X$ . Thus, we have an exact sequence of profinite groups

$$1 \rightarrow \Delta_X \rightarrow \Pi_X \rightarrow G \rightarrow 1$$

(where  $\Delta_X \stackrel{\text{def}}{=} \pi_1(X \times_{k_X} \overline{k}_X)$ ;  $G \stackrel{\text{def}}{=} \text{Gal}(\overline{k}_X/k_X)$ ). Since  $\Delta_X$  is *slim* (cf., e.g., [Mzk20], Proposition 2.3, (i)), it suffices to consider the case where there exists an element  $\sigma \in \Pi_X$  that maps to a *nontrivial element*  $\sigma_G \in G \cong \mathbb{Z}/2\mathbb{Z}$  and, moreover, *commutes* with some open subgroup  $H \subseteq \Pi_X$ . We may

assume without loss of generality that  $H \subseteq \Delta_X$ , and, moreover, that  $H$  corresponds to a finite étale covering of  $X \times_{k_X} \bar{k}_X$  which is a *hyperbolic curve of genus  $\geq 2$* . In particular, by replacing  $X$  by the finite étale covering of  $X$  determined by the open subgroup of  $\Pi_X$  generated by  $H$  and  $\sigma$ , we may assume that  $\sigma$  lies in the center of  $\Pi_X$ , and, moreover, that  $X$  is a *hyperbolic curve of genus  $\geq 2$* . In particular, by filling in the cusps of  $X$ , we may assume further that  $X$  is *proper*. Now if  $l$  is any prime number, then the *first Chern class* of, say, the *canonical bundle* of  $X$  determines a *generator* of  $H^2(X \times_{k_X} \bar{k}_X, \mathbb{Q}_l(1)) \cong H^2(\Delta_X, \mathbb{Q}_l(1))$  (where the “(1)” denotes a Tate twist), hence an *isomorphism of  $G$ -modules*  $H^2(\Delta_X, \mathbb{Q}_l) \xrightarrow{\sim} \mathbb{Q}_l(-1)$ . In particular, it follows that  $\sigma$  acts *nontrivially* on  $H^2(\Delta_X, \mathbb{Q}_l)$ , in contradiction to the fact that  $\sigma$  lies in the center of  $\Pi_X$ . This contradiction completes the proof of Lemma 4.3.  $\square$

LEMMA 4.4 (Topological Distinguishability of Additive and Multiplicative Structures). *Let  $k$  be a CAF (cf. Definition 4.1, (i)). Then (in the notation of Definition 4.1, (i)) no composite of the form*

$$k^\times \xrightarrow{\alpha} (k^\sim)^\times \hookrightarrow k^\sim \twoheadrightarrow k^\times$$

— where the “ $\times$ ” of “ $(k^\sim)^\times$ ” is relative to the field structure of  $k^\sim$  (cf. Definition 4.1, (iv));  $\alpha$  is an isomorphism of topological groups; “ $\hookrightarrow$ ” is the natural inclusion; “ $\twoheadrightarrow$ ” is the natural map — is bijective.

PROOF. Indeed, the *non-injectivity* of  $k^\sim \twoheadrightarrow k^\times$  implies that the composite under consideration *fails to be injective*.  $\square$

COROLLARY 4.5 (Aut-Holomorphic Mono-anabelian Log-Frobenius Compatibility). *Write*

$$\mathcal{X} \stackrel{\text{def}}{=} \underline{\mathcal{C}}_{\mathbb{T}}^{\text{hol}} = \mathcal{C}_{\mathbb{T}}^{\text{hol}}; \quad \mathcal{E} \stackrel{\text{def}}{=} \mathbb{E}\mathbb{A}; \quad \mathcal{N} \stackrel{\text{def}}{=} \mathcal{C}_{\mathbb{T}\mathbb{H}}^{\text{hol}}$$

— where (in the notation of Definition 3.1)  $\mathbb{T} \in \{\mathbb{T}\mathbb{M}, \mathbb{T}\mathbb{F}\}$ . Consider the

diagram of categories  $\mathcal{D}$

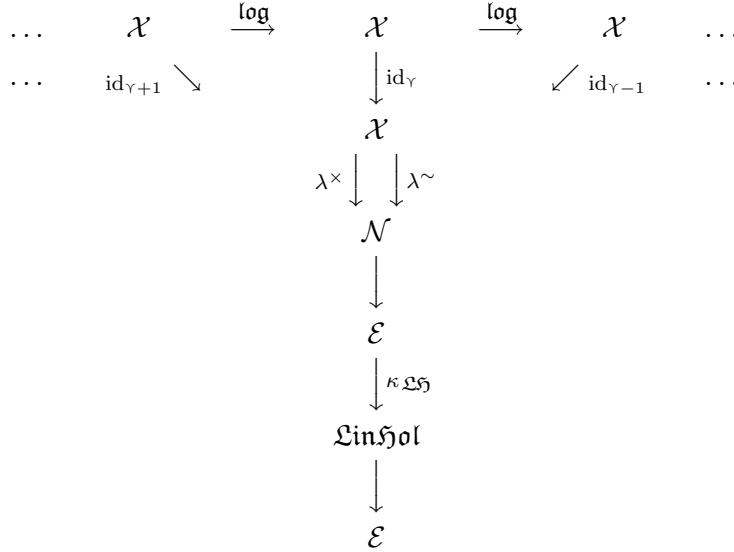

— where we use the notation “log”, “ $\lambda^{\times}$ ”, “ $\lambda^{\sim}$ ” for the arrows “ $\text{log}_{\mathbb{T},\mathbb{T}}$ ”, “ $\lambda^{\times}$ ”, “ $\lambda^{\sim}$ ” of Definition 4.1, (iv) (cf. also Proposition 4.2, (ii)); we employ the conventions of Corollary 3.6 concerning subdiagrams of  $\mathcal{D}$ ; we write  $L$  for the countably ordered set determined by (cf. §0) the infinite linear oriented graph  $\bar{\Gamma}_{\mathcal{D}_{\leq 1}}^{\text{opp}}$  (so the elements of  $L$  correspond to vertices of the first row of  $\mathcal{D}$ ) and

$$L^{\dagger} \stackrel{\text{def}}{=} L \cup \{\square\}$$

for the ordered set obtained by appending to  $L$  a formal symbol  $\square$  (which we think of as corresponding to the unique vertex of the second row of  $\mathcal{D}$ ) such that  $\square < \gamma$ , for all  $\gamma \in L$ ;  $\text{id}_{\gamma}$  denotes the identity functor at the vertex  $\gamma \in L$ . Then:

(i) For  $n = 4, 5, 6$ ,  $\mathcal{D}_{\leq n}$  admits a natural structure of core on  $\mathcal{D}_{\leq n-1}$ . That is to say, loosely speaking,  $\mathcal{E}$ ,  $\mathfrak{Lin}\mathfrak{Sol}$  “form cores” of the functors in  $\mathcal{D}$ .

(ii) The assignments

$$\left(\mathbb{X}, \mathbb{X} \overset{\kappa}{\curvearrowright} \bar{\mathcal{A}}_{\mathbb{X}}\right) \mapsto \left(\mathbb{X} \overset{\kappa}{\curvearrowright} \bar{\mathcal{A}}_{\mathbb{X}}^{\triangleright}\right), \quad \left(\mathbb{X} \overset{\kappa}{\curvearrowright} \bar{\mathcal{A}}_{\mathbb{X}}\right)$$

(where we write “ $\overline{\mathcal{A}}^\triangleright$ ” for the monoid of nonzero elements of absolute value  $\leq 1$  of the CAF given by “ $\overline{\mathcal{A}}$ ”) determine (i.e., for each choice of  $\mathbb{T}$ ) a natural “forgetful” functor

$$\mathfrak{L}\mathfrak{in}\mathfrak{h}\mathfrak{o}\mathfrak{l} \xrightarrow{\phi_{\mathfrak{L}\mathfrak{S}\mathfrak{H}}} \mathcal{X}$$

which is an equivalence of categories, a quasi-inverse for which is given by the composite  $\pi_{\mathfrak{L}\mathfrak{S}\mathfrak{H}} : \mathcal{X} \rightarrow \mathfrak{L}\mathfrak{in}\mathfrak{h}\mathfrak{o}\mathfrak{l}$  of the natural projection functor  $\mathcal{X} \rightarrow \mathcal{E}$  with  $\kappa_{\mathfrak{L}\mathfrak{S}\mathfrak{H}} : \mathcal{E} \rightarrow \mathfrak{L}\mathfrak{in}\mathfrak{h}\mathfrak{o}\mathfrak{l}$ ; write  $\eta_{\mathfrak{L}\mathfrak{S}\mathfrak{H}} : \phi_{\mathfrak{L}\mathfrak{S}\mathfrak{H}} \circ \pi_{\mathfrak{L}\mathfrak{S}\mathfrak{H}} \xrightarrow{\sim} \text{id}_{\mathcal{X}}$  for the tautological isomorphism arising from the definitions (cf. Definition 4.1, (i), (ii)). Moreover,  $\phi_{\mathfrak{L}\mathfrak{S}\mathfrak{H}}$  gives rise to a telecore structure  $\mathfrak{T}_{\mathfrak{L}\mathfrak{S}\mathfrak{H}}$  on  $\mathcal{D}_{\leq 4}$ , whose underlying diagram of categories we denote by  $\mathcal{D}_{\mathfrak{L}\mathfrak{S}\mathfrak{H}}$ , by appending to  $\mathcal{D}_{\leq 5}$  telecore edges

$$\begin{array}{ccccccc} & & & \mathfrak{L}\mathfrak{in}\mathfrak{h}\mathfrak{o}\mathfrak{l} & & & \\ & & & \downarrow \phi_{\Upsilon} & & & \\ \dots & \phi_{\Upsilon+1} \swarrow & & & \searrow \phi_{\Upsilon-1} & & \dots \\ & \mathcal{X} & \xrightarrow{\text{log}} & \mathcal{X} & \xrightarrow{\text{log}} & \mathcal{X} & \dots \\ & & & \mathfrak{L}\mathfrak{in}\mathfrak{h}\mathfrak{o}\mathfrak{l} & \xrightarrow{\phi_{\square}} & \mathcal{X} & \end{array}$$

from the core  $\mathfrak{L}\mathfrak{in}\mathfrak{h}\mathfrak{o}\mathfrak{l}$  to the various copies of  $\mathcal{X}$  in  $\mathcal{D}_{\leq 2}$  given by copies of  $\phi_{\mathfrak{L}\mathfrak{S}\mathfrak{H}}$ , which we denote by  $\phi_{\lambda}$ , for  $\lambda \in L^\dagger$ . That is to say, loosely speaking,  $\phi_{\mathfrak{L}\mathfrak{S}\mathfrak{H}}$  determines a telecore structure on  $\mathcal{D}_{\leq 4}$ . Finally, for each  $\lambda \in L^\dagger$ , let us write  $[\beta_\lambda^0]$  for the path on  $\vec{\Gamma}_{\mathcal{D}_{\mathfrak{L}\mathfrak{S}\mathfrak{H}}}$  of length 0 at  $\lambda$  and  $[\beta_\lambda^1]$  for the path on  $\vec{\Gamma}_{\mathcal{D}_{\mathfrak{L}\mathfrak{S}\mathfrak{H}}}$  of length  $\in \{4, 5\}$  (i.e., depending on whether or not  $\lambda = \square$ ) that starts from  $\lambda$ , descends (say, via  $\lambda^\times$ ) to the core vertex “ $\mathfrak{L}\mathfrak{in}\mathfrak{h}\mathfrak{o}\mathfrak{l}$ ”, and returns to  $\lambda$  via the telecore edge  $\phi_\lambda$ . Then the collection of natural transformations

$$\{\eta_{\square\Upsilon}, \eta_{\square\Upsilon}^{-1}, \eta_\lambda, \eta_\lambda^{-1}\}_{\Upsilon \in L, \lambda \in L^\dagger}$$

— where we write  $\eta_{\square\Upsilon}$  for the identity natural transformation from the arrow  $\phi_{\square} : \mathfrak{L}\mathfrak{in}\mathfrak{h}\mathfrak{o}\mathfrak{l} \rightarrow \mathcal{X}$  to the composite arrow  $\text{id}_\Upsilon \circ \phi_\Upsilon : \mathfrak{L}\mathfrak{in}\mathfrak{h}\mathfrak{o}\mathfrak{l} \rightarrow \mathcal{X}$  and

$$\eta_\lambda : (\mathcal{D}_{\mathfrak{L}\mathfrak{S}\mathfrak{H}})_{[\beta_\lambda^1]} \xrightarrow{\sim} (\mathcal{D}_{\mathfrak{L}\mathfrak{S}\mathfrak{H}})_{[\beta_\lambda^0]}$$

for the isomorphism arising from  $\eta_{\mathfrak{L}\mathfrak{S}\mathfrak{H}}$  — generate a contact structure  $\mathcal{H}_{\mathfrak{L}\mathfrak{S}\mathfrak{H}}$  on the telecore  $\mathfrak{T}_{\mathfrak{L}\mathfrak{S}\mathfrak{H}}$ .

(iii) The natural transformations

$$\mathcal{L}_{\text{log}, \Upsilon} : \lambda^\times \circ \text{id}_\Upsilon \circ \text{log} \rightarrow \lambda^\sim \circ \text{id}_{\Upsilon+1}, \quad \mathcal{L}_\times : \lambda^\sim \rightarrow \lambda^\times$$



(cf. Definition 4.1, (iv)) belong to a family of homotopies on  $\mathcal{D}_{\leq 3}$  that determines on  $\mathcal{D}_{\leq 3}$  a structure of observable  $\mathfrak{S}_{\text{log}}$  on  $\mathcal{D}_{\leq 2}$  and, moreover, is compatible with the families of homotopies that constitute the core and telecore structures of (i), (ii).

(iv) The diagram of categories  $\mathcal{D}_{\leq 2}$  does not admit a structure of core on  $\mathcal{D}_{\leq 1}$  which (i.e., whose constituent family of homotopies) is compatible with (the constituent family of homotopies of) the observable  $\mathfrak{S}_{\text{log}}$  of (iii). Moreover, the telecore structure  $\mathfrak{T}_{\mathfrak{S}\mathfrak{H}}$  of (ii), the contact structure  $\mathcal{H}_{\mathfrak{S}\mathfrak{H}}$  of (ii), and the observable  $\mathfrak{S}_{\text{log}}$  of (iii) are not simultaneously compatible (but cf. Remark 3.7.3, (ii)).

(v) The unique vertex  $\square$  of the second row of  $\mathcal{D}$  is a nexus of  $\vec{\Gamma}_{\mathcal{D}}$ . Moreover,  $\mathcal{D}$  is totally  $\square$ -rigid, and the natural action of  $\mathbb{Z}$  on the infinite linear oriented graph  $\vec{\Gamma}_{\mathcal{D}_{\leq 1}}$  extends to an action of  $\mathbb{Z}$  on  $\mathcal{D}$  by nexus-classes of self-equivalences of  $\mathcal{D}$ . Finally, the self-equivalences in these nexus-classes are compatible with the families of homotopies that constitute the cores and observable of (i), (iii); these self-equivalences also extend naturally (cf. the technique of extension applied in Definition 3.5, (vi)) to the diagram of categories (cf. Definition 3.5, (iv), (a)) that constitutes the telecore of (ii), in a fashion that is compatible with both the family of homotopies that constitutes this telecore structure (cf. Definition 3.5, (iv), (b)) and the contact structure  $\mathcal{H}_{\mathfrak{S}\mathfrak{H}}$  of (ii).

PROOF. Assertions (i), (ii) are immediate from the definitions (and the functorial algorithms of Corollary 2.7) — cf. also the proofs of Corollary 3.6, (i), (ii). Next, we consider assertion (iii). If, for  $\gamma \in L$ , one denotes by “ $k_{\gamma}^{\times}$ ” the arithmetic data of type  $\text{TLG}$  (which we may be obtained from an arithmetic data of type  $\mathbb{T} \in \{\text{TML}, \text{TF}\}$  via the natural functors of Definition 4.1, (iii)) of a “typical object” of the copy of  $\mathcal{X}$  at the vertex  $\gamma$  of  $\mathcal{D}_{\leq 1}$ , then  $\underline{\iota}_{\times}$  “applied at the vertex  $\gamma$ ” corresponds to the natural surjection  $k_{\gamma}^{\sim} \twoheadrightarrow k_{\gamma}^{\times}$ , while  $\underline{\iota}_{\text{log}, \gamma}$  corresponds to the natural inclusion  $k_{\gamma}^{\times} \hookrightarrow k_{\gamma+1}^{\sim}$ , where we think of  $k_{\gamma}^{\times}$  as being obtained from  $k_{\gamma+1}^{\times}$  via the application of  $\text{log}$ . In particular, by letting  $\gamma \in L$  vary and composing these natural surjections and inclusions, we obtain a diagram

$$\dots \hookrightarrow k_{\gamma}^{\sim} \twoheadrightarrow k_{\gamma}^{\times} \hookrightarrow k_{\gamma+1}^{\sim} \twoheadrightarrow k_{\gamma+1}^{\times} \hookrightarrow k_{\gamma+2}^{\sim} \twoheadrightarrow k_{\gamma+2}^{\times} \hookrightarrow \dots$$

(which is compatible with the various Kummer structures — cf. Remark 4.5.1, (i), below; the definition of  $\mathcal{C}_{\mathbb{H}\mathbb{H}}^{\text{hol}}$  in Definition 4.1, (i), (ii), (iii)). The

paths on (the oriented graph corresponding to) this diagram may be classified into *four types*, which correspond (by composing, in an alternating fashion, various pull-backs of “ $\underline{L}_{\mathbf{log}, \gamma}$ ” with various pull-backs of  $\underline{L}_\times$ ) to *homotopies* on  $\mathcal{D}_{\leq 3}$ , as follows (cf. the notational conventions of the proof of Corollary 3.6):

- (1) the path corresponding to the composite “ $k_\gamma^\times \rightarrow k_{\gamma+n}^\sim$ ”, which yields a *homotopy* for pairs of paths ( $[\lambda^\times] \circ [\text{id}_\gamma] \circ [\mathbf{log}]^n \circ [\gamma], [\lambda^\sim] \circ [\text{id}_{\gamma+n}] \circ [\gamma]$ )
- (2) the path corresponding to the composite “ $k_\gamma^\times \rightarrow k_{\gamma+n}^\times$ ”, which yields a *homotopy* for pairs of paths ( $[\lambda^\times] \circ [\text{id}_\gamma] \circ [\mathbf{log}]^n \circ [\gamma], [\lambda^\times] \circ [\text{id}_{\gamma+n}] \circ [\gamma]$ )
- (3) the path corresponding to the composite “ $k_\gamma^\sim \rightarrow k_{\gamma+n}^\sim$ ”, which yields a *homotopy* for pairs of paths ( $[\lambda^\sim] \circ [\text{id}_\gamma] \circ [\mathbf{log}]^n \circ [\gamma], [\lambda^\sim] \circ [\text{id}_{\gamma+n}] \circ [\gamma]$ )
- (4) the path corresponding to the composite “ $k_\gamma^\sim \rightarrow k_{\gamma+n-1}^\times$ ”, which yields a *homotopy* for pairs of paths ( $[\lambda^\sim] \circ [\text{id}_\gamma] \circ [\mathbf{log}]^{n-1} \circ [\gamma], [\lambda^\times] \circ [\text{id}_{\gamma+n-1}] \circ [\gamma]$ )

— where  $n \geq 1$  is an integer and  $[\gamma]$  is a path on  $\mathcal{D}_{\leq 1}$ ; in the case of *type (4)*, it is convenient to include also the pair of paths ( $[\lambda^\sim], [\lambda^\times]$ ), for which the natural transformation  $\underline{L}_\times$  determines a *homotopy*. In addition, it is natural to consider the “*identity homotopies*” associated to the pairs

- (5) ( $[\gamma], [\gamma]$ ), where  $[\gamma]$  is a path on  $\mathcal{D}_{\leq 3}$  whose terminal vertex lies in the third row of  $\mathcal{D}_{\leq 3}$ .

Thus, if we take  $E_{\mathbf{log}}$  to be the set of ordered pairs of paths on  $\vec{\Gamma}_{\mathcal{D}_{\leq 3}}$  consisting of pairs of paths of the above five types, then one verifies immediately that  $E_{\mathbf{log}}$  satisfies the conditions (a), (b), (c), (d), (e) given in §0 for a *saturated set*. In particular, the various homotopies discussed above yield a family of homotopies which determines an *observable*  $\mathfrak{S}_{\mathbf{log}}$ , as desired. Moreover, it is immediate from the definitions — i.e., in essence, because the various *structure-orbispaces* that appear remain “*undisturbed*” by the various manipulations involving *arithmetic data* that arise from “ $\underline{L}_{\mathbf{log}, \gamma}$ ”, “ $\underline{L}_\times$ ” — that this family of homotopies is *compatible* with the families of homotopies that constitute the *core* and *telecore* structures of (i), (ii). This completes the proof of assertion (iii).

Next, we consider assertion (iv). Suppose that  $\mathcal{D}_{\leq 2}$  admits a structure of *core* on  $\mathcal{D}_{\leq 1}$  in a fashion that is *compatible* with the observable  $\mathfrak{S}_{\mathbf{log}}$  of (iii). Then this core structure determines a homotopy  $\zeta_0$  for the pair of paths  $([id_\gamma], [id_{\gamma-1}] \circ [log])$  (for  $\gamma \in L$ ); thus, by composing the result  $\zeta'_0$  of applying  $\lambda^\times$  to  $\zeta_0$  with the homotopy  $\zeta_1$  associated (via  $\mathfrak{S}_{\mathbf{log}}$ ) to the pair of paths  $([\lambda^\times] \circ [id_{\gamma-1}] \circ [log], [\lambda^\sim] \circ [id_\gamma])$  (of type (1)) and then with the homotopy  $\zeta_2$  associated (via  $\mathfrak{S}_{\mathbf{log}}$ ) to the pair of paths  $([\lambda^\sim] \circ [id_\gamma], [\lambda^\times] \circ [id_\gamma])$  (of type (4)), we obtain a natural transformation

$$\zeta'_1 = \zeta_2 \circ \zeta_1 \circ \zeta'_0 : \lambda^\times \circ id_\gamma \rightarrow \lambda^\times \circ id_\gamma$$

— which, in order for the desired *compatibility* to hold, must *coincide* with the “*identity homotopy*” (of type (5)). On the other hand, by writing out explicitly the meaning of such an equality  $\zeta'_1 = id$ , we conclude that we obtain a *contradiction* to Lemma 4.4. This completes the proof of the *first incompatibility* of assertion (iv). The proof of the *second incompatibility* of assertion (iv) is entirely similar (cf. the proof of Corollary 3.6, (iv)). This completes the proof of assertion (iv).

Finally, the *total  $\square$ -rigidity* portion of assertion (v) follows immediately from Proposition 4.2, (i) (cf. also the final portion of Proposition 4.2, (ii)); the remainder of assertion (v) follows immediately from the definitions.  $\square$

REMARK 4.5.1.

(i) The “*output*” of the observable  $\mathfrak{S}_{\mathbf{log}}$  of Corollary 4.5, (iii), may be summarized *intuitively* in the following diagram (cf. Remark 3.6.1, (i)):

$$\begin{array}{cccccccc} \dots & k_{\gamma+1}^\times & \leftarrow & k_{\gamma+1}^\sim & \hookrightarrow & k_\gamma^\times & \leftarrow & k_\gamma^\sim & \hookrightarrow & k_{\gamma-1}^\times & \leftarrow & k_{\gamma-1}^\sim & \dots \\ & \downarrow \kappa & & \downarrow \kappa & & \downarrow \kappa & & \downarrow \kappa & & \downarrow \kappa & & \downarrow \kappa & \\ \dots & \mathbb{X}_{\gamma+1} & \xleftarrow{\sim} & \mathbb{X}_{\gamma+1} & \xleftarrow{\sim} & \mathbb{X}_\gamma & \xleftarrow{\sim} & \mathbb{X}_\gamma & \xleftarrow{\sim} & \mathbb{X}_{\gamma-1} & \xleftarrow{\sim} & \mathbb{X}_{\gamma-1} & \dots \end{array}$$

— where the arrows “ $\leftarrow$ ” are the natural surjections (cf.  $\underline{L}_\times!$ );  $k_\gamma^\times$ , for  $\gamma \in L$ , is a copy of “ $k^\times$ ” that arises, via  $id_\gamma$ , from the vertex  $\gamma$  of  $\mathcal{D}_{\leq 1}$ ; the arrows “ $\hookrightarrow$ ” are the inclusions arising from the fact that  $k_\gamma^\times$  is obtained by applying the *log-Frobenius functor*  $log$  to  $k_{\gamma+1}^\times$  (cf.  $\underline{L}_{log,\gamma}!$ ); the “ $\downarrow \kappa$ ”’s denote the various *Kummer structures* involved; the isomorphic “ $\mathbb{X}_\gamma$ ”’s correspond to the *coricity* of  $\mathcal{E}$  (cf. Corollary 4.5, (i)). Finally, the *incompatibility* assertions of Corollary 4.5, (iv), may be thought of as a statement of the

non-existence of some “universal reference model”

$$k_{\text{model}}^\times$$

that maps *isomorphically* to the various  $k_\gamma^\times$ ’s in a fashion that is *compatible* with the various arrows “ $\leftarrow$ ”, “ $\leftrightarrow$ ” of the above diagram.

(ii) In words, the essential content of Corollary 4.5 may be understood as follows (cf. the “intuitive diagram” of (i)):

Although the operation represented by the *log-Frobenius functor* is *compatible* with the (Aut-holomorphic) *structure-orbispaces*, hence with the “software” constituted by the algorithms of Corollary 2.7, it is *not compatible* with the additive or multiplicative structures on the various *arithmetic data* involved — cf. Remark 3.6.1.

That is to say, more concretely, if one starts with an *elliptically admissible* Aut-holomorphic orbispace  $\mathbb{X}$  on which (for some CAF  $k$ )  $k^\times$  “acts via the local linear holomorphic structures of Corollary 2.7, (e)” (i.e.,  $\mathbb{X}$  is equipped with a *Kummer structure*  $\mathbb{X} \overset{\kappa}{\curvearrowright} k^\times$ ), then applies  $\log_k$  to the universal covering  $k^\sim \rightarrow k^\times$  to equip  $k^\sim$  with a *field structure*, with respect to which  $k^\sim$  “acts” on some isomorph  $\mathbb{X}'$  of  $\mathbb{X}$

$$\begin{array}{ccccc} k^\times & \leftarrow & k^\sim & \leftrightarrow & (k^\sim)^\times \\ \overset{\kappa}{\curvearrowright} & & & & \overset{\kappa}{\curvearrowright} \\ \mathbb{X} & & \xrightarrow{\sim} & & \mathbb{X}' \end{array}$$

(where the “ $\times$ ” of “ $(k^\sim)^\times$ ” is taken with respect to this field structure of  $k^\sim$ ), then although the “actions” of  $k^\times$ ,  $(k^\sim)^\times$  on  $\mathbb{X} \xrightarrow{\sim} \mathbb{X}'$  are *not strictly compatible* (i.e., the diagram does *not* commute), they become “compatible” if one “loosens one’s notion of compatibility” to the notion of being “compatible with the (Aut-)holomorphic structure” of the various objects involved (cf. the analogy of Remark 2.7.3). This state of affairs may be expressed formally as a *compatibility* between the various *co-holomorphicizations* involved (cf. the definition of  $C_{\mathbb{H}}^{\text{hol}}$  in Definition 4.1, (i), (ii), (iii)). In summary, as should be evident from its statement, Corollary 4.5 is intended as an *archimedean analogue* of Corollary 3.6. In particular, the “general formal

*content*” of Remarks 3.6.1, 3.6.2, 3.6.3, 3.6.5, 3.6.6, and 3.6.7 applies to the present archimedean situation, as well.

REMARK 4.5.2. By comparison to the *nonarchimedean* case treated in §3, *certain* — but *not all!* — of the “arrows” that appear in the archimedean case go in the *opposite* direction to the nonarchimedean case. This is somewhat reminiscent of the “product formula” in elementary number theory, where, for instance, positive powers of prime numbers  $\rightarrow 0$  at nonarchimedean primes, but  $\rightarrow \infty$  at archimedean primes. In the context of Corollary 4.5, perhaps the most important example of this phenomenon is given by “ $\underline{\lambda}_x$ ”. This leads to a somewhat different structure for the *observable*  $\mathfrak{S}_{\log}$  of Corollary 4.5, (iii) — involving “archimedean” homotopies of arbitrarily large “length” (cf. the “non- $[\gamma]$ -portion” of the pairs of paths of types (1), (2), (3), (4) in the proof of Corollary 4.5, (iii)) — from the structure of the observable  $\mathfrak{S}_{\log}$  of Corollary 3.6, (iii) — which involves “nonarchimedean” paths of bounded “length” (cf. the “non- $[\gamma]$ -portion” of the pairs of paths of types (1), (2) in the proof of Corollary 3.6, (iii)).

REMARK 4.5.3.

(i) By *replacing*

$$\begin{aligned} \text{“}\lambda^{\times\text{pf}}\text{”} & \quad \text{by} \quad \text{“}\lambda^{\sim}\text{”}, \\ \text{“}\underline{\lambda}_x = \lambda_x : \lambda^{\times} \rightarrow \lambda^{\times\text{pf}}\text{”} & \quad \text{by} \quad \text{“}\underline{\lambda}_x = \lambda_x : \lambda^{\sim} \rightarrow \lambda^{\times}\text{”}, \text{ and} \\ \text{“Corollary 1.10”} & \quad \text{by} \quad \text{“Corollary 2.7”}, \end{aligned}$$

(and making various other suitable revisions) one obtains an essentially straightforward “Aut-holomorphic translation” of the *bi-anabelian incompatibility* result given in Corollary 3.7. We leave the routine details to the reader.

(ii) The “*general formal content*” of Remarks 3.7.1, 3.7.2, 3.7.3, 3.7.4, 3.7.5, 3.7.7, and 3.7.8 applies to the *archimedean analogue* of Corollary 3.7 discussed in (i) — cf. also the analogy of Remark 2.7.3; the discussion in Remark 2.7.4 of “*fixed reference models*” in the context of the definition of the notion of a “*holomorphic structure*”.

(iii) With regard to the discussion in Remark 3.7.4 of “*functorially trivial models*” (i.e., models that “arise from  $\Pi$ ” without essential use of  $\Pi$ , hence

are equipped with *trivial* functorial actions of  $\Pi$ ), we note that although “the Galois group  $\Pi$ ” does not appear in the present *archimedean* context, the “*functorial detachment*” of such “functorially trivial models” means, for instance, that if one regards some model  $\mathbb{X}_{\text{model}}$  as “*arising*” from an elliptically admissible Aut-holomorphic orbispace  $\mathbb{X}$  in a “trivial fashion”, then when one applies the “*elliptic cuspidalization*” portion of the *algorithm* of Corollary 2.7, (b), the various coverings of  $\mathbb{X}$  involved in this elliptic cuspidalization algorithm *functorially induce trivial coverings* of  $\mathbb{X}_{\text{model}}$ , hence do not give rise to a *functorial isomorphism* of the respective “base fields” (cf. Remark 2.7.3) of  $\mathbb{X}$ ,  $\mathbb{X}_{\text{model}}$ .

(iv) With regard to the discussion in Remark 3.7.5, one may give an *archimedean* analogue of the “*pathological versions of the Kummer map*” given in Remark 3.7.5, (ii), by composing the *k-Kummer structure* (cf. Definition 4.1, (i)) “ $\kappa_k : k \xrightarrow{\sim} \overline{\mathcal{A}}_{\mathbb{X}_{\text{ell}}}$ ”, restricted, say, to  $k^\times$ , with the (*non-additive!*) automorphism of

$$k^\times \xrightarrow{\sim} \mathcal{O}_k^\times \times \mathbb{R}_{>0}$$

that acts as the identity on  $\mathcal{O}_k^\times$  and is given by *raising to the  $\lambda$ -th power* (for some  $\lambda \in \mathbb{R}_{>0}$ ) on  $\mathbb{R}_{>0}$ .

## Section 5. Global Log-Frobenius Compatibility

In the present §5, we *globalize* the theory of §3, §4. This globalization allows one to construct *canonical rigid compacta* — i.e., *canonical integral structures* — that enable one to consider (“*pana-*”)localizations of *global arithmetic line bundles* (cf. Corollary 5.5) without obliterating the “*volume-theoretic*” information inherent in the theory of global arithmetic degrees, and in a fashion that is compatible with the operation of “*mono-analyticization*” (cf. Corollary 5.10) — i.e., the operation of “*disabling the rigidity*” of one of the “*two combinatorial dimensions*” of a ring (cf. Remark 5.6.1). The resulting theory is reminiscent, in certain formal respects, of the *p-adic Teichmüller theory* of [Mzk1], [Mzk4] (cf. Remark 5.10.3).

### DEFINITION 5.1.

(i) Let  $F$  be a *number field*. Then we shall write  $\mathbb{V}(F)$  for the set of (archimedean and nonarchimedean) *valuations* of  $F$ , and  $\mathbb{V}^\circledast(F) \stackrel{\text{def}}{=} \mathbb{V}(F)$

$\mathbb{V}(F) \cup \{\odot_F\}$ , where the symbol “ $\odot_F$ ” is to be thought of as representing the *global field*  $F$ , or, alternatively, the *generic prime* of  $F$ . If  $\overline{F}$  is an *algebraic closure* of  $F$ , then we shall write

$$\mathbb{V}(\overline{F}/F) \stackrel{\text{def}}{=} \varprojlim_K \mathbb{V}(K); \quad \mathbb{V}^\odot(\overline{F}/F) \stackrel{\text{def}}{=} \varprojlim_K \mathbb{V}^\odot(K)$$

(where  $K$  ranges over the finite extensions of  $F$  in  $\overline{F}$ ) for the inverse limits relative to the evident systems of morphisms. The inverse system of “ $\odot_K$ ’s” determines a unique *global element*  $\odot_{\overline{F}} \in \mathbb{V}^\odot(\overline{F}/F)$ ; the other elements of  $\mathbb{V}^\odot(\overline{F}/F)$  lie in the image of the natural injection  $\mathbb{V}(\overline{F}/F) \hookrightarrow \mathbb{V}^\odot(\overline{F}/F)$  and will be called *local*; moreover, we have a natural decomposition

$$\mathbb{V}(\overline{F}/F) = \mathbb{V}(\overline{F}/F)^{\text{arc}} \cup \mathbb{V}(\overline{F}/F)^{\text{non}}$$

into *archimedean* and *nonarchimedean* local elements. There is a *natural continuous action* of  $\text{Gal}(\overline{F}/F)$  on the pro-sets  $\mathbb{V}(\overline{F}/F)$ ,  $\mathbb{V}^\odot(\overline{F}/F)$ . For  $K \subseteq \overline{F}$  a finite extension of  $F$ ,  $\mathbb{V}(K)$ ,  $\mathbb{V}^\odot(K)$  may be identified, respectively, with the sets of  $\text{Gal}(\overline{F}/K) (\subseteq \text{Gal}(\overline{F}/F))$ -*orbits*  $\mathbb{V}(\overline{F}/F)/\text{Gal}(\overline{F}/K)$ ,  $\mathbb{V}^\odot(\overline{F}/F)/\text{Gal}(\overline{F}/K)$  of  $\mathbb{V}(\overline{F}/F)$ ,  $\mathbb{V}^\odot(\overline{F}/F)$ .

(ii) Let  $X$  be an *elliptically admissible* (cf. [Mzk21], Definition 3.1) *hyperbolic orbicurve* over a *totally imaginary number field*  $F$  (so  $X$  is also of *strictly Belyi type* — cf. Remark 2.8.3). Write  $\Pi_X$  for the *étale fundamental group* of  $X$  (for some choice of basepoint);  $\Pi_X \twoheadrightarrow G_F \stackrel{\text{def}}{=} \text{Gal}(\overline{F}/F)$  for the natural surjection onto the absolute Galois group  $G_F$  of  $F$  (for some choice of algebraic closure  $\overline{F}$  of  $F$ );  $\Delta_X \subseteq \Pi_X$  for the kernel of this surjection (which may be characterized “group-theoretically” as the *maximal topologically finite generated closed normal subgroup* of  $\Pi_X$  — cf., e.g., [Mzk9], Lemma 1.1.4, (i)). Write

$$F^{\text{mod}} \subseteq \overline{F}$$

for the “*field of moduli of X*”, i.e., the subfield of  $F$  determined by the (open) image of  $\text{Aut}(X_{\overline{F}})$  (i.e., the group of automorphisms of the scheme  $X_{\overline{F}} \stackrel{\text{def}}{=} X \times_F \overline{F}$ ) in  $\text{Aut}(\overline{F}) = \text{Gal}(\overline{F}/\mathbb{Q}) (\supseteq G_F)$ ;  $\text{Aut}(X)$ ,  $\text{Aut}(F)$  for the respective automorphism groups of the schemes  $X$ ,  $\text{Spec}(F)$ . For simplicity, we also make the following *assumption on X*:

$F$  is Galois over  $F^{\text{mod}}$ ; the natural homomorphism  $\text{Aut}(X) \rightarrow \text{Aut}(F)$  surjects onto  $\text{Gal}(F/F^{\text{mod}})$  ( $\subseteq \text{Aut}(F)$ ); we have a natural isomorphism

$$\text{Aut}(X/F) \xrightarrow{\sim} \text{Aut}(X_{\overline{F}}/\overline{F})$$

between the group of  $F$ -automorphisms of  $X$  and the group of  $\overline{F}$ -automorphisms of  $X_{\overline{F}}$ .

This assumption on  $X$  implies that we have a natural isomorphism

$$\text{Aut}(X) \times_{\text{Gal}(F/F^{\text{mod}})} \text{Gal}(\overline{F}/F^{\text{mod}}) \xrightarrow{\sim} \text{Aut}(X_{\overline{F}})$$

(induced by the fiber product structure  $X_{\overline{F}} = X \times_F \overline{F}$ ), and hence that the natural exact sequence  $1 \rightarrow \text{Aut}(X_{\overline{F}}/\overline{F}) \rightarrow \text{Aut}(X_{\overline{F}}) \rightarrow \text{Gal}(\overline{F}/F^{\text{mod}}) \rightarrow 1$  admits a natural surjection onto the natural exact sequence

$$1 \rightarrow \text{Aut}(X/F) \rightarrow \text{Aut}(X) \rightarrow \text{Gal}(F/F^{\text{mod}}) \rightarrow 1$$

(induced by the projection  $\text{Aut}(X) \times_{\text{Gal}(F/F^{\text{mod}})} \text{Gal}(\overline{F}/F^{\text{mod}}) \rightarrow \text{Aut}(X)$  to the first factor). Note that by the functoriality of the algorithms of Theorem 1.9, it follows that there is a natural isomorphism  $\text{Aut}(X) \xrightarrow{\sim} \text{Out}(\Pi_X)$  that is compatible with the natural morphisms  $\text{Aut}(X) \rightarrow \text{Gal}(F/F^{\text{mod}}) \hookrightarrow \text{Aut}(F) \cong \text{Out}(G_F)$  (cf., e.g., [Mzk15], Theorem 3.1),  $\text{Out}(\Pi_X) \rightarrow \text{Out}(G_F)$ ; in particular, one may functorially construct the image  $G_{F^{\text{mod}}} \hookrightarrow \text{Aut}(G_F)$  as the inverse image (i.e., via the natural projection  $\text{Aut}(G_F) \rightarrow \text{Out}(G_F)$ ) of the image of  $\text{Out}(\Pi_X) \rightarrow \text{Out}(G_F)$ . Next, observe that one may functorially construct “ $\overline{F}$ ” from  $\Pi_X$  as the field “ $\overline{k}_{\text{NF}}^\times \cup \{0\}$  ( $\cong \overline{k}_{\text{NF}}$ )” constructed in Theorem 1.9, (e) (cf. also Remark 1.10.1, (i)); denote this field constructed from  $\Pi_X$  by  $\overline{k}_{\text{NF}}(\Pi_X)$ ; we shall also use the notation  $\overline{k}_{\text{NF}}^\times(\Pi_X)$  for the group of nonzero elements of this field. In particular, by considering (cf. Corollary 2.8) valuations on the field  $\overline{k}_{\text{NF}}(\Pi_X)$  (where each valuation is valued in the “copy of  $\mathbb{R}$ ” given by completing the group “ $\overline{k}_{\text{NF}}^\times$ ” with respect to the “order topology” determined by the valuation), one may functorially construct “ $\mathbb{V}^\circ(\overline{F}/F)$ ”, “ $\mathbb{V}(\overline{F}/F)$ ” from  $\Pi_X$ ; denote the resulting pro-sets constructed in this way by  $\mathbb{V}^\circ(\Pi_X)$ ,  $\mathbb{V}(\Pi_X)$  and the completion of  $\overline{k}_{\text{NF}}(\Pi_X)$  at  $\overline{v} \in \mathbb{V}(\Pi_X)$  by  $\overline{k}_{\text{NF}}(\Pi_X, \overline{v})$ . For  $\overline{v} \in \mathbb{V}(\overline{F}/F)^{\text{non}}$ , write

$$\Pi_{X, \overline{v}} \subseteq \Pi_X$$



for the *decomposition group* of  $\bar{v}$  (i.e., the closed subgroup of elements of  $\Pi_X$  that fix  $\bar{v}$ ); for  $\bar{v} \in \mathbb{V}(\bar{F}/F)^{\text{arc}}$ , write

$$\mathbb{X}_{\text{ell},\bar{v}}$$

for the *Aut-holomorphic orbispace* “ $\mathbb{X}_{\bar{v}}$ ” (associated to  $X$  at  $\bar{v}$ ) of Corollary 2.8,

$$\delta_{\text{ell},\bar{v}} : \Delta_X \xrightarrow{\sim} \pi_1(\mathbb{X}_{\text{ell},\bar{v}})^\wedge$$

for the *natural outer isomorphism* of  $\Delta_X$  with the profinite completion (denoted by the superscript “ $\wedge$ ”) of the topological fundamental group of  $\mathbb{X}_{\text{ell},\bar{v}}$ , and

$$\kappa_{\text{ell},\bar{v}} : \bar{k}_{\text{NF}}(\Pi_X) \hookrightarrow \bar{\mathcal{A}}_{\mathbb{X}_{\text{ell},\bar{v}}}$$

for the *natural inclusion of fields* (i.e., arising from the isomorphism of topological fields of Corollary 2.9, (b)). When we wish to regard  $\mathbb{X}_{\text{ell},\bar{v}}$  as an object *constructed from*  $\Pi_X$  (cf. Corollary 2.8), we shall use the notation  $\mathbb{X}(\Pi_X, \bar{v})$  (where we regard  $\bar{v}$  as an element of  $\mathbb{V}(\Pi_X)^{\text{arc}}$ ). Finally, we observe that  $\text{Aut}(\Pi_X)$  *acts naturally* on all of these objects constructed from  $\Pi_X$ . In particular, we have a *natural bijection*  $\mathbb{V}^\circ(\Pi_X)/\text{Aut}(\Pi_X) \xrightarrow{\sim} \mathbb{V}^\circ(F^{\text{mod}})$ . For  $v \in \mathbb{V}(F^{\text{mod}})$ , write  $d_v^{\text{mod}} \stackrel{\text{def}}{=} [F_{v_F} : (F^{\text{mod}})_v]$  for the degree of the completion of  $F$  at any  $v_F \in \mathbb{V}(F)$  that divides  $v$  over the completion  $(F^{\text{mod}})_v$  of  $F^{\text{mod}}$  at  $v$ .

(iii) Write

$$\mathbb{EA}^\circ$$

for the category whose objects are *profinite groups* isomorphic to  $\Pi_X$  for some  $X$  as in (ii), and whose morphisms are *open injections* of profinite groups that induce *isomorphisms* between the respective maximal topologically finitely generated closed normal subgroups (i.e., the respective “ $\Delta_X$ ”). We shall refer to as a *global Galois-theater* any collection of data

$$\mathcal{V}^\circ \stackrel{\text{def}}{=} (\Pi \curvearrowright \bar{V}^\circ, \{\Pi_{\bar{v}}\}_{\bar{v} \in \bar{V}^{\text{non}}}, \{(\mathbb{X}_{\bar{v}}, \delta_{\bar{v}}, \kappa_{\bar{v}})\}_{\bar{v} \in \bar{V}^{\text{arc}}})$$

— where  $\Pi \in \text{Ob}(\mathbb{EA}^\circ)$ ; we shall refer to  $\Pi$  as the *global Galois group* of the Galois-theater; we write  $\Delta \subseteq \Pi$  for the *maximal topologically finitely generated closed normal subgroup* of  $\Pi$ ;  $\bar{V}^\circ$  is a *pro-set* equipped with a *continuous action* by  $\Pi$  that decomposes into a disjoint union  $\bar{V}^\circ = \{\circlearrowleft_{\bar{v}}\} \cup \bar{V}^{\text{non}} \cup \bar{V}^{\text{arc}} \supseteq \bar{V} \stackrel{\text{def}}{=} \bar{V}^{\text{non}} \cup \bar{V}^{\text{arc}}$ ; for  $\bar{v} \in \bar{V}^{\text{non}}$ ,  $\Pi_{\bar{v}} \subseteq \Pi$  is the

closed subgroup of elements that fix  $\bar{v}$ ; for  $\bar{v} \in \bar{V}^{\text{arc}}$ ,  $\mathbb{X}_{\bar{v}}$  is an Aut-holomorphic orbispace,  $\delta_{\bar{v}} : \Delta \xrightarrow{\sim} \pi_1(\mathbb{X}_{\bar{v}})^\wedge$  is an outer isomorphism of profinite groups, and  $\kappa_{\bar{v}} : \bar{k}_{\text{NF}}(\Pi) \hookrightarrow \bar{\mathcal{A}}_{\mathbb{X}_{\bar{v}}}$  is an inclusion of fields — such that there exists a(n) (*unique!* — cf. Remark 5.1.1 below) *isomorphism of pro-sets*

$$\psi_{\bar{V}} : \mathbb{V}^\circ(\Pi) \xrightarrow{\sim} \bar{V}^\circ$$

— which we shall refer to as a *reference isomorphism* for  $\mathbb{V}^\circ$  — that satisfies the following conditions: (a)  $\psi_{\bar{V}}$  is  $\Pi$ -equivariant and maps  $\circlearrowleft_{\bar{k}_{\text{NF}}(\Pi)} \mapsto \circlearrowleft_{\bar{V}}$ ,  $\mathbb{V}^\circ(\Pi)^{\text{non}} \xrightarrow{\sim} \bar{V}^{\text{non}}$ ,  $\mathbb{V}^\circ(\Pi)^{\text{arc}} \xrightarrow{\sim} \bar{V}^{\text{arc}}$ ; (b) for  $\mathbb{V}^\circ(\Pi)^{\text{arc}} \ni \bar{v}_{\text{ell}} \mapsto \bar{v} \in \bar{V}^{\text{arc}}$ , there exists a(n) (*unique!* — cf. Remark 5.1.1 below) isomorphism  $\psi_{\bar{v}} : \mathbb{X}(\Pi, \bar{v}_{\text{ell}}) \xrightarrow{\sim} \mathbb{X}_{\bar{v}}$  of Aut-holomorphic spaces that is *compatible* with  $\delta_{\text{ell}, \bar{v}_{\text{ell}}}$ ,  $\delta_{\bar{v}}$ , as well as with  $\kappa_{\text{ell}, \bar{v}_{\text{ell}}}$ ,  $\kappa_{\bar{v}}$ . A *morphism of global Galois-theaters*

$$\begin{aligned} \phi : (\Pi_1 \curvearrowright \bar{V}_1^\circ, \{(\Pi_1)_{\bar{v}_1}\}, \{((\mathbb{X}_1)_{\bar{v}_1}, \delta_{\bar{v}_1}, \kappa_{\bar{v}_1})\}) \\ \rightarrow (\Pi_2 \curvearrowright \bar{V}_2^\circ, \{(\Pi_2)_{\bar{v}_2}\}, \{((\mathbb{X}_2)_{\bar{v}_2}, \delta_{\bar{v}_2}, \kappa_{\bar{v}_2})\}) \end{aligned}$$

is defined to consist of a *morphism*  $\phi_\Pi : \Pi_1 \hookrightarrow \Pi_2$  of  $\mathbb{EA}^\circ$  and a(n) (*uniquely* determined — cf. Remark 5.1.1 below) *isomorphism of pro-sets*  $\phi_{\bar{V}} : \bar{V}_1^\circ \xrightarrow{\sim} \bar{V}_2^\circ$  that satisfy the following conditions: (a)  $\phi_\Pi$ ,  $\phi_{\bar{V}}$  are *compatible* with the actions of  $\Pi_1$ ,  $\Pi_2$  on  $\bar{V}_1^\circ$ ,  $\bar{V}_2^\circ$ , and map  $\circlearrowleft_{\bar{V}_1} \mapsto \circlearrowleft_{\bar{V}_2}$ ,  $\bar{V}_1^{\text{non}} \xrightarrow{\sim} \bar{V}_2^{\text{non}}$ ,  $\bar{V}_1^{\text{arc}} \xrightarrow{\sim} \bar{V}_2^{\text{arc}}$ ; (b) for  $\bar{V}_1^{\text{arc}} \ni \bar{v}_1 \mapsto \bar{v}_2 \in \bar{V}_2^{\text{arc}}$ , there exists a (*unique!* — cf. Remark 5.1.1 below) isomorphism  $\phi_{\bar{v}} : \mathbb{X}_{\bar{v}_1} \xrightarrow{\sim} \mathbb{X}_{\bar{v}_2}$  of Aut-holomorphic spaces that is *compatible* with  $\delta_{\bar{v}_1}$ ,  $\delta_{\bar{v}_2}$ , as well as with  $\kappa_{\bar{v}_1}$ ,  $\kappa_{\bar{v}_2}$ . (Here, we note that (a) implies that for  $\bar{V}_1^{\text{non}} \ni \bar{v}_1 \mapsto \bar{v}_2 \in \bar{V}_2^{\text{non}}$ ,  $\phi_\Pi$  induces an open injection  $\phi_{\bar{v}} : \Pi_{\bar{v}_1} \hookrightarrow \Pi_{\bar{v}_2}$ .)

(iv) In the notation of (iii), we shall refer to as a *panalocal Galois-theater* any collection of data

$$\mathcal{V}^\star \stackrel{\text{def}}{=} (V^\circ, \{\Pi_v\}_{v \in V^{\text{non}}}, \{\mathbb{X}_v\}_{v \in V^{\text{arc}}})$$

— where  $V^\circ$  is a set that decomposes as a disjoint union  $V^\circ = \{\circlearrowleft_V\} \cup V^{\text{non}} \cup V^{\text{arc}} \supseteq V \stackrel{\text{def}}{=} V^{\text{non}} \cup V^{\text{arc}}$ ; for  $v \in V^{\text{non}}$ ,  $\Pi_v \in \text{Ob}(\text{Orb}(\text{TG}))$  (cf. §0; Definition 3.1, (iii)); for  $v \in V^{\text{arc}}$ ,  $\mathbb{X}_v \in \text{Ob}(\text{Orb}(\mathbb{EA}))$  (cf. Definition 4.1, (iii)) — such that there exists a  $\Pi \in \text{Ob}(\mathbb{EA}^\circ)$  and an *isomorphism of sets*

$$\psi_V : \mathbb{V}^\circ(\Pi)/\text{Aut}(\Pi) \xrightarrow{\sim} V^\circ$$

— which we shall refer to as a *reference isomorphism* for  $\mathcal{V}^{\star}$  — that satisfies the following conditions: (a) the composite of  $\psi_V$  with the quotient map  $\mathbb{V}^{\circ}(\Pi) \rightarrow \mathbb{V}^{\circ}(\Pi)/\text{Aut}(\Pi)$  maps  $\odot_{\bar{k}_{\text{NF}}(\Pi)} \mapsto \odot_V, \mathbb{V}(\Pi)^{\text{non}} \rightarrow V^{\text{non}}, \mathbb{V}(\Pi)^{\text{arc}} \rightarrow V^{\text{arc}}$ ; (b) for each  $v \in V^{\text{non}}, \Pi_v$  is isomorphic to the object of  $\text{Orb}(\text{TTG})$  determined by “the *decomposition group*  $\Pi_{\bar{v}} \subseteq \Pi$  of  $\bar{v}$ , considered up to *automorphisms* of  $\Pi_{\bar{v}}$ , as  $\bar{v} \in \mathbb{V}(\Pi)$  ranges over the elements lying over  $v$ ”; (c) for each  $v \in V^{\text{arc}}, \mathbb{X}_v$  is isomorphic to the object of  $\text{Orb}(\mathbb{EA})$  determined by “the *Aut-holomorphic orbispace*  $\mathbb{X}(\Pi, \bar{v})$ , considered up to *automorphisms* of  $\mathbb{X}(\Pi, \bar{v})$ , as  $\bar{v} \in \mathbb{V}(\Pi)$  ranges over the elements lying over  $v$ ”. A *morphism of panalocal Galois-theaters*

$$\phi : (V_1^{\circ}, \{(\Pi_1)_{v_1}\}, \{(\mathbb{X}_1)_{v_1}\}) \rightarrow (V_2^{\circ}, \{(\Pi_2)_{v_2}\}, \{(\mathbb{X}_2)_{v_2}\})$$

is defined to consist of a bijection of sets  $\phi_V : V_1^{\circ} \xrightarrow{\sim} V_2^{\circ}$  that induces bijections  $V_1^{\text{non}} \xrightarrow{\sim} V_2^{\text{non}}, V_1^{\text{arc}} \xrightarrow{\sim} V_2^{\text{arc}}$ , together with open injections of (orbi-)profinite groups  $(\Pi_1)_{v_1} \hookrightarrow (\Pi_2)_{v_2}$  (where  $V_1^{\text{non}} \ni v_1 \mapsto v_2 \in V_2^{\text{non}}$ ; we recall that, in the notation of (ii), “ $F/F^{\text{mod}}$ ” is *Galois*), and isomorphisms of (orbi-)Aut-holomorphic orbispaces  $(\mathbb{X}_1)_{v_1} \xrightarrow{\sim} (\mathbb{X}_2)_{v_2}$  (where  $V_1^{\text{arc}} \ni v_1 \mapsto v_2 \in V_2^{\text{arc}}$ ). (Here, we observe that the existence of the isomorphisms “ $(\mathbb{X}_1)_{v_1} \xrightarrow{\sim} (\mathbb{X}_2)_{v_2}$ ” implies — by considering *Euler characteristics* (cf. also [Mzk20], Theorem 2.6, (v)) — that the open injections “ $(\Pi_1)_{v_1} \hookrightarrow (\Pi_2)_{v_2}$ ” induce isomorphisms “ $\Delta_1 \xrightarrow{\sim} \Delta_2$ ” between the respective geometric fundamental groups.) Write  $\mathfrak{H}^{\circ}$  (respectively,  $\mathfrak{H}^{\star}$ ) for the category of *global* (respectively, *panalocal*) *Galois-theaters* and morphisms of global (respectively, panalocal) Galois-theaters. Thus, it follows immediately from the definitions that we obtain a natural “*panalocalization functor*”

$$\mathfrak{H}^{\circ} \rightarrow \mathfrak{H}^{\star}$$

— which is *essentially surjective*.

(v) Let  $\mathbb{T} \in \{\text{TF}, \text{TM}, \text{TLG}\}$  (cf. the notation of Definition 3.1, (i)). If  $\mathbb{T} = \text{TF}$ , then let  $\mathbb{T}^{\circ} \stackrel{\text{def}}{=} \mathbb{T}$ ; if  $\mathbb{T} \neq \text{TF}$ , then let  $\mathbb{T}^{\circ} \stackrel{\text{def}}{=} \text{TLG}$ ; if  $\mathbb{T}^{\circ} \neq \mathbb{T}$ , then a superscript “ $\mathbb{T}^{\circ}$ ” will be used to denote the operation of *groupification of a monoid* (i.e., “gp”); if  $\mathbb{T}^{\circ} = \mathbb{T}$ , then a superscript “ $\mathbb{T}^{\circ}$ ” will be used to denote the “identity operation” (i.e., may be ignored). If  $\Pi \in \text{Ob}(\mathbb{EA}^{\circ})$ , then let us write  $M_{\mathbb{T}^{\circ}}(\Pi)$  for the object of  $\mathbb{T}^{\circ}$ , equipped with a continuous action by  $\Pi$ , determined by  $\bar{k}_{\text{NF}}(\Pi)$  (if  $\mathbb{T}^{\circ} = \text{TF}$ ),  $\bar{k}_{\text{NF}}^{\times}(\Pi)$  (if  $\mathbb{T}^{\circ} = \text{TLG}$ ),

equipped with the *discrete topology*; if  $\bar{v} \in \mathbb{V}(\Pi)$ , then let us write  $M_{\mathbb{T}}(\Pi, \bar{v})$  for the object of  $\mathbb{T}$ , equipped with a continuous action by the decomposition group  $\Pi_{\bar{v}} \subseteq \Pi$  of  $\bar{v}$ , determined by  $\bar{k}_{\text{NF}}(\Pi, \bar{v})$  (if  $\mathbb{T}^{\circ} = \mathbb{T}\mathbb{F}$ ),  $\bar{k}_{\text{NF}}^{\times}(\Pi, \bar{v})$  (if  $\mathbb{T}^{\circ} = \mathbb{T}\text{LG}$ ),  $\mathcal{O}_{\bar{k}_{\text{NF}}(\Pi, \bar{v})}^{\triangleright}$  (if  $\mathbb{T}^{\circ} = \mathbb{T}\mathbb{M}$ ). A *global  $\mathbb{T}$ -pair* is defined to be a collection of data

$$\mathcal{M}^{\circ} \stackrel{\text{def}}{=} (\mathcal{V}^{\circ}, M^{\circ}, \{\rho_{\bar{v}}\}_{\bar{v} \in \bar{V}}, \{(\Pi_{\bar{v}} \curvearrowright M_{\bar{v}})\}_{\bar{v} \in \bar{V}^{\text{non}}}, \{(\mathbb{X}_{\bar{v}} \overset{\kappa}{\curvearrowright} M_{\bar{v}})\}_{\bar{v} \in \bar{V}^{\text{arc}}})$$

— where

$$\mathcal{V}^{\circ} = (\Pi \curvearrowright \bar{V}^{\circ}, \{\Pi_{\bar{v}}\}_{\bar{v} \in \bar{V}^{\text{non}}}, \{(\mathbb{X}_{\bar{v}}, \delta_{\bar{v}}, \kappa_{\bar{v}})\}_{\bar{v} \in \bar{V}^{\text{arc}}})$$

is a *global Galois-theater*;  $\bar{V} = \bar{V}^{\text{non}} \cup \bar{V}^{\text{arc}}$ ;  $M^{\circ} \in \text{Ob}(\mathbb{T}^{\circ})$ , which we shall refer to as the *global arithmetic data* of  $\mathcal{M}^{\circ}$ , is equipped with a *continuous action by  $\Pi$* ; for each  $\bar{v} \in \bar{V}^{\text{non}}$ ,  $(\Pi_{\bar{v}} \curvearrowright M_{\bar{v}})$  is an *MLF-Galois  $\mathbb{T}$ -pair* with Galois group given by  $\Pi_{\bar{v}}$ ; for each  $\bar{v} \in \bar{V}^{\text{arc}}$ ,  $(\mathbb{X}_{\bar{v}} \overset{\kappa}{\curvearrowright} M_{\bar{v}})$  is an *Aut-holomorphic  $\mathbb{T}$ -pair* with structure-orbispaces given by  $\mathbb{X}_{\bar{v}}$ ; for each  $\bar{v} \in \bar{V}$ ,  $\rho_{\bar{v}} : M^{\circ} \rightarrow M_{\bar{v}}^{\mathbb{T}^{\circ}}$  is a (“restriction”) morphism in  $\mathbb{T}^{\circ}$  — such that, relative to some *reference isomorphism*  $\psi_{\bar{V}} : \mathbb{V}^{\circ}(\Pi) \xrightarrow{\sim} \bar{V}^{\circ}$  for  $\mathcal{V}^{\circ}$  as in (iii), there exist *isomorphisms* (in  $\mathbb{T}^{\circ}$ ,  $\mathbb{T}$ , respectively)

$$\psi^{\circ} : M_{\mathbb{T}^{\circ}}(\Pi) \xrightarrow{\sim} M^{\circ}; \quad \{\psi_{\bar{v}} : M_{\mathbb{T}}(\Pi, \bar{v}) \xrightarrow{\sim} M_{\bar{v}}\}_{\bar{v} \in \bar{V}}$$

— which we shall refer to as *reference isomorphisms* for  $\mathcal{M}^{\circ}$  — that satisfy the following conditions: (a)  $\psi^{\circ}$  is  $\Pi$ -equivariant; (b) for  $\bar{v} \in \bar{V}^{\text{non}}$ ,  $\psi_{\bar{v}}$  is  $\Pi_{\bar{v}}$ -equivariant; (c) for  $\bar{v} \in \bar{V}^{\text{arc}}$ , the composite of  $\psi_{\bar{v}}$  with the *Kummer structure* of  $(\mathbb{X}_{\bar{v}} \overset{\kappa}{\curvearrowright} M_{\bar{v}})$  is compatible with  $\kappa_{\bar{v}}$ ; (d)  $\psi^{\circ}, \{\psi_{\bar{v}}\}_{\bar{v} \in \bar{V}}$  are compatible with the  $\{\rho_{\bar{v}}\}_{\bar{v} \in \bar{V}}$ , relative to the natural restriction morphisms  $\rho_{\bar{v}}(\Pi) : M_{\mathbb{T}^{\circ}}(\Pi) \rightarrow M_{\mathbb{T}}(\Pi, \bar{v})^{\mathbb{T}^{\circ}}$ . In this situation, if  $\mathbb{T} \neq \mathbb{T}\mathbb{F}$ , then we shall refer to the profinite  $\Pi$ -module

$$\boldsymbol{\mu}_{\widehat{\mathbb{Z}}}(M^{\circ}) \stackrel{\text{def}}{=} \text{Hom}(\mathbb{Q}/\mathbb{Z}, M^{\circ})$$

(which is isomorphic to  $\widehat{\mathbb{Z}}$ ) as the *cyclotome* associated to this global  $\mathbb{T}$ -pair and write  $\boldsymbol{\mu}_{\mathbb{Q}/\mathbb{Z}}(M^{\circ}) \stackrel{\text{def}}{=} \boldsymbol{\mu}_{\widehat{\mathbb{Z}}}(M^{\circ}) \otimes \mathbb{Q}/\mathbb{Z}$ . A *morphism of global  $\mathbb{T}$ -pairs*

$$\begin{aligned} \phi : (\mathcal{V}_1^{\circ}, M_1^{\circ}, \{\rho_{\bar{v}_1}\}, \{((\Pi_1)_{\bar{v}_1} \curvearrowright (M_1)_{\bar{v}_1})\}, \{((\mathbb{X}_1)_{\bar{v}_1} \overset{\kappa}{\curvearrowright} (M_1)_{\bar{v}_1})\}) \\ \rightarrow (\mathcal{V}_2^{\circ}, M_2^{\circ}, \{\rho_{\bar{v}_2}\}, \{((\Pi_2)_{\bar{v}_2} \curvearrowright (M_2)_{\bar{v}_2})\}, \{((\mathbb{X}_2)_{\bar{v}_2} \overset{\kappa}{\curvearrowright} (M_2)_{\bar{v}_2})\}) \end{aligned}$$

is defined to consist of a *morphism of global Galois-theaters*  $\phi_{\mathcal{V}^\circ} : \mathcal{V}_1^\circ \rightarrow \mathcal{V}_2^\circ$ , together with an *isomorphism*  $\phi^\circ : M_1^\circ \xrightarrow{\sim} M_2^\circ$  of  $\mathbb{T}^\circ$ , and *isomorphisms*  $\phi_{\bar{v}_1} : (M_1)_{\bar{v}_1} \xrightarrow{\sim} (M_2)_{\bar{v}_2}$  (where  $\bar{V}_1 \ni \bar{v}_1 \mapsto \bar{v}_2 \in \bar{V}_2$ ) in  $\mathbb{T}$ , that satisfy the following *compatibility* conditions: (a)  $\phi^\circ$  is *equivariant* with respect to the open injection  $\Pi_1 \hookrightarrow \Pi_2$  arising from  $\phi_{\mathcal{V}^\circ}$ ; (b) for  $\bar{v}_1 \in \bar{V}_1^{\text{non}}$ , the isomorphism  $\phi_{\bar{v}_1}$  is *compatible* with the actions of  $(\Pi_1)_{\bar{v}_1}$ ,  $(\Pi_2)_{\bar{v}_2}$ , relative to the open injection  $(\Pi_1)_{\bar{v}_1} \hookrightarrow (\Pi_2)_{\bar{v}_2}$  induced by  $\phi_{\mathcal{V}^\circ}$ ; (c) for  $\bar{v}_1 \in \bar{V}_1^{\text{arc}}$ , the isomorphism  $\phi_{\bar{v}_1}$  is *compatible* with the Kummer structures of  $((\mathbb{X}_1)_{\bar{v}_1} \overset{\kappa}{\curvearrowright} (M_1)_{\bar{v}_1})$ ,  $((\mathbb{X}_2)_{\bar{v}_2} \overset{\kappa}{\curvearrowright} (M_2)_{\bar{v}_2})$ , relative to the isomorphism  $(\mathbb{X}_1)_{\bar{v}_1} \xrightarrow{\sim} (\mathbb{X}_2)_{\bar{v}_2}$  induced by  $\phi_{\mathcal{V}^\circ}$ ; (d)  $\phi^\circ$ ,  $\{\phi_{\bar{v}_1}\}_{\bar{v}_1 \in \bar{V}_1}$  are *compatible* with the  $\{\rho_{\bar{v}_1}\}_{\bar{v}_1 \in \bar{V}_1}$ ,  $\{\rho_{\bar{v}_2}\}_{\bar{v}_2 \in \bar{V}_2}$ .

(vi) In the notation of (v), a *panalocal  $\mathbb{T}$ -pair* is defined to be a collection of data

$$\mathcal{M}^{\star} \stackrel{\text{def}}{=} (\mathcal{V}^{\star}, \{(\Pi_v \curvearrowright M_v)\}_{v \in V^{\text{non}}}, \{(\mathbb{X}_v \overset{\kappa}{\curvearrowright} M_v)\}_{v \in V^{\text{arc}}})$$

— where  $\mathcal{V}^{\star} = (V^\circ, \{\Pi_v\}_{v \in V^{\text{non}}}, \{\mathbb{X}_v\}_{v \in V^{\text{arc}}})$  is a *panalocal Galois-theater*; for each  $v \in V^{\text{non}}$ ,  $(\Pi_v \curvearrowright M_v)$  is a(n) (strictly speaking, “orbi-”) *MLF-Galois  $\mathbb{T}$ -pair* with Galois group given by  $\Pi_v$ ; for each  $v \in V^{\text{arc}}$ ,  $(\mathbb{X}_v \overset{\kappa}{\curvearrowright} M_v)$  is a(n) (strictly speaking, “orbi-”) *Aut-holomorphic  $\mathbb{T}$ -pair* with structure-orbispace given by  $\mathbb{X}_v$ . A *morphism of panalocal  $\mathbb{T}$ -pairs*

$$\begin{aligned} \phi : (\mathcal{V}_1^{\star}, \{((\Pi_1)_{v_1} \curvearrowright (M_1)_{v_1})\}, \{((\mathbb{X}_1)_{v_1} \overset{\kappa}{\curvearrowright} (M_1)_{v_1})\}) \\ \rightarrow (\mathcal{V}_2^{\star}, \{((\Pi_2)_{v_2} \curvearrowright (M_2)_{v_2})\}, \{((\mathbb{X}_2)_{v_2} \overset{\kappa}{\curvearrowright} (M_2)_{v_2})\}) \end{aligned}$$

is defined to consist of a *morphism of panalocal Galois-theaters*  $\phi_{\mathcal{V}^{\star}} : \mathcal{V}_1^{\star} \rightarrow \mathcal{V}_2^{\star}$ , together with *compatible  $\mathbb{T}$ -isomorphisms* of (orbi-) *MLF-Galois  $\mathbb{T}$ -pairs*  $\phi_{v_1} : ((\Pi_1)_{v_1} \curvearrowright (M_1)_{v_1}) \rightarrow ((\Pi_2)_{v_2} \curvearrowright (M_2)_{v_2})$  (where  $V_1^{\text{non}} \ni v_1 \mapsto v_2 \in V_2^{\text{non}}$ ) and (orbi-) *Aut-holomorphic  $\mathbb{T}$ -pairs*  $\phi_{v_1} : ((\mathbb{X}_1)_{v_1} \overset{\kappa}{\curvearrowright} (M_1)_{v_1}) \rightarrow ((\mathbb{X}_2)_{v_2} \overset{\kappa}{\curvearrowright} (M_2)_{v_2})$  (where  $V_1^{\text{arc}} \ni v_1 \mapsto v_2 \in V_2^{\text{arc}}$ ). Write  $\mathfrak{H}_{\mathbb{T}}^\circ$  (respectively,  $\mathfrak{H}_{\mathbb{T}}^{\star}$ ) for the category of *global* (respectively, *panalocal*)  $\mathbb{T}$ -pairs and morphisms of global (respectively, panalocal)  $\mathbb{T}$ -pairs. Thus, it follows immediately from the definitions that we obtain a natural “*panalocalization functor*”

$$\mathfrak{H}_{\mathbb{T}}^\circ \rightarrow \mathfrak{H}_{\mathbb{T}}^{\star}$$

— lying over the functor  $\mathfrak{H}^\circ \rightarrow \mathfrak{H}^{\star}$  of (iv) — which is *essentially surjective*. Moreover, we have *compatible natural functors*  $\mathfrak{H}^\circ \rightarrow \mathbb{E}\mathbb{A}^\circ$ ,  $\mathfrak{H}_{\mathbb{T}}^\circ \rightarrow$

$\mathbb{EA}^\circledast$ , as well as *natural functors*

$$\mathfrak{Th}_{\mathbb{TF}}^\circledast \rightarrow \mathfrak{Th}_{\mathbb{TM}}^\circledast; \quad \mathfrak{Th}_{\mathbb{TM}}^\circledast \rightarrow \mathfrak{Th}_{\mathbb{TLG}}^\circledast; \quad \mathfrak{Th}_{\mathbb{TF}}^{\times} \rightarrow \mathfrak{Th}_{\mathbb{TM}}^{\times}; \quad \mathfrak{Th}_{\mathbb{TM}}^{\times} \rightarrow \mathfrak{Th}_{\mathbb{TLG}}^{\times}$$

(cf. Definition 3.1, (iii); Definition 4.1, (iii)).

REMARK 5.1.1. Note that the *reference isomorphism*  $\psi_{\bar{v}}$  of Definition 5.1, (iii), is *uniquely determined* by the conditions stated. Indeed, for *nonarchimedean* elements, this follows by considering the stabilizers in  $\Pi$  of elements of  $\bar{V}^{\text{non}}$ , together with the well-known fact that a nonarchimedean prime of  $\bar{F}$  (cf. the notation of Definition 5.1, (ii)) is uniquely determined by any open subgroup of its decomposition group in  $G_F$  (cf., e.g., [NSW], Corollary 12.1.3); for *archimedean* elements, this follows by considering the *topology* induced on  $\bar{k}_{\text{NF}}(\Pi)$  by  $\bar{A}_{\mathbb{X}_{\bar{v}}}$  via “ $\kappa_{\bar{v}}$ ” for  $\bar{v} \in \bar{V}^{\text{arc}}$ . Moreover, for  $\bar{v} \in \bar{V}^{\text{arc}}$ , the isomorphism  $\psi_{\bar{v}}$  of Definition 5.1, (iii), is *uniquely determined* by the condition of compatibility with  $\delta_{\text{ell}, \bar{v}_{\text{ell}}}$ ,  $\delta_{\bar{v}}$ . Indeed, by Corollary 2.3, (i) (cf. also [Mzk14], Lemma 1.3, (iii)), this follows from the well-known fact that any automorphism of a hyperbolic orbicurve that induces the identity outer automorphism of the profinite fundamental group of the orbicurve is itself the identity automorphism. Similar *uniqueness* statements (with similar proofs) hold for the morphisms  $\phi_{\bar{v}}$ ,  $\phi_{\bar{v}}$  of Definition 5.1, (iii).

COROLLARY 5.2 (First Properties of Galois-theaters and Pairs). *Let  $\mathbb{T} \in \{\mathbb{TF}, \mathbb{TM}\}$ . We shall apply a subscript “ $\mathbb{TM}$ ” to (global or local) arithmetic data of “ $\mathbb{T}$ -pairs” to denote the result of applying the natural functor whose codomain is the corresponding category of “ $\mathbb{TM}$ -pairs” (i.e., the identity functor if  $\mathbb{T} = \mathbb{TM}$  — cf. Proposition 3.2); we shall also use the subscript “ $\mathbb{TLG}$ ” in a similar way.*

(i) Write  $\mathfrak{An}^\circledast[\mathfrak{Th}^\circledast]$  for the category whose objects are data of the form

$$\mathcal{V}^\circledast(\Pi) \stackrel{\text{def}}{=} (\Pi \curvearrowright \mathbb{V}^\circledast(\Pi), \{\Pi_{\bar{v}}\}_{\bar{v} \in \mathbb{V}(\Pi)^{\text{non}}}, \{(\mathbb{X}(\Pi, \bar{v}), \delta_{\text{ell}, \bar{v}}, \kappa_{\text{ell}, \bar{v}})\}_{\bar{v} \in \mathbb{V}(\Pi)^{\text{arc}}})$$

(cf. the notation of Definition 5.1, (i)) for  $\Pi \in \text{Ob}(\mathbb{EA}^\circledast)$  and whose morphisms are the morphisms induced by morphisms of  $\mathbb{EA}^\circledast$ . Then we have natural functors

$$\mathbb{EA}^\circledast \rightarrow \mathfrak{An}^\circledast[\mathfrak{Th}^\circledast] \rightarrow \mathfrak{Th}^\circledast \rightarrow \mathbb{EA}^\circledast$$

— where the first arrow is the functor obtained by assigning  $\text{Ob}(\mathbb{E}\mathbb{A}^\circ) \ni \Pi \mapsto \mathcal{V}^\circ(\Pi)$ ; the second arrow is the functor obtained by forgetting the way in which the global Galois-theater data  $\mathcal{V}^\circ(\Pi)$  arose from  $\Pi$ ; the third arrow is the natural functor of Definition 5.1, (vi); the composite  $\mathbb{E}\mathbb{A}^\circ \rightarrow \mathbb{E}\mathbb{A}^\circ$  of these arrows is naturally isomorphic to the identity functor — all of which are equivalences of categories.

(ii) Let

$$(\mathcal{V}^\circ, M^\circ, \{\rho_{\bar{v}}\}_{\bar{v} \in \bar{V}}, \{(\Pi_{\bar{v}} \curvearrowright M_{\bar{v}})\}_{\bar{v} \in \bar{V}^{\text{non}}}, \{(\mathbb{X}_{\bar{v}} \overset{\kappa}{\curvearrowright} M_{\bar{v}})\}_{\bar{v} \in \bar{V}^{\text{arc}}})$$

be a global  $\mathbb{T}$ -pair (as in Definition 5.1, (v)). Then there is a unique (hence, in particular, there exists a functorial — relative to  $\mathfrak{Th}_{\mathbb{T}}^\circ$  — algorithm for constructing the) isomorphism

$$\mu_{\mathbb{Z}}(M_{\mathbb{T}\mathbb{M}}^\circ) \xrightarrow{\sim} \mu_{\mathbb{Z}}(\Pi)$$

(cf. Theorem 1.9, (b); Remark 1.10.1, (ii)) of  $\Pi$ -modules that is compatible — relative to the restriction morphisms  $\{\rho_{\bar{v}}\}_{\bar{v} \in \bar{V}^{\text{non}}}$  — with the isomorphisms  $\mu_{\mathbb{Z}}((M_{\bar{v}})_{\mathbb{T}\mathbb{M}}) \xrightarrow{\sim} \mu_{\mathbb{Z}}(\Pi_{\bar{v}})$ , for  $\bar{v} \in \bar{V}^{\text{non}}$ , obtained by composing the isomorphisms of Corollary 1.10, (c); Remark 3.2.1.

(iii) In the notation of (ii), there exists a functorial (i.e., relative to  $\mathfrak{Th}_{\mathbb{T}}^\circ$ ) algorithm for constructing the Kummer map

$$M_{\mathbb{T}\mathbb{M}}^\circ \xrightarrow{\sim} (M_{\mathbb{T}\mathbb{M}}^\circ)^{\text{gp}} \xrightarrow{\sim} M_{\mathbb{T}\mathbb{L}\mathbb{G}}^\circ \hookrightarrow \varinjlim_J H^1(J, \mu_{\mathbb{Z}}(M_{\mathbb{T}\mathbb{M}}^\circ)) \xrightarrow{\sim} \varinjlim_J H^1(J, \mu_{\mathbb{Z}}(\Pi))$$

— where “ $J$ ” ranges over the open subgroups of  $\Pi$ . In particular, the reference isomorphisms  $\psi^\circ, \{\psi_{\bar{v}}\}$  of Definition 5.1, (v), are uniquely determined by the conditions stated in Definition 5.1, (v); in a similar vein, the isomorphisms  $\phi^\circ, \{\phi_{\bar{v}}\}$  that appear in the definition of a “morphism  $\phi$  of global  $\mathbb{T}$ -pairs” in Definition 5.1, (v), are uniquely determined by  $\phi_{\mathcal{V}^\circ}$ .

(iv) Write  $\mathfrak{An}^\circ[\mathfrak{Th}_{\mathbb{T}}^\circ]$  for the category whose objects are data of the form

$$\begin{aligned} \mathcal{M}_{\mathbb{T}}^\circ(\Pi) \stackrel{\text{def}}{=} & (\mathcal{V}^\circ(\Pi), M_{\mathbb{T}^\circ}(\Pi), \{\rho_{\bar{v}}(\Pi)\}_{\bar{v} \in \mathbb{V}(\Pi)}, \\ & \{(\Pi_{\bar{v}} \curvearrowright M_{\mathbb{T}}(\Pi, \bar{v}))\}_{\bar{v} \in \mathbb{V}(\Pi)^{\text{non}}}, \\ & \{(\mathbb{X}(\Pi, \bar{v}) \overset{\kappa}{\curvearrowright} M_{\mathbb{T}}(\Pi, \bar{v}))\}_{\bar{v} \in \mathbb{V}(\Pi)^{\text{arc}}}) \end{aligned}$$

(cf. the notation of Definition 5.1, (v)) for  $\Pi \in \text{Ob}(\mathbb{EA}^\circ)$  and whose morphisms are the morphisms induced by morphisms of  $\mathbb{EA}^\circ$ . Then we have natural functors

$$\mathbb{EA}^\circ \rightarrow \mathfrak{An}^\circ[\mathfrak{Th}_\mathbb{T}^\circ] \rightarrow \mathfrak{Th}_\mathbb{T}^\circ \rightarrow \mathbb{EA}^\circ$$

— where the first arrow is the functor obtained by assigning  $\text{Ob}(\mathbb{EA}_\mathbb{T}^\circ) \ni \Pi \mapsto \mathcal{M}_\mathbb{T}^\circ(\Pi)$ ; the second arrow is the functor obtained by forgetting the way in which the global  $\mathbb{T}$ -pair data  $\mathcal{M}_\mathbb{T}^\circ(\Pi)$  arose from  $\Pi$ ; the third arrow is the natural functor of Definition 5.1, (vi); the composite  $\mathbb{EA}^\circ \rightarrow \mathbb{EA}^\circ$  of these arrows is naturally isomorphic to the identity functor — all of which are equivalences of categories that are (1-)compatible (in the evident sense) with the functors of (i).

(v) Write  $\mathfrak{An}^\circ[\mathfrak{Th}^\times]$  for the category whose objects are data of the form

$$\mathcal{V}^\times(\Pi) \stackrel{\text{def}}{=} (\Pi, \{\mathcal{V}^\circ(\Pi)\}^\times)$$

— where  $\mathcal{V}^\circ(\Pi)$  is as in (i); we use the notation “ $\{-\}^\times$ ” to denote the data obtained by applying the panalocalization functor  $\mathfrak{Th}^\circ \rightarrow \mathfrak{Th}^\times$  of Definition 5.1, (iv) — for  $\Pi \in \text{Ob}(\mathbb{EA}^\circ)$  and whose morphisms are the morphisms induced by morphisms of  $\mathbb{EA}^\circ$ . Then we have natural functors

$$\mathbb{EA}^\circ \rightarrow \mathfrak{An}^\circ[\mathfrak{Th}^\times] \rightarrow \mathfrak{Th}^\times$$

— where the first arrow is the functor obtained by assigning  $\text{Ob}(\mathbb{EA}^\circ) \ni \Pi \mapsto \mathcal{V}^\times(\Pi)$ ; the second arrow is the functor obtained by forgetting the way in which the panalocal Galois-theater data  $\{\mathcal{V}^\circ(\Pi)\}^\times$  arose from  $\Pi$ . Here, the first arrow  $\mathbb{EA}^\circ \rightarrow \mathfrak{An}^\circ[\mathfrak{Th}^\times]$  is an equivalence of categories.

(vi) Write  $\mathfrak{An}^\circ[\mathfrak{Th}_\mathbb{T}^\times]$  for the category whose objects are data of the form

$$\mathcal{M}_\mathbb{T}^\times(\Pi) \stackrel{\text{def}}{=} (\Pi, \{\mathcal{M}_\mathbb{T}^\circ(\Pi)\}^\times)$$

— where  $\mathcal{M}_\mathbb{T}^\circ(\Pi)$  is as in (iv); we use the notation “ $\{-\}^\times$ ” to denote the data obtained by applying the panalocalization functor  $\mathfrak{Th}^\circ \rightarrow \mathfrak{Th}^\times$  of Definition 5.1, (vi) — for  $\Pi \in \text{Ob}(\mathbb{EA}^\circ)$  and whose morphisms are the morphisms induced by morphisms of  $\mathbb{EA}^\circ$ . Then we have natural functors

$$\mathbb{EA}^\circ \rightarrow \mathfrak{An}^\circ[\mathfrak{Th}_\mathbb{T}^\times] \rightarrow \mathfrak{Th}_\mathbb{T}^\times$$



— where the first arrow is the functor obtained by assigning  $\text{Ob}(\mathbb{E}\mathbb{A}^\circ) \ni \Pi \mapsto \mathcal{M}_{\mathbb{T}}^{\times}(\Pi)$ ; the second arrow is the functor obtained by forgetting the way in which the panalocal  $\mathbb{T}$ -pair data  $\{\mathcal{M}_{\mathbb{T}}^{\circ}(\Pi)\}^{\times}$  arose from  $\Pi$ . Here, the first arrow  $\mathbb{E}\mathbb{A}^\circ \rightarrow \mathfrak{An}^\circ[\mathfrak{Th}_{\mathbb{T}}^{\times}]$  is an equivalence of categories.

(vii) By replacing, in the definition of the objects of  $\mathfrak{Th}_{\mathbb{T}}^{\times}$  (cf. Definition 5.1, (iv)), the data in  $\text{Orb}(\mathbb{T}\mathbb{G})$  (respectively,  $\text{Orb}(\mathbb{E}\mathbb{A})$ ) labeled by  $a(n)$  nonarchimedean (respectively, archimedean) valuation by (the result of applying  $(-)\mathbb{T}$  to) the data that constitutes the corresponding object of  $\text{Orb}(\mathfrak{Anab})$  (cf. Definition 3.1, (vi)) (respectively,  $\text{Orb}(\mathfrak{LinSol})$ ) (cf. Definition 4.1, (v)), we obtain a category

$$\mathfrak{An}^{\times}[\mathfrak{Th}_{\mathbb{T}}^{\times}]$$

— i.e., whose morphisms are the morphisms induced by morphisms of  $\mathfrak{Th}^{\times}$   
 — together with natural functors

$$\mathfrak{Th}^{\times} \rightarrow \mathfrak{An}^{\times}[\mathfrak{Th}_{\mathbb{T}}^{\times}] \rightarrow \mathfrak{Th}_{\mathbb{T}}^{\times} \rightarrow \mathfrak{Th}^{\times}$$

— where the first arrow is the functor arising from the definition of  $\mathfrak{An}^{\times}[\mathfrak{Th}_{\mathbb{T}}^{\times}]$ ; the second arrow is the “forgetful functor” (cf. the “forgetful functors” of assertion (ii) of Corollaries 3.6, 4.5); the third arrow is the natural functor (cf. Definition 5.1, (vi)); the composite  $\mathfrak{Th}^{\times} \rightarrow \mathfrak{Th}_{\mathbb{T}}^{\times}$  of these arrows is naturally isomorphic to the identity functor — all of which are equivalences of categories.

PROOF. In light of Remark 5.1.1, assertion (i) is immediate from the definitions and the results of §1, §2 (cf., especially, Theorem 1.9; Corollaries 1.10, 2.8) quoted in these definitions. Assertion (ii) follows, for instance, by comparing the given global  $\mathbb{T}$ -pair with the global  $\mathbb{T}$ -pair data  $\mathcal{M}_{\mathbb{T}}^{\circ}(\Pi)$  of assertion (iv) via the *reference isomorphisms* that appear in Definition 5.1, (v). In light of assertion (ii), assertion (iii) is immediate from the definitions (cf. also Proposition 3.2, (ii), (iv), at the *nonarchimedean*  $\bar{v}$ ; “ $\kappa_{\bar{v}}$ ”, the Kummer structure of “ $(\mathbb{X}_{\bar{v}} \xrightarrow{\kappa} M_{\bar{v}})$ ” at *archimedean*  $\bar{v}$ ). In light of assertion (iii), assertion (iv) is immediate from the definitions and the results of §1, §2 (cf., especially, Theorem 1.9; Corollaries 1.10, 2.8) quoted in these definitions. In a similar vein, assertions (v), (vi), and (vii) are immediate from the definitions and the results quoted in these definitions

(cf. also Proposition 3.2, (ii), (iv), at the *nonarchimedean*  $\bar{v}$ ; “ $\kappa_{\bar{v}}$ ”, the Kummer structure of “ $(\mathbb{X}_{\bar{v}} \overset{\kappa}{\curvearrowright} M_{\bar{v}})$ ” at *archimedean*  $\bar{v}$ ).  $\square$

REMARK 5.2.1. Note that *neither* of the *composite functors*  $\mathbb{E}\mathbb{A}^{\circlearrowleft} \rightarrow \mathfrak{Th}^{\times}, \mathbb{E}\mathbb{A}^{\circlearrowleft} \rightarrow \mathfrak{Th}_{\mathbb{T}}^{\times}$  of Corollary 5.2, (v), (vi) is an equivalence of categories! Put another way, there is *no natural, functorial way* to “glue together” the various local data of a panalocal Galois-theater/ $\mathbb{T}$ -pair so as so obtain a “global profinite group” that determines an object of  $\mathbb{E}\mathbb{A}^{\circlearrowleft}$ .

REMARK 5.2.2. By applying the *equivalence*  $\mathbb{E}\mathbb{A}^{\circlearrowleft} \xrightarrow{\sim} \mathfrak{Th}^{\circlearrowleft}$  of Corollary 5.2, (i), one may obtain a *factorization*

$$\mathbb{E}\mathbb{A}^{\circlearrowleft} \rightarrow \mathfrak{Th}^{\circlearrowleft} \rightarrow \mathfrak{An}^{\circlearrowleft}[\mathfrak{Th}_{\mathbb{T}}^{\circlearrowleft}]$$

of the functor  $\mathbb{E}\mathbb{A}^{\circlearrowleft} \rightarrow \mathfrak{An}^{\circlearrowleft}[\mathfrak{Th}_{\mathbb{T}}^{\circlearrowleft}]$  of Corollary 5.2, (iv). Thus, we obtain *equivalences of categories*  $\mathfrak{Th}^{\circlearrowleft} \xrightarrow{\sim} \mathfrak{An}^{\circlearrowleft}[\mathfrak{Th}_{\mathbb{T}}^{\circlearrowleft}] \xrightarrow{\sim} \mathfrak{Th}^{\circlearrowleft}$ ; the functor  $\mathfrak{Th}^{\circlearrowleft} \rightarrow \mathfrak{An}^{\circlearrowleft}[\mathfrak{Th}_{\mathbb{T}}^{\circlearrowleft}]$  may be thought of as a “*global analogue*” of the *panalocal functor*  $\mathfrak{Th}^{\times} \rightarrow \mathfrak{An}^{\times}[\mathfrak{Th}_{\mathbb{T}}^{\times}]$  of Corollary 5.2, (vii).

REMARK 5.2.3. A similar result to Corollary 5.2, (ii) (hence also similar results to Corollary 5.2, (iii), (iv)), may be obtained when  $\mathbb{T} = \text{TLG}$ , by using the *archimedean* primes, which are “*immune*” to the  $\{\pm 1\}$ -*indeterminacy* of Proposition 3.3, (i). Indeed, in the notation of Definition 5.1, (iii), (v), if  $\bar{v} \in \bar{V}^{\text{arc}}$ , then by combining “ $\kappa_{\text{ell}, \bar{v}_{\text{ell}}}$ ” with the isomorphism “ $\psi_{\bar{v}}$ ” arising from the *reference isomorphism* of the global Galois-theater under consideration yields an inclusion of fields  $\bar{k}_{\text{NF}}(\Pi) \hookrightarrow \bar{\mathcal{A}}_{\mathbb{X}(\Pi, \bar{v}_{\text{ell}})} \xrightarrow{\sim} \bar{\mathcal{A}}_{\mathbb{X}_{\bar{v}}}$ . On the other hand, by applying Corollary 1.10, (c); Remark 1.10.3, (ii), at any of the *nonarchimedean* elements of  $\bar{V}$ , it follows that  $\mu_{\bar{\mathbb{Z}}}(\Pi)$  may be related to the roots of unity of  $\bar{k}_{\text{NF}}(\Pi)$ , while the *restriction morphism* at  $\bar{v}$  of the global  $\mathbb{T}$ -pair under consideration, together with the *Kummer structure* at  $\bar{v}$ , allow one to relate  $\mu_{\bar{\mathbb{Z}}}(M^{\circlearrowleft})$  to the roots of unity of  $\bar{\mathcal{A}}_{\mathbb{X}_{\bar{v}}}$ . Thus, we obtain a *functorial algorithm* (albeit somewhat more complicated than the algorithm discussed in Corollary 5.2, (ii)) for constructing the *natural isomorphism*  $\mu_{\bar{\mathbb{Z}}}(M^{\circlearrowleft}) \xrightarrow{\sim} \mu_{\bar{\mathbb{Z}}}(\Pi)$ .

DEFINITION 5.3. Let  $\mathbb{T} \in \{\text{TF}, \text{TM}, \text{TLG}\}$ . We shall apply a subscript “TLG” (respectively, “TCG”) to arithmetic data of “ $\mathbb{T}$ -pairs” to denote the result of applying the natural functor whose codomain is the corresponding

category of “TLG- (respectively, TCG) pairs” (cf. Proposition 3.2; Corollary 5.2). In the following, the symbols

$$\boxtimes, \boxplus$$

are to be understood as shorthand for the terms “multiplicative” and “additive”, respectively. Let

$$\mathcal{M}^\circ \stackrel{\text{def}}{=} (\mathcal{V}^\circ, M^\circ, \{\rho_{\bar{v}}\}_{\bar{v} \in \bar{V}}, \{(\Pi_{\bar{v}} \curvearrowright M_{\bar{v}})\}_{\bar{v} \in \bar{V}^{\text{non}}}, \{(\mathbb{X}_{\bar{v}} \overset{\kappa}{\curvearrowright} M_{\bar{v}})\}_{\bar{v} \in \bar{V}^{\text{arc}}})$$

be a *global T-pair* (where  $\mathcal{V}^\circ$  is as in Definition 5.1, (iii)). Thus,  $\mathcal{M}^\circ$  is equipped with a *natural*  $\text{Aut}(\Pi)$ -action (cf. Corollary 5.2, (iv); Remark 5.2.3). In the following, we shall use a superscript profinite group to denote the sub-object of *invariants* with respect to that profinite group; if  $v \in V \stackrel{\text{def}}{=} \bar{V}/\text{Aut}(\Pi)$ , then we shall write  $M_v$  for the arithmetic data of the (orbi-)MLF-Galois/Aut-holomorphic T-pair indexed by  $v$  of the *panalocal* T-pair determined by  $\mathcal{M}^\circ$ , and  $\Pi_v$  for the (orbi-)decomposition group of  $v$ .

(i) Suppose that  $\mathbb{T} = \text{TLG}$ . Then a  $\boxtimes$ -line bundle  $\mathcal{L}^\boxtimes$  on  $\mathcal{M}^\circ$  is defined to be a collection of data

$$(\mathcal{L}^\boxtimes[\circ]; \{\tau[v] \in \mathcal{L}^\boxtimes[v]_{\mathbb{T}\mathbb{V}}\}_{v \in V})$$

— where  $\mathcal{L}^\boxtimes[\circ]$  is an  $(M^\circ)^\Pi$ -torsor equipped with an  $\text{Out}(\Pi)$ -action that is compatible with the natural  $\text{Out}(\Pi)$ -action on  $(M^\circ)^\Pi$  and, moreover, factors through the quotient  $\text{Out}(\Pi) \rightarrow \text{Im}(\text{Out}(\Pi) \rightarrow \text{Out}(\Pi/\Delta))$ ; for each  $v \in V$ ,

$$\tau[v] \in \mathcal{L}^\boxtimes[v]_{\mathbb{T}\mathbb{V}}$$

is a *trivialization* of the torsor  $\mathcal{L}^\boxtimes[v]_{\mathbb{T}\mathbb{V}}$  over  $(M_v^{\Pi_v})_{\mathbb{T}\mathbb{V}} \stackrel{\text{def}}{=} M_v^{\Pi_v}/(M_v^{\Pi_v})_{\text{TCG}}$  determined by the  $M_v^{\Pi_v}$ -torsor  $\mathcal{L}^\boxtimes[v]$  obtained from  $\mathcal{L}^\boxtimes[\circ]$  via  $\rho_{\bar{v}}$ , for  $\bar{v} \in \bar{V}$  lying over  $v$  — such that any element of  $\mathcal{L}^\boxtimes[\circ]$  determines (by restriction) the element of  $\mathcal{L}^\boxtimes[v]_{\mathbb{T}\mathbb{V}}$  given by  $\tau[v]$ , for *all but finitely many*  $v \in V$ . (Here, we note that the “(topological) value group”  $(M_v^{\Pi_v})_{\mathbb{T}\mathbb{V}}$  is equipped with a natural *ordering* (which may be used to define its topology) and is  $\cong \mathbb{Z}$  if  $v \in V^{\text{non}}$  and  $\cong \mathbb{R}$  if  $v \in V^{\text{arc}}$ ; moreover the natural ordering on  $(M_v^{\Pi_v})_{\mathbb{T}\mathbb{V}}$  determines a natural ordering on  $\mathcal{L}^\boxtimes[v]_{\mathbb{T}\mathbb{V}}$ .) A *morphism of  $\boxtimes$ -line bundles* on  $\mathcal{M}^\circ$

$$\zeta : \mathcal{L}_1^\boxtimes \rightarrow \mathcal{L}_2^\boxtimes$$

is defined to be an  $\text{Out}(\Pi)$ -equivariant isomorphism  $\zeta[\odot] : \mathcal{L}_1^{\boxtimes}[\odot] \xrightarrow{\sim} \mathcal{L}_2^{\boxtimes}[\odot]$  between the respective  $(M^\odot)^\Pi$ -torsors such that each  $v \in V$  induces an isomorphism  $\zeta[v]_{\mathbb{T}\mathbb{V}} : \mathcal{L}_1^{\boxtimes}[v]_{\mathbb{T}\mathbb{V}} \xrightarrow{\sim} \mathcal{L}_2^{\boxtimes}[v]_{\mathbb{T}\mathbb{V}}$  that maps  $\tau_1[v]$  to an element of  $\mathcal{L}_2^{\boxtimes}[v]_{\mathbb{T}\mathbb{V}}$  that is  $\leq \tau_2[v]$ . Write

$$\mathfrak{H}_{\mathbb{T}}^{\circ\boxtimes}[\mathcal{M}^\odot]$$

for the category of  $\boxtimes$ -line bundles on  $\mathcal{M}^\odot$  and morphisms of  $\boxtimes$ -line bundles on  $\mathcal{M}^\odot$ . If  $\phi : \mathcal{M}_1^\odot \rightarrow \mathcal{M}_2^\odot$  is a morphism of global  $\mathbb{T}$ -pairs, then there is a natural pull-back functor  $\phi^* : \mathfrak{H}_{\mathbb{T}}^{\circ\boxtimes}[\mathcal{M}_2^\odot] \rightarrow \mathfrak{H}_{\mathbb{T}}^{\circ\boxtimes}[\mathcal{M}_1^\odot]$ . In particular, the various categories  $\mathfrak{H}_{\mathbb{T}}^{\circ\boxtimes}[\mathcal{M}^\odot]$  together form a fibered category

$$\mathfrak{H}_{\mathbb{T}}^{\circ\boxtimes} \rightarrow \mathfrak{H}_{\mathbb{T}}^\circ$$

over  $\mathfrak{H}_{\mathbb{T}}^\circ$ , whose fibers are the categories  $\mathfrak{H}_{\mathbb{T}}^{\circ\boxtimes}[\mathcal{M}^\odot]$ . Finally, we observe that one may generalize these definitions to the case of arbitrary  $\mathbb{T} \in \{\text{TF}, \text{TM}, \text{TLG}\}$  by applying the subscript “TLG”, where necessary.

(ii) Suppose that  $\mathbb{T} = \text{TF}$ . Write  $\mathcal{O}_{M^\odot}$  for the ring of integers of the field  $M^\odot$ . Then an  $\boxplus$ -line bundle  $\mathcal{L}^\boxplus$  on  $\mathcal{M}^\odot$  is defined to be a collection of data

$$(\mathcal{L}^\boxplus[\odot]; \quad \{ | - |_{\mathcal{L}^\boxplus[v]} \}_{v \in V^{\text{arc}}})$$

— where  $\mathcal{L}^\boxplus[\odot]$  is a rank one projective  $\mathcal{O}_{M^\odot}^\Pi$ -module equipped with an  $\text{Out}(\Pi)$ -action that is compatible with the natural  $\text{Out}(\Pi)$ -action on  $(M^\odot)^\Pi$  and, moreover, factors through the quotient  $\text{Out}(\Pi) \twoheadrightarrow \text{Im}(\text{Out}(\Pi)) \rightarrow \text{Out}(\Pi/\Delta)$ ; for each  $v \in V^{\text{arc}}$ ,

$$| - |_{\mathcal{L}^\boxplus[v]}$$

is a Hermitian metric on the  $M_v$ -vector space  $\mathcal{L}^\boxplus[v]$  obtained from  $\mathcal{L}^\boxplus[\odot] \otimes (M^\odot)^\Pi$  via  $\rho_{\bar{v}}$ , for  $\bar{v} \in \bar{V}$  lying over  $v$ . (Here, we recall that  $M_v$  is an (orbi-)complex archimedean field.) In this situation, we shall also write  $\mathcal{L}^\boxplus[v]$  for the  $M_v^{\Pi}$ -vector space obtained from  $\mathcal{L}^\boxplus[\odot] \otimes (M^\odot)^\Pi$  via  $\rho_{\bar{v}}$ , for  $\bar{v} \in \bar{V}$  lying over  $v \in V^{\text{non}}$ . In particular, the  $\mathcal{O}_{M^\odot}^\Pi$ -module  $\mathcal{O}_{M^\odot}^\Pi$ , equipped with its usual Hermitian metrics at elements of  $V^{\text{arc}}$ , determines an  $\boxplus$ -line bundle which we shall refer to as the trivial  $\boxplus$ -line bundle. A morphism of  $\boxplus$ -line bundles on  $\mathcal{M}^\odot$

$$\zeta : \mathcal{L}_1^\boxplus \rightarrow \mathcal{L}_2^\boxplus$$

is defined to be a *nonzero*  $\text{Out}(\Pi)$ -equivariant morphism of  $\mathcal{O}_{M^\circ}^\Pi$ -modules  $\zeta[\circ] : \mathcal{L}_1^\boxplus[\circ] \rightarrow \mathcal{L}_2^\boxplus[\circ]$  such that for each  $v \in V^{\text{arc}}$ , the induced isomorphism  $\zeta[v] : \mathcal{L}_1^\boxplus[v] \xrightarrow{\sim} \mathcal{L}_2^\boxplus[v]$  maps *integral* elements (i.e., elements of norm  $\leq 1$ ) with respect to  $|\cdot|_{\mathcal{L}_1^\boxplus[v]}$  to *integral* elements with respect to  $|\cdot|_{\mathcal{L}_2^\boxplus[v]}$ . Write

$$\mathfrak{H}_{\mathbb{T}}^{\circ\boxplus}[\mathcal{M}^\circ]$$

for the *category* of  $\boxplus$ -line bundles on  $\mathcal{M}^\circ$  and morphisms of  $\boxplus$ -line bundles on  $\mathcal{M}^\circ$ . If  $\phi : \mathcal{M}_1^\circ \rightarrow \mathcal{M}_2^\circ$  is a *morphism of global  $\mathbb{T}$ -pairs*, then there is a *natural pull-back functor*  $\phi^* : \mathfrak{H}_{\mathbb{T}}^{\circ\boxplus}[\mathcal{M}_2^\circ] \rightarrow \mathfrak{H}_{\mathbb{T}}^{\circ\boxplus}[\mathcal{M}_1^\circ]$ . In particular, the various categories  $\mathfrak{H}_{\mathbb{T}}^{\circ\boxplus}[\mathcal{M}^\circ]$  “glue together” to form a *fibered category*

$$\mathfrak{H}_{\mathbb{T}}^{\circ\boxplus} \rightarrow \mathfrak{H}_{\mathbb{T}}^\circ$$

over  $\mathfrak{H}_{\mathbb{T}}^\circ$ , whose fibers are the categories  $\mathfrak{H}_{\mathbb{T}}^{\circ\boxplus}[\mathcal{M}^\circ]$ . Finally, the assignment (in the notation of the above discussion)

$$\mathcal{L}^\boxplus[\circ] \mapsto \left( \text{the } (M_{\mathbb{T}\mathbb{L}\mathbb{G}}^\circ)^\Pi\text{-torsor of nonzero sections of } \mathcal{L}^\boxplus[\circ] \otimes (M^\circ)^\Pi \right)$$

determines (in an evident fashion) an *equivalence of categories*

$$\mathfrak{H}_{\mathbb{T}}^{\circ\boxplus} \xrightarrow{\sim} \mathfrak{H}_{\mathbb{T}}^{\circ\boxtimes}$$

over  $\mathfrak{H}_{\mathbb{T}}^\circ$ , i.e., an “*equivalence of  $\boxtimes$ - and  $\boxplus$ -line bundles*”.

(iii) Let  $\square \in \{\boxtimes, \boxplus\}$ ; if  $\square = \boxplus$ , then assume that  $\mathbb{T} = \mathbb{T}\mathbb{F}$ . Then observe that the *automorphism group* of any object of  $\mathfrak{H}_{\mathbb{T}}^{\circ\square}[\mathcal{M}^\circ]$  is naturally isomorphic to the finite abelian group  $\mu_{\mathbb{Q}/\mathbb{Z}}(M_{\mathbb{T}\mathbb{L}\mathbb{G}}^\circ)^{\text{Aut}(\Pi)}$ . To avoid various problems arising from these automorphisms, it is often useful to work with “*coarsified versions*” of the categories introduced in (i), (ii), as follows. Write

$$\mathfrak{H}_{\mathbb{T}}^{\circ\square}[\mathcal{M}^\circ]$$

for the (*small, id-rigid!*) category whose objects are *isomorphism classes* of objects of  $\mathfrak{H}_{\mathbb{T}}^{\circ\square}[\mathcal{M}^\circ]$  and whose morphisms are  $\mu_{\mathbb{Q}/\mathbb{Z}}(M_{\mathbb{T}\mathbb{L}\mathbb{G}}^\circ)^{\text{Aut}(\Pi)}$ -orbits of morphisms of  $\mathfrak{H}_{\mathbb{T}}^{\circ\square}[\mathcal{M}^\circ]$ . Thus, by allowing “ $\mathcal{M}^\circ$ ” to vary, we obtain a *fibered category*

$$\mathfrak{H}_{\mathbb{T}}^{\circ\square} \rightarrow \mathfrak{H}_{\mathbb{T}}^\circ$$

over  $\mathfrak{H}_{\mathbb{T}}^{\odot}$ , whose fibers are the categories  $\mathfrak{H}_{\mathbb{T}}^{\odot|\square|}[\mathcal{M}^{\odot}]$ . Finally, the equivalence of categories of (ii) determines an *equivalence of categories*  $\mathfrak{H}_{\mathbb{T}}^{\odot|\boxplus|} \xrightarrow{\sim} \mathfrak{H}_{\mathbb{T}}^{\odot|\boxtimes|}$ .

REMARK 5.3.1. In the notation of Definition 5.3, (iii), one may define — in the *style* of Corollary 5.2, (iv) — a *category*  $\mathfrak{An}^{\odot}[\mathfrak{H}_{\mathbb{T}}^{\odot}, |\square|]$  whose objects are data of the form

$$\mathcal{M}_{\mathbb{T}}^{\odot|\square|}(\Pi) \stackrel{\text{def}}{=} (\mathcal{M}_{\mathbb{T}}^{\odot}(\Pi), \mathfrak{H}_{\mathbb{T}}^{\odot|\square|}[\mathcal{M}_{\mathbb{T}}^{\odot}(\Pi)])$$

for  $\Pi \in \text{Ob}(\mathbb{EA}^{\odot})$  and whose morphisms are the morphisms induced by morphisms of  $\mathbb{EA}^{\odot}$ . Here, we think of the datum “ $\mathfrak{H}_{\mathbb{T}}^{\odot|\square|}[\mathcal{M}_{\mathbb{T}}^{\odot}(\Pi)]$ ” as an object of the category whose *objects* are small categories with trivial automorphism groups and whose *morphisms* are *contravariant functors*. Then, just as in Corollary 5.2, (iv), one obtains a sequence of *natural functors*

$$\mathbb{EA}^{\odot} \rightarrow \mathfrak{An}^{\odot}[\mathfrak{H}_{\mathbb{T}}^{\odot}, |\square|] \rightarrow \mathfrak{An}^{\odot}[\mathfrak{H}_{\mathbb{T}}^{\odot}] \rightarrow \mathfrak{H}_{\mathbb{T}}^{\odot} \rightarrow \mathbb{EA}^{\odot}$$

— where the first arrow is the functor obtained by assigning  $\text{Ob}(\mathbb{EA}_{\mathbb{T}}^{\odot}) \ni \Pi \mapsto \mathcal{M}_{\mathbb{T}}^{\odot|\square|}(\Pi)$  — all of which are *equivalences of categories*.

DEFINITION 5.4. Let  $\mathbb{T} \in \{\text{TF}, \text{TM}\}$ ,  $\bullet \in \{\odot, \boxtimes\}$ .

(i) If  $Z$  is an *elliptically admissible* hyperbolic orbicurve over an algebraic closure of  $\mathbb{Q}$ , then we shall refer to a hyperbolic orbicurve  $X$  as in Definition 5.1, (ii), as *geometrically isomorphic to  $Z$*  if (in the notation of *loc. cit.*) there exists an isomorphism of schemes  $X_{\overline{\mathbb{F}}} \cong Z$ . Write

$$\mathbb{EA}^{\odot}[Z] \subseteq \mathbb{EA}^{\odot}$$

for the *full subcategory* determined by the profinite groups isomorphic to  $\Pi_X$  for some  $X$  as in Definition 5.1, (i), that is geometrically isomorphic to  $Z$ . This full subcategory determines, in an evident fashion, *full subcategories*

$$\mathfrak{H}^{\bullet}[Z] \subseteq \mathfrak{H}^{\bullet}; \quad \mathfrak{H}_{\mathbb{T}}^{\bullet}[Z] \subseteq \mathfrak{H}_{\mathbb{T}}^{\bullet}$$

— as well as full subcategories of the “ $\mathfrak{An}^{\odot}[-]$ ” *versions* of these categories discussed in Corollary 5.2 and the “ $\boxtimes$ -,  $\boxplus$ -line bundle versions” discussed in Remark 5.3.1 (cf. also the “*measure-theoretic versions*” discussed in Remark 5.9.1 below).

(ii) By applying the functors “ $\mathbf{log}_{\mathbb{T},\mathbb{T}}$ ” of Proposition 3.2, (v); Proposition 4.2, (ii), to the various local data of a *panalocal*  $\mathbb{T}$ -pair, we obtain a *panalocal log-Frobenius functor*

$$\mathbf{log}_{\mathbb{T},\mathbb{T}}^{\times} : \mathfrak{H}_{\mathbb{T}}^{\times} \rightarrow \mathfrak{H}_{\mathbb{T}}^{\times}$$

which is *naturally isomorphic to the identity functor*, hence, in particular, an *equivalence of categories*. Note that the construction underlying this functor leaves the *underlying panalocal Galois-theater* unchanged, i.e.,  $\mathbf{log}_{\mathbb{T},\mathbb{T}}^{\times}$  “lies over”  $\mathfrak{H}^{\times}$ . Now suppose that

$$\mathcal{M}^{\circ} \stackrel{\text{def}}{=} (\mathcal{V}^{\circ}, M^{\circ}, \{\rho_{\bar{v}}\}_{\bar{v} \in \bar{V}}, \{(\Pi_{\bar{v}} \curvearrowright M_{\bar{v}})\}_{\bar{v} \in \bar{V}^{\text{non}}}, \{(\mathbb{X}_{\bar{v}} \overset{\kappa}{\curvearrowright} M_{\bar{v}})\}_{\bar{v} \in \bar{V}^{\text{arc}}})$$

is a *global*  $\mathbb{T}$ -pair (where  $\mathcal{V}^{\circ}$  is as in Definition 5.1, (iii)). Note that the various *restriction morphisms*  $\rho_{\bar{v}}$  determine a  $\Pi$ -equivariant embedding

$$M^{\circ} \hookrightarrow \prod_{\bar{v} \in \bar{V}} M_{\bar{v}}^{\mathbb{T}^{\circ}}$$

of  $M^{\circ}$  into a certain product of local data. Thus, by applying the functors “ $\mathbf{log}_{\mathbb{T},\mathbb{T}}$ ” of Proposition 3.2, (v); Proposition 4.2, (ii), to the various *local data* of  $\mathcal{M}^{\circ}$  (i.e., more precisely: the data, *other than the*  $\{\rho_{\bar{v}}\}$ , that is *indexed by*  $\bar{v} \in \bar{V}$ ), we obtain a “local log-Frobenius functor  $\mathbf{log}_{\mathbb{T},\mathbb{T}}^{\bar{v}}$ ” on the portion of a global  $\mathbb{T}$ -pair constituted by this local data which is *naturally isomorphic to the identity functor*. Moreover, by *composing this natural isomorphism* to the identity functor with the above *embedding* of  $M^{\circ}$ , we obtain a *new*  $\Pi$ -equivariant embedding

$$M^{\circ} \hookrightarrow \prod_{\bar{v} \in \bar{V}} \mathbf{log}_{\mathbb{T},\mathbb{T}}^{\bar{v}}(M_{\bar{v}}^{\mathbb{T}^{\circ}})$$

of  $M^{\circ}$  into the product (as above) that arises from the *output* “ $\mathbf{log}_{\mathbb{T},\mathbb{T}}^{\bar{v}}(M_{\bar{v}}^{\mathbb{T}^{\circ}})$ ” of  $\mathbf{log}_{\mathbb{T},\mathbb{T}}^{\bar{v}}$ . In particular, by taking the *image of this new embedding* to be the global data  $\in \text{Ob}(\mathbb{T}^{\circ})$  (i.e., the “ $M_{\circ}$ ”) of a *new* global  $\mathbb{T}$ -pair whose local data is given by applying  $\mathbf{log}_{\mathbb{T},\mathbb{T}}^{\bar{v}}$  to the local data of  $\mathcal{M}^{\circ}$ , we obtain a *global log-Frobenius functor*

$$\mathbf{log}_{\mathbb{T},\mathbb{T}}^{\circ} : \mathfrak{H}_{\mathbb{T}}^{\circ} \rightarrow \mathfrak{H}_{\mathbb{T}}^{\circ}$$

which is *naturally isomorphic to the identity functor*, hence, in particular, an *equivalence of categories*. Moreover, the construction underlying this

functor leaves the *underlying global Galois-theater* unchanged, i.e.,  $\mathbf{log}_{\mathbb{T},\mathbb{T}}^{\circledast}$  “lies over”  $\mathfrak{Th}^{\circledast}$ . In the following discussion, we shall often denote (by abuse of notation) the *restriction* of  $\mathbf{log}_{\mathbb{T},\mathbb{T}}^{\bullet}$  to the categories “ $(-)[Z]$ ” by  $\mathbf{log}_{\mathbb{T},\mathbb{T}}^{\bullet}$ . Note that if one *restricts to the categories* “ $(-)[Z]$ ”, then the set “ $\overline{V}/\text{Aut}(\Pi)$ ” has a meaning which is *independent of the choice of a particular object* of one of these categories (cf. the discussion of Definition 5.1, (ii)). In the following, let us *fix* a  $v \in V \stackrel{\text{def}}{=} \overline{V}/\text{Aut}(\Pi)$ .

(iii) Consider, in the notation of Definition 3.1, (iv), the *commutative diagram* of natural maps

$$\begin{array}{ccccccc}
 & & & \mathcal{O}_{\overline{k}}^{\times} & \hookrightarrow & \overline{k}^{\times} & \hookrightarrow & \overline{k} & \dots \text{space-link} \\
 & & & \downarrow \text{shell} & & \downarrow & & & \\
 \text{post-log...} & k^{\sim} & \xrightarrow{\text{id}} & k^{\sim} & \hookrightarrow & (\overline{k}^{\times})^{\text{pf}} & & & 
 \end{array}$$

— where we recall that  $k^{\sim} \stackrel{\text{def}}{=} (\mathcal{O}_{\overline{k}}^{\times})^{\text{pf}}$  — a diagram which determines an *oriented graph*  $\overline{\Gamma}_{\text{non}}^{\text{log}}$  (i.e., whose vertices and oriented edges correspond, respectively, to the objects and arrows of the above diagram); write  $\overline{\Gamma}_{\text{non}}^{\times}$  (respectively,  $\overline{\Gamma}_{\text{non}}^{\times}$ ) for the oriented subgraph of  $\overline{\Gamma}_{\text{non}}^{\text{log}}$  obtained by removing the *upper right-hand* arrow “ $\hookrightarrow \overline{k}$ ” (respectively, the *lower left-hand* arrow “ $k^{\sim} \xrightarrow{\text{id}}$ ”) and  $\overline{\Gamma}_{\text{non}}^{\times}$  for the *intersection* of  $\overline{\Gamma}_{\text{non}}^{\times}$ ,  $\overline{\Gamma}_{\text{non}}^{\times}$ . Let us refer to the *lower left-hand* vertex of  $\overline{\Gamma}_{\text{non}}^{\text{log}}$  (i.e., the first “ $k^{\sim}$ ”) as the *post-log* vertex and to the other vertices of  $\overline{\Gamma}_{\text{non}}^{\text{log}}$  as *pre-log* vertices; also we shall refer to the *upper right-hand* vertex of  $\overline{\Gamma}_{\text{non}}^{\text{log}}$  (i.e., “ $\overline{k}$ ”) as the *space-link* vertex. Here, we wish to think of the *pre-log* copy of “ $k^{\sim}$ ” as an object (i.e., “ $(\mathcal{O}_{\overline{k}}^{\times})^{\text{pf}}$ ”) formed from  $\overline{k}^{\times}$  and of the *post-log* copy of “ $k^{\sim}$ ” as the “*new field*” — i.e., the new copy of the space-link vertex “ $\overline{k}$ ” — obtained by applying the *log-Frobenius functor*. Observe that the *entire diagram*  $\overline{\Gamma}_{\text{non}}^{\text{log}}$  may be considered as a diagram in the category  $\mathbb{TS}$ , whereas the diagram  $\overline{\Gamma}_{\text{non}}^{\times}$  may be considered either as a diagram in the category  $\mathbb{TS}$  or as a diagram in the category  $\mathbb{TS}\boxplus$  (i.e., relative to the *additive* topological group structure of the field  $k^{\sim}$ ). Write  $p_k$  for the *residue characteristic* of  $k$ ; set  $p_k^* \stackrel{\text{def}}{=} p_k$  if  $p_k$  is *odd* and  $p_k^* \stackrel{\text{def}}{=} p_k^2$  if  $p_k = 2$ . Then since (as is well-known) the  $p_k$ -*adic logarithm* determines a *bijection*  $1 + p_k^* \cdot \mathcal{O}_{\overline{k}} \xrightarrow{\sim} p_k^* \cdot \mathcal{O}_{\overline{k}}$ , it follows that

$$\mathcal{O}_{k^{\sim}}^{\Pi_k} \subseteq \mathcal{I} \stackrel{\text{def}}{=} (p_k^*)^{-1} \cdot \mathcal{I}^* \subseteq (k^{\sim})^{\Pi_k}$$



— where the superscript “ $\Pi_k$ ” denotes the submodule of Galois-invariants, and we write  $\mathcal{I}^*$  for the *image* of  $\mathcal{O}_k^\times = (\mathcal{O}_{\bar{k}}^\times)^{\Pi_k} \subseteq \mathcal{O}_{\bar{k}}^\times$  via the *left-hand vertical arrow* of the above diagram, i.e., in essence, the compact submodule constituted by the *pre-log-shell* discussed in Definition 3.1, (iv). We shall refer to  $\mathcal{I}$  as the *log-shell* of  $\vec{\Gamma}_{\text{non}}^\times$  and to the left-hand vertical arrow of the above diagram as the *shell-arrow*. In fact, if  $k$  is *absolutely unramified* and  $p_k$  is *odd*, then we have an *equality*  $\mathcal{O}_{k^\sim}^{\Pi_k} = \mathcal{I}$  (cf. Remark 5.4.2 below).

(iv) Next, let us suppose that  $v \in V^{\text{non}}$ ; recall the categories  $\mathcal{C}_{\mathbb{T}\mathbb{S}\boxplus}^{\text{MLF-sB}}$ ,  $\mathcal{C}_{\mathbb{T}\mathbb{S}}^{\text{MLF-sB}}$  of Definition 3.1, (iii). Thus, we have natural functors  $\mathcal{C}_{\mathbb{T}\mathbb{S}\boxplus}^{\text{MLF-sB}} \rightarrow \mathcal{C}_{\mathbb{T}\mathbb{S}}^{\text{MLF-sB}} \rightarrow \text{TG}$ . Let us write

$$\begin{aligned} \mathcal{N}_v^\boxplus &\stackrel{\text{def}}{=} \text{Orb}(\mathcal{C}_{\mathbb{T}\mathbb{S}\boxplus}^{\text{MLF-sB}}) \times_{\text{Orb}(\text{TG}),v} \mathfrak{H}^\bullet[Z]; \\ \mathcal{N}_v &\stackrel{\text{def}}{=} \text{Orb}(\mathcal{C}_{\mathbb{T}\mathbb{S}}^{\text{MLF-sB}}) \times_{\text{Orb}(\text{TG}),v} \mathfrak{H}^\bullet[Z] \end{aligned}$$

— where the “ $,v$ ” in the fibered product is to be understood as referring to the *natural functor*  $\mathfrak{H}^\bullet[Z] \rightarrow \text{Orb}(\text{TG})$  given by the assignment “ $\mathcal{V}^\bullet \mapsto \Pi_v$ ” (cf. Definition 5.1, (iv), (b)). Thus, we have *natural functors*  $\mathcal{N}_v^\boxplus \rightarrow \mathcal{N}_v \rightarrow \mathfrak{H}^\bullet[Z]$ . Next, in the notation of (iii), let us set  $\vec{\Gamma}_v^{\text{log}} \stackrel{\text{def}}{=} \vec{\Gamma}_{\text{non}}^{\text{log}}$ ,  $\vec{\Gamma}_v^\times \stackrel{\text{def}}{=} \vec{\Gamma}_{\text{non}}^\times$ ,  $\vec{\Gamma}_v^\times \stackrel{\text{def}}{=} \vec{\Gamma}_{\text{non}}^\times$ . Then for each vertex  $\nu$  of  $\vec{\Gamma}_v^\times$ , by assigning to “ $\bar{k}$ ” or “ $\mathcal{O}_{\bar{k}}^\triangleright$ ” (i.e., depending on the choice of  $\mathbb{T} \in \{\mathbb{T}\mathbb{F}, \mathbb{T}\mathbb{M}\}$ ) the object at the vertex  $\nu$  of the diagram of (iii), we obtain a *natural functor*  $\mathcal{C}_{\mathbb{T}}^{\text{MLF-sB}} \rightarrow \mathcal{C}_{\mathbb{T}\mathbb{S}\boxplus}^{\text{MLF-sB}}$ , hence by considering the portion of the panalocal or global  $\mathbb{T}$ -pair under consideration that is indexed by  $v$  or  $\bar{v} \in \bar{V}$  lying over  $v$ , a *natural functor*  $\lambda_{v,\nu}^\boxplus : \mathfrak{H}_{\mathbb{T}}^\bullet[Z] \rightarrow \mathcal{N}_v^\boxplus$ . In a similar vein, if  $\nu$  is either the *space-link* or the *post-log* vertex of  $\vec{\Gamma}_v^{\text{log}}$ , then by assigning to “ $\bar{k}$ ” or “ $\mathcal{O}_{\bar{k}}^\triangleright$ ” the *underlying additive topological group* of the field “ $\bar{k}$ ” (cf. the *functorial algorithms* of Corollary 1.10, as applied in Proposition 3.2, (iii)), we obtain a *natural functor*  $\mathcal{C}_{\mathbb{T}}^{\text{MLF-sB}} \rightarrow \mathcal{C}_{\mathbb{T}\mathbb{S}\boxplus}^{\text{MLF-sB}}$ , hence by considering the portion of the panalocal or global  $\mathbb{T}$ -pair under consideration that is indexed by  $v$  or  $\bar{v} \in \bar{V}$  lying over  $v$ , a *natural functor*  $\lambda_{v,\nu}^\boxplus : \mathfrak{H}_{\mathbb{T}}^\bullet[Z] \rightarrow \mathcal{N}_v^\boxplus$ . Thus, in summary, we obtain *natural functors*

$$\lambda_{v,\nu}^\boxplus : \mathfrak{H}_{\mathbb{T}}^\bullet[Z] \rightarrow \mathcal{N}_v^\boxplus; \quad \lambda_{v,\nu} : \mathfrak{H}_{\mathbb{T}}^\bullet[Z] \rightarrow \mathcal{N}_v$$

— where the latter functor is obtained by composing the former functor with the natural functor  $\mathcal{N}_v^\boxplus \rightarrow \mathcal{N}_v$  — that “lie over”  $\mathfrak{H}^\bullet[Z]$ , for each *vertex*  $\nu$  of  $\vec{\Gamma}_v^{\text{log}}$ .

(v) Consider, in the notation of Definition 4.1, (iv), the *commutative diagram* of natural maps

$$\text{post-log...} \quad k^\sim \xrightarrow{\text{id}} k^\sim \xrightarrow{\text{shell}} k^\times \hookrightarrow k \quad \dots\text{space-link}$$

— a diagram which determines an *oriented graph*  $\vec{\Gamma}_{\text{arc}}^{\text{log}}$  (i.e., whose vertices and oriented edges correspond, respectively, to the objects and arrows of the above diagram); write  $\vec{\Gamma}_{\text{arc}}^\times$  (respectively,  $\vec{\Gamma}_{\text{arc}}^\times$ ) for the oriented subgraph of  $\vec{\Gamma}_{\text{arc}}^{\text{log}}$  obtained by removing the arrow “ $\hookrightarrow k$ ” on the *right* (respectively, the arrow “ $k^\sim \xrightarrow{\text{id}}$ ” on the *left*) and  $\vec{\Gamma}_{\text{arc}}^\times$  for the *intersection* of  $\vec{\Gamma}_{\text{arc}}^\times$ ,  $\vec{\Gamma}_{\text{arc}}^\times$ . Let us refer to the vertex of  $\vec{\Gamma}_{\text{arc}}^{\text{log}}$  given by the first “ $k^\sim$ ” as the *post-log* vertex and to the other vertices of  $\vec{\Gamma}_{\text{arc}}^{\text{log}}$  as *pre-log* vertices; also we shall refer to the vertex of  $\vec{\Gamma}_{\text{arc}}^{\text{log}}$  given by “ $k$ ” as the *space-link* vertex. Here, we wish to think of the *pre-log* copy of “ $k^\sim$ ” as an object formed from  $k^\times$  and of the *post-log* copy of “ $k^\sim$ ” as the “*new field*” — i.e., the new copy of the space-link vertex “ $k$ ” — obtained by applying the *log-Frobenius functor*. Observe that the *entire diagram*  $\vec{\Gamma}_{\text{arc}}^{\text{log}}$  may be considered as a diagram in the category  $\mathbb{T}\mathbb{H}$ , whereas the diagram  $\vec{\Gamma}_{\text{arc}}^\times$  may be considered either as a diagram in the category  $\mathbb{T}\mathbb{H}$  or as a diagram in  $\mathbb{T}\mathbb{H}\boxplus$  (i.e., relative to the *additive* topological group structure of the field  $k^\sim$ ). Note that it follows from well-known properties of the (*complex*) *logarithm* that

$$\mathcal{O}_{k^\sim} = \frac{1}{\pi} \cdot \mathcal{I} \subseteq \mathcal{I} \stackrel{\text{def}}{=} \mathcal{O}_{k^\sim}^\times \cdot \mathcal{I}^* \subseteq k^\sim$$

— where we we write  $\mathcal{I}^*$  for the uniquely determined “*line segment*” (i.e., more precisely: closure of a connected pre-compact open subset of a one-parameter subgroup) of  $k^\sim$  which is *preserved by multiplication by  $\pm 1$*  and whose endpoints differ by a *generator* of  $\text{Ker}(k^\sim \rightarrow k^\times)$ . Thus,  $\mathcal{I}^*$  maps *bijectively*, except for the endpoints of the line segment, to the *pre-log-shell* discussed in Definition 4.1, (iv). We shall refer to  $\mathcal{I}$  as the *log-shell* of  $\vec{\Gamma}_{\text{arc}}^\times$  and to the arrow  $k^\sim \rightarrow k^\times$  as the *shell-arrow*. Also, we observe that  $\mathcal{I}$  may be constructed as the *closure* of the union of the images of  $\mathcal{I}^*$  via the *finite order automorphisms* of the Aut-holomorphic group  $k^\sim$ ; in particular, the *formation of  $\mathcal{I}$  from  $\mathcal{I}^*$*  depends only on the *structure of  $k^\sim$  as an object of  $\mathbb{T}\mathbb{H}\boxplus$* .

(vi) Next, let us suppose that  $v \in V^{\text{arc}}$ ; recall the categories  $\mathcal{C}_{\mathbb{T}\mathbb{H}\mathbb{H}}^{\text{hol}}$ ,  $\mathcal{C}_{\mathbb{T}\mathbb{H}}^{\text{hol}}$  of Definition 4.1, (iii). Thus, we have natural functors  $\mathcal{C}_{\mathbb{T}\mathbb{H}\mathbb{H}}^{\text{hol}} \rightarrow \mathcal{C}_{\mathbb{T}\mathbb{H}}^{\text{hol}} \rightarrow \mathbb{E}\mathbb{A}$ . Let us write

$$\mathcal{N}_v^{\boxplus} \stackrel{\text{def}}{=} \text{Orb}(\mathcal{C}_{\mathbb{T}\mathbb{H}\mathbb{H}}^{\text{hol}}) \times_{\text{Orb}(\mathbb{E}\mathbb{A}),v} \mathfrak{H}^\bullet[Z]; \quad \mathcal{N}_v \stackrel{\text{def}}{=} \text{Orb}(\mathcal{C}_{\mathbb{T}\mathbb{H}}^{\text{hol}}) \times_{\text{Orb}(\mathbb{E}\mathbb{A}),v} \mathfrak{H}^\bullet[Z]$$

— where the “ $v$ ” in the fibered product is to be understood as referring to the *natural functor*  $\mathfrak{H}^\bullet[Z] \rightarrow \text{Orb}(\mathbb{E}\mathbb{A})$  given by the assignment “ $\mathcal{V}^\bullet \mapsto \mathbb{X}_v$ ” (cf. Definition 5.1, (iv), (c)). Thus, we have *natural functors*  $\mathcal{N}_v^{\boxplus} \rightarrow \mathcal{N}_v \rightarrow \mathfrak{H}^\bullet[Z]$ . Next, in the notation of (v), let us set  $\vec{\Gamma}_v^{\text{log}} \stackrel{\text{def}}{=} \vec{\Gamma}_{\text{arc}}^{\text{log}}$ ,  $\vec{\Gamma}_v^\times \stackrel{\text{def}}{=} \vec{\Gamma}_{\text{arc}}^\times$ ,  $\vec{\Gamma}_v^\times \stackrel{\text{def}}{=} \vec{\Gamma}_{\text{arc}}^\times$ . Then for each vertex  $\nu$  of  $\vec{\Gamma}_v^\times$ , by assigning to “ $k$ ” or “ $\mathcal{O}_k^\triangleright$ ” (i.e., depending on the choice of  $\mathbb{T} \in \{\mathbb{T}\mathbb{F}, \mathbb{T}\mathbb{M}\}$ ) the object at the vertex  $\nu$  of the diagram of (v), we obtain a natural functor  $\mathcal{C}_{\mathbb{T}}^{\text{hol}} \rightarrow \mathcal{C}_{\mathbb{T}\mathbb{H}\mathbb{H}}^{\text{hol}}$ , hence by considering the portion of the panalocal or global or  $\mathbb{T}$ -pair under consideration that is indexed by  $v$  or  $\bar{v} \in \bar{V}$  lying over  $v$ , a *natural functor*  $\lambda_{v,\nu}^{\boxplus} : \mathfrak{H}_{\mathbb{T}}^\bullet[Z] \rightarrow \mathcal{N}_v^{\boxplus}$ . In a similar vein, if  $\nu$  is either the *space-link* or the *post-log* vertex of  $\vec{\Gamma}_v^{\text{log}}$ , then by assigning to “ $k$ ” or “ $\mathcal{O}_k^\triangleright$ ” the *underlying additive topological group* of the field “ $k$ ” (cf. the *functorial algorithms* of Corollary 2.7, as applied in Proposition 4.2, (ii)), we obtain a *natural functor*  $\mathcal{C}_{\mathbb{T}}^{\text{hol}} \rightarrow \mathcal{C}_{\mathbb{T}\mathbb{H}\mathbb{H}}^{\text{hol}}$ , hence by considering the portion of the panalocal or global  $\mathbb{T}$ -pair under consideration that is indexed by  $v$  or  $\bar{v} \in \bar{V}$  lying over  $v$ , a *natural functor*  $\lambda_{v,\nu}^{\boxplus} : \mathfrak{H}_{\mathbb{T}}^\bullet[Z] \rightarrow \mathcal{N}_v^{\boxplus}$ . Thus, in summary, we obtain *natural functors*

$$\lambda_{v,\nu}^{\boxplus} : \mathfrak{H}_{\mathbb{T}}^\bullet[Z] \rightarrow \mathcal{N}_v^{\boxplus}; \quad \lambda_{v,\nu} : \mathfrak{H}_{\mathbb{T}}^\bullet[Z] \rightarrow \mathcal{N}_v$$

— where the latter functor is obtained by composing the former functor with the natural functor  $\mathcal{N}_v^{\boxplus} \rightarrow \mathcal{N}_v$  — that “lie over”  $\mathfrak{H}^\bullet[Z]$ , for each *vertex*  $\nu$  of  $\vec{\Gamma}_v^{\text{log}}$ .

(vii) Finally, in the notation of (iv) (respectively, (vi)) for  $v \in V^{\text{non}}$  (respectively,  $v \in V^{\text{arc}}$ ): For each *edge*  $\epsilon$  of  $\vec{\Gamma}_v^\times$  (respectively,  $\vec{\Gamma}_v^{\text{log}}$ ) running from a *vertex*  $\nu_1$  to a *vertex*  $\nu_2$ , the arrow in the diagram of (iii) (respectively, (v)) corresponding to  $\epsilon$  determines a *natural transformation*

$$\iota_{v,\epsilon}^{\boxplus} : \lambda_{v,\nu_1}^{\boxplus} \circ \Lambda_{\nu_1} \rightarrow \lambda_{v,\nu_2}^{\boxplus} \quad (\text{respectively, } \iota_{v,\epsilon} : \lambda_{v,\nu_1} \circ \Lambda_{\nu_1} \rightarrow \lambda_{v,\nu_2})$$

— where, for each *pre-log* vertex  $\nu$  of  $\bar{\Gamma}_v^{\log}$ , we take  $\Lambda_\nu$  to be the *identity functor* on  $\mathfrak{H}_{\mathbb{T}}^\bullet[Z]$ ; for the *post-log* vertex  $\nu$  of  $\bar{\Gamma}_v^{\log}$ , we take  $\Lambda_\nu$  to be the *log-Frobenius functor*  $\log_{\mathbb{T}, \mathbb{T}}^\bullet : \mathfrak{H}_{\mathbb{T}}^\bullet[Z] \rightarrow \mathfrak{H}_{\mathbb{T}}^\bullet[Z]$ .

REMARK 5.4.1. Note that the *diagrams* of Definition 5.4, (iii), (v), (hence also the *natural transformations* of Definition 5.4, (vii)) *cannot be extended to global number fields!* Indeed, this observation is, in essence, a reflection of the fact that the various *logarithms* that may be defined at the various completions of a number field do *not* induce maps from, say, the group of units of the number field to the number field!

REMARK 5.4.2. Note that in the context of Definition 5.4, (iii), when  $k$  is *not absolutely unramified*, the “*gap*” between  $\mathcal{O}_{k^\sim}^{\Pi_k}$  and  $\mathcal{I}$  may be bounded in terms of the *ramification index* of  $k$  over  $\mathbb{Q}_{p_k}$ . We leave the routine details to the interested reader.

REMARK 5.4.3. The inclusions “ $\mathcal{O}_{k^\sim}^{\Pi_k} \subseteq \mathcal{I}$ ”, “ $\mathcal{O}_{k^\sim} \subseteq \mathcal{I}$ ” of Definition 5.4, (iii), (v), may be thought of as inclusions, within the *log-shell*  $\mathcal{I}$ , of the various *localizations* of the *trivial  $\boxplus$ -line bundle* of Definition 5.3, (ii) — an  $\boxplus$ -line bundle whose structure is determined by the *global ring of integers* (i.e., “ $\mathcal{O}_{M^\circ}$ ” in the notation of Definition 5.3, (ii)), equipped its natural *metrics* at the archimedean primes. That is to say, the definition of the trivial  $\boxplus$ -line bundle involves, in an essential way, not just the *additive* (i.e., “ $\boxplus$ ”) structure of the global ring of integers, but also the *multiplicative* (i.e., “ $\boxtimes$ ”) structure of the global ring of integers.

Next, we consider the following *global/panalocal analogue* of Corollaries 3.6, 4.5.

COROLLARY 5.5 (Global and Panalocal Mono-anabelian Log-Frobenius Compatibility). *Let  $Z$  be an elliptically admissible hyperbolic orbicurve over an algebraic closure of  $\mathbb{Q}$ , with field of moduli  $F^{\text{mod}}$  (cf. Definition 5.1, (ii));  $\mathbb{T} \in \{\text{TF}, \text{TM}\}$ ;  $\bullet \in \{\circ, \boxtimes\}$ . Set  $\mathcal{X} \stackrel{\text{def}}{=} \mathfrak{H}_{\mathbb{T}}^\bullet[Z]$ ,  $\mathcal{E} \stackrel{\text{def}}{=} \mathfrak{H}^\bullet[Z]$ .*

Consider the diagram of categories  $\mathcal{D}^\bullet$

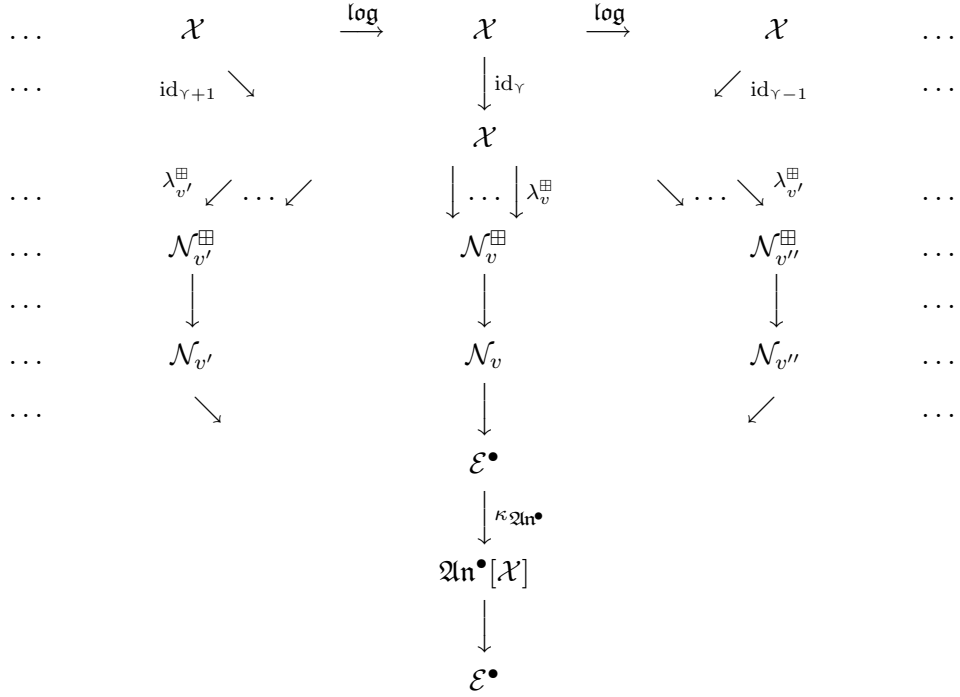

— where we use the notation “log” for the evident restriction of the arrows “ $\text{log}_{\mathbb{T}, \mathbb{T}^\bullet}$ ” of Definition 5.4, (ii); for positive integers  $n \leq 7$ , we shall denote by  $\mathcal{D}_{\leq n}^\bullet$  the subdiagram of categories of  $\mathcal{D}^\bullet$  determined by the first  $n$  (of the seven) rows of  $\mathcal{D}^\bullet$ ; we write  $L$  for the countably ordered set determined (cf. §0) by the infinite linear oriented graph  $\bar{\Gamma}_{\mathcal{D}^\bullet}^{\text{opp}_{\leq 1}}$  (so the elements of  $L$  correspond to vertices of the first row of  $\mathcal{D}^\bullet$ ) and

$$L^\dagger \stackrel{\text{def}}{=} L \cup \{\square\}$$

for the ordered set obtained by appending to  $L$  a formal symbol  $\square$  (which we think of as corresponding to the unique vertex of the second row of  $\mathcal{D}^\bullet$ ) such that  $\square < \Upsilon$ , for all  $\Upsilon \in L$ ;  $\text{id}_\Upsilon$  denotes the identity functor at the vertex  $\Upsilon \in L$ ; the vertices of the third and fourth rows of  $\mathcal{D}^\bullet$  are indexed by the elements  $v', v, v'', \dots$  of the set of valuations  $\mathbb{V}(F^{\text{mod}})$  of  $F^{\text{mod}}$ ; the arrows from the second row to the category  $\mathcal{N}_v^\boxplus$  in the third row are given by the collection of functors  $\lambda_v^\boxplus \stackrel{\text{def}}{=} \{\lambda_{v, \nu}^\boxplus\}_\nu$  of Definition 5.4, (iv), (vi), where  $\nu$  ranges over the

pre-log vertices of  $\vec{\Gamma}_v^{\log}$  (or, alternatively, over all the vertices of  $\vec{\Gamma}_v^{\log}$ , subject to the proviso that we identify the functors associated to the space-link and post-log vertices); the arrows from the third to fourth and from the fourth to fifth rows are the natural functors  $\mathcal{N}_v^{\boxplus} \rightarrow \mathcal{N}_v \rightarrow \mathcal{E}^\bullet$  of Definition 5.4, (iv), (vi); the arrows from the fifth to sixth and from the sixth to seventh rows are the natural equivalences of categories  $\mathcal{E}^\bullet \xrightarrow{\sim} \mathfrak{A}n^\bullet[\mathcal{X}] \xrightarrow{\sim} \mathcal{E}^\bullet$ , the first of which we shall denote by  $\kappa_{\mathfrak{A}n^\bullet}$ , of Corollary 5.2, (i), (iv), (vii) (cf. also Remark 5.2.2), restricted to “[Z]”; we shall apply “[−]” to the names of arrows appearing in  $\mathcal{D}^\bullet$  to denote the path of length 1 associated to the arrow. Also, let us write

$$\phi_{\mathfrak{A}n^\bullet} : \mathfrak{A}n^\bullet[\mathcal{X}] \xrightarrow{\sim} \mathcal{X}$$

for the equivalence of categories given by the “forgetful functor” of Corollary 5.2, (iv), (vii), restricted to “[Z]”,  $\pi_{\mathfrak{A}n^\bullet} : \mathcal{X} \rightarrow \mathfrak{A}n^\bullet[\mathcal{X}]$  for the quasi-inverse for  $\phi_{\mathfrak{A}n^\bullet}$  given by the composite of the natural projection functor  $\mathcal{X} \rightarrow \mathcal{E}^\bullet$  with  $\kappa_{\mathfrak{A}n^\bullet} : \mathcal{E}^\bullet \rightarrow \mathfrak{A}n^\bullet[\mathcal{X}]$ , and  $\eta_{\mathfrak{A}n^\bullet} : \phi_{\mathfrak{A}n^\bullet} \circ \pi_{\mathfrak{A}n^\bullet} \xrightarrow{\sim} \text{id}_{\mathcal{X}}$  for the isomorphism that exhibits  $\phi_{\mathfrak{A}n^\bullet}$ ,  $\pi_{\mathfrak{A}n^\bullet}$  as quasi-inverses to one another. Then:

(i) For  $n = 5, 6, 7$ ,  $\mathcal{D}_{\leq n}^\bullet$  admits a natural structure of core on  $\mathcal{D}_{\leq n-1}^\bullet$ . That is to say, loosely speaking,  $\mathcal{E}^\bullet$ ,  $\mathfrak{A}n^\bullet[\mathcal{X}]$  “form cores” of the functors in  $\mathcal{D}$ . If, moreover,  $\bullet = \odot$ , then one obtains a natural structure of core on  $\mathcal{D}^\bullet$  by appending to the final row of  $\mathcal{D}^\bullet$  the natural arrow  $\mathcal{E}^\bullet \rightarrow \mathbb{E}A^\odot[Z]$ .

(ii) The “forgetful functor”  $\phi_{\mathfrak{A}n^\bullet}$  gives rise to a telecore structure  $\mathfrak{T}_{\mathfrak{A}n^\bullet}$  on  $\mathcal{D}_{\leq 5}^\bullet$ , whose underlying diagram of categories we denote by  $\mathcal{D}_{\mathfrak{A}n^\bullet}$ , by appending to  $\mathcal{D}_{\leq 6}^\bullet$  telecore edges

$$\begin{array}{ccccccc}
 & & & \mathfrak{A}n^\bullet[\mathcal{X}] & & & \\
 \dots & & \phi_{\gamma+1} \swarrow & \downarrow \phi_\gamma & \searrow \phi_{\gamma-1} & & \dots \\
 \dots & & \mathcal{X} & \xrightarrow{\log} & \mathcal{X} & \xrightarrow{\log} & \mathcal{X} & \dots \\
 & & & \mathfrak{A}n^\bullet[\mathcal{X}] & \xrightarrow{\phi_\square} & \mathcal{X} & & 
 \end{array}$$

from the core  $\mathfrak{A}n^\bullet[\mathcal{X}]$  to the various copies of  $\mathcal{X}$  in  $\mathcal{D}_{\leq 2}^\bullet$  given by copies of  $\phi_{\mathfrak{A}n^\bullet}$ , which we denote by  $\phi_\lambda$ , for  $\lambda \in L^\dagger$ . That is to say, loosely speaking,  $\phi_{\mathfrak{A}n^\bullet}$  determines a telecore structure on  $\mathcal{D}_{\leq 5}^\bullet$ . Finally, for each  $\lambda \in L^\dagger$ , let us write  $[\beta_\lambda^0]$  for the path on  $\vec{\Gamma}_{\mathcal{D}_{\mathfrak{A}n^\bullet}}$  of length 0 at  $\lambda$  and  $[\beta_\lambda^1]$  for some (cf.

the coricity of (i)!) path on  $\vec{\Gamma}_{\mathcal{D}\mathfrak{An}^\bullet}$  of length  $\in \{5, 6\}$  (i.e., depending on whether or not  $\lambda = \square$ ) that starts from  $\lambda$ , descends via some path of length  $\in \{4, 5\}$  to the core vertex “ $\mathfrak{An}^\bullet[\mathcal{X}]$ ”, and returns to  $\lambda$  via the telecore edge  $\phi_\lambda$ . Then the collection of natural transformations

$$\{\eta_{\square\Upsilon}, \eta_{\square\Upsilon}^{-1}, \eta_\lambda, \eta_\lambda^{-1}\}_{\Upsilon \in L, \lambda \in L^\dagger}$$

— where we write  $\eta_{\square\Upsilon}$  for the identity natural transformation from the arrow  $\phi_\square : \mathfrak{An}^\bullet[\mathcal{X}] \rightarrow \mathcal{X}$  to the composite arrow  $\text{id}_\Upsilon \circ \phi_\Upsilon : \mathfrak{An}^\bullet[\mathcal{X}] \rightarrow \mathcal{X}$  and

$$\eta_\lambda : (\mathcal{D}\mathfrak{An}^\bullet)_{[\beta_\lambda^1]} \xrightarrow{\sim} (\mathcal{D}\mathfrak{An}^\bullet)_{[\beta_\lambda^0]}$$

for the isomorphism arising from  $\eta_{\mathfrak{An}^\bullet}$  — generate a contact structure  $\mathcal{H}_{\mathfrak{An}^\bullet}$  on the telecore  $\mathfrak{T}_{\mathfrak{An}^\bullet}$ .

(iii) The natural transformations (cf. Definition 5.4, (vii))

$$\iota_{v,\epsilon}^\boxplus : \lambda_{v,\nu_1}^\boxplus \circ \Lambda_{\nu_1} \rightarrow \lambda_{v,\nu_2}^\boxplus \quad (\text{respectively, } \iota_{v,\epsilon} : \lambda_{v,\nu_1} \circ \Lambda_{\nu_1} \rightarrow \lambda_{v,\nu_2})$$

— where  $v \in \mathbb{V}(F^{\text{mod}})$ ;  $\epsilon$  is an edge of  $\vec{\Gamma}_v^\times$  (respectively,  $\vec{\Gamma}_v^{\text{log}}$ ) running from a vertex  $\nu_1$  to a vertex  $\nu_2$ ; if  $\nu_1$  is a pre-log vertex, then we interpret the domain and codomain of  $\iota_{v,\epsilon}^\boxplus$  (respectively,  $\iota_{v,\epsilon}$ ) as the arrows associated to the paths of length 1 (respectively, 2) from the second to third (respectively, fourth) rows of  $\mathcal{D}^\bullet$  determined by  $v$  and  $\nu_1, \nu_2$ ; if  $\nu_1$  is a post-log vertex, then we interpret the domain of  $\iota_{v,\epsilon}^\boxplus$  (respectively,  $\iota_{v,\epsilon}$ ) as the arrow associated to the path of length 3 (respectively, 4) from the first to the third (respectively, fourth) rows of  $\mathcal{D}^\bullet$  determined by  $v, \nu_1$ , and the condition that the initial length 2 portion of the path be a path of the form  $[\text{id}_\Upsilon] \circ [\text{log}]$  (for  $\Upsilon \in L$ ), and we interpret the codomain of  $\iota_{v,\epsilon}^\boxplus$  (respectively,  $\iota_{v,\epsilon}$ ) as the arrow associated to the path of length 2 (respectively, 3) from the first to the third (respectively, fourth) rows of  $\mathcal{D}^\bullet$  determined by  $v, \nu_2$ , and the condition that the initial length 1 portion of the path be a path of the form  $[\text{id}_{\Upsilon+1}]$  (for the same  $\Upsilon \in L$ ) — belong to a family of homotopies on  $\mathcal{D}_{\leq 3}^\bullet$  (respectively,  $\mathcal{D}_{\leq 4}^\bullet$ ) that determines on the portion of  $\mathcal{D}_{\leq 3}^\bullet$  (respectively,  $\mathcal{D}_{\leq 4}^\bullet$ ) indexed by  $v$  a structure of observable  $\mathfrak{S}_{\text{log}\boxplus}$  (respectively,  $\mathfrak{S}_{\text{log}}$ ) on  $\mathcal{D}_{\leq 2}^\bullet$  (respectively, the portion of  $\mathcal{D}_{\leq 3}^\bullet$  indexed by  $v$ ). Moreover, the families of homotopies that constitute  $\mathfrak{S}_{\text{log}}$  and  $\mathfrak{S}_{\text{log}\boxplus}$  are compatible with one another as well as with the families of homotopies that constitute the core and telecore structures of (i), (ii).

(iv) The diagram of categories  $\mathcal{D}_{\leq 2}^\bullet$  does not admit a structure of core on  $\mathcal{D}_{\leq 1}^\bullet$  which (i.e., whose constituent family of homotopies) is compatible with (the constituent family of homotopies of) the observables  $\mathfrak{S}_{\log}, \mathfrak{S}_{\log\boxplus}$  of (iii). Moreover, the telecore structure  $\mathfrak{T}_{\mathfrak{A}n^\bullet}$  of (ii), the contact structure  $\mathcal{H}_{\mathfrak{A}n^\bullet}$  of (ii), and the observables  $\mathfrak{S}_{\log}, \mathfrak{S}_{\log\boxplus}$  of (iii) are not simultaneously compatible.

(v) The unique vertex  $\square$  of the second row of  $\mathcal{D}^\bullet$  is a nexus of  $\vec{\Gamma}_{\mathcal{D}^\bullet}^\bullet$ . Moreover,  $\mathcal{D}^\bullet$  is totally  $\square$ -rigid, and the natural action of  $\mathbb{Z}$  on the infinite linear oriented graph  $\vec{\Gamma}_{\mathcal{D}_{\leq 1}^\bullet}^\bullet$  extends to an action of  $\mathbb{Z}$  on  $\mathcal{D}^\bullet$  by nexus-classes of self-equivalences of  $\mathcal{D}^\bullet$ . Finally, the self-equivalences in these nexus-classes are compatible with the families of homotopies that constitute the cores and observables of (i), (iii); these self-equivalences also extend naturally (cf. the technique of extension applied in Definition 3.5, (vi)) to the diagram of categories (cf. Definition 3.5, (iv), (a)) that constitutes the telecore of (ii), in a fashion that is compatible with both the family of homotopies that constitutes this telecore structure (cf. Definition 3.5, (iv), (b)) and the contact structure  $\mathcal{H}_{\mathfrak{A}n^\bullet}$  of (ii).

(vi) There is a natural panalocalization morphism of diagrams of categories

$$\mathcal{D}^\circlearrowleft \rightarrow \mathcal{D}^{\boxtimes}$$

(cf. the panalocalization functors of Definition 5.1, (iv), (vi)) that lies over the evident isomorphism of oriented graphs  $\vec{\Gamma}_{\mathcal{D}^\circlearrowleft}^\circlearrowleft \xrightarrow{\sim} \vec{\Gamma}_{\mathcal{D}^{\boxtimes}}^{\boxtimes}$  and is compatible with the cores of (i), the telecore and contact structures of (ii), the observables of (iii), and the  $\mathbb{Z}$ -actions of (v).

PROOF. Assertions (i), (ii) are immediate from the definitions — cf. also the proofs of Corollary 3.6, (i), (ii); Corollary 4.5, (i), (ii). Next, we consider assertion (iii). The data arising from applying the collection of functors  $\lambda_\nu \stackrel{\text{def}}{=} \{\lambda_{\nu,\nu}\}_\nu$  to the data arising from  $\text{id}_\Upsilon$ , as  $\Upsilon$  ranges over the elements of  $L$ , yields a *diagram* of copies of  $\vec{\Gamma}_v^{\log}$  indexed by elements of  $L$

$$\dots \Vdash (\vec{\Gamma}_v^{\log})_{\Upsilon+1} \Vdash (\vec{\Gamma}_v^{\log})_\Upsilon \Vdash (\vec{\Gamma}_v^{\log})_{\Upsilon-1} \Vdash \dots$$

— where the symbol “ $\Vdash$ ” denotes the result of *gluing*  $(\vec{\Gamma}_v^{\log})_{\Upsilon+1}$  onto  $(\vec{\Gamma}_v^{\log})_\Upsilon$  by *identifying* the *post-log* vertex of  $(\vec{\Gamma}_v^{\log})_{\Upsilon+1}$  with the *space-link* vertex of  $(\vec{\Gamma}_v^{\log})_\Upsilon$ . Now the existence of a *family of homotopies* as asserted follows, in



a routine fashion, from the fact that the above diagram is *commutative* (i.e., one does not obtain any pairs of *distinct maps* by traveling along distinct co-vertical pairs of paths of the diagram) — cf. the relationship of the diagrams

$$\begin{array}{cccccccc} \dots & \leftarrow & \bar{k}_{\gamma+1}^\times & \rightarrow & (\bar{k}_{\gamma+1}^\times)^{\text{Pf}} & \leftarrow & \bar{k}_\gamma^\times & \rightarrow & (\bar{k}_\gamma^\times)^{\text{Pf}} & \leftarrow & \dots \\ \dots & \leftarrow & k_{\gamma+1}^\times & \leftarrow & k_{\gamma+1}^\sim & \leftarrow & k_\gamma^\times & \leftarrow & k_\gamma^\sim & \leftarrow & \dots \end{array}$$

of Remarks 3.6.1, (i); 4.5.1, (i), to the proofs of assertion (iii) of Corollaries 3.6, 4.5; we leave the routine details (which are entirely similar to the proofs of assertion (iii) of Corollaries 3.6, 4.5) to the reader. Finally, the *compatibility* of the resulting family of homotopies with the families of homotopies that constitute the core and telecore structures of (i), (ii) is immediate from the definitions. This completes the proof of assertion (iii).

Next, we consider assertion (iv). Recall that the proofs of the incompatibility assertions of assertion (iv) of Corollaries 3.6, 4.5 amount, in essence, to the *incompatibility* of the introduction of a *single model* that maps isomorphically to various copies of the model indexed by elements of  $L$  in the diagrams of Remarks 3.6.1, (i); 4.5.1, (i). In the present situation, the incompatibility assertions of assertion (iv) of the present Corollaries 5.5 amount, in an entirely similar fashion, to the *incompatibility* of the introduction of a *single model*  $(\vec{\Gamma}_v^{\text{log}})_\square$  of  $\vec{\Gamma}_v^{\text{log}}$  that maps *isomorphically*

$$\begin{array}{ccccccc} & & & (\vec{\Gamma}_v^{\text{log}})_\square & & & \\ \dots & & \swarrow & \downarrow & \searrow & & \dots \\ \dots & \Vdash & (\vec{\Gamma}_v^{\text{log}})_{\gamma+1} & \Vdash & (\vec{\Gamma}_v^{\text{log}})_\gamma & \Vdash & (\vec{\Gamma}_v^{\text{log}})_{\gamma-1} & \Vdash & \dots \end{array}$$

to each copy  $(\vec{\Gamma}_v^{\text{log}})_\gamma$  that appears in the diagram that was used in the proof of assertion (iii). We leave the routine details (which are entirely similar to the proofs of assertion (iv) of Corollaries 3.6, 4.5) to the reader. This completes the proof of assertion (iv).

Next, we consider assertion (v). The fact that  $\square$  is a *nexus* of  $\vec{\Gamma}_\mathcal{D}^\bullet$  is immediate from the definitions. When  $\bullet = \odot$ , the *total  $\square$ -rigidity* of  $\mathcal{D}^\bullet$  follows immediately from the *equivalence of categories*  $\mathfrak{Th}_\mathbb{T}^\odot \xrightarrow{\sim} \mathbb{EA}^\odot$  of Corollary 5.2, (iv), together with the *slimness* of the profinite groups that appear as objects of  $\mathbb{EA}^\odot$  (cf., e.g., [Mzk20], Proposition 2.3, (ii)). When

$\bullet = \boxtimes$ , the *total  $\square$ -rigidity* of  $\mathcal{D}^\bullet$  follows, in light of the “*Kummer theory*” of Propositions 3.2, (iv); 4.2, (i), from the fact that the *orbi-objects* that appear in the definition of a *panalocal Galois-theater* are *defined* in such a way as to *eliminate all the automorphisms* (cf. Definition 5.1, (iv), (b), (c)). The remainder of assertion (v) is immediate from the definitions and constructions made thus far. This completes the proof of assertion (v). Finally, we observe that assertion (vi) is immediate from the definitions and constructions made thus far.  $\square$

REMARK 5.5.1. The “*general formal content*” of the remarks following Corollaries 3.6, 3.7 applies to the situation discussed in Corollary 5.5, as well. We leave the routine details of translating these remarks into the language of the situation of Corollary 5.5 to the interested reader.

REMARK 5.5.2. Note that it does not appear realistic to attempt to construct a theory of “*geometric panalocalization*” with respect to the various *closed points of the hyperbolic orbicurve* over an MLF under consideration (cf. the discussion of Remarks 1.11.5; 3.7.7, (ii)). Indeed, the decomposition groups of such closed points (which are either isomorphic to the absolute Galois group of an MLF or an extension of such an absolute Galois group by a copy of  $\widehat{\mathbb{Z}}(1)$ ) do not satisfy an appropriate analogue of the crucial *mono-anabelian* result Corollary 1.10 (hence, in particular, do not lead to a situation in which *both* of the two combinatorial dimensions of the absolute Galois group of an MLF under consideration are *rigidified* — cf. Remark 1.9.4).

DEFINITION 5.6.

(i) Recall the *categories*  $\mathrm{TG}$ ,  $\mathrm{TM}$ , and  $\mathrm{TS}$  of Definition 3.1, (i), (iii). Write

$$\mathrm{TG}^+ \subseteq \mathrm{TG}$$

for the *subcategory* given by the profinite groups isomorphic to the *absolute Galois group of an MLF* and open injections of profinite groups, and

$$\mathrm{TG}^{\mathrm{CS}} \subseteq \mathrm{Orb}(\mathrm{TG})$$

for the *full subcategory* determined by the (“*coarsified*”) objects of  $\mathrm{Orb}(\mathrm{TG})$  obtained by considering an object  $G \in \mathrm{Ob}(\mathrm{TG})$  up to its group of automorphisms  $\mathrm{Aut}_{\mathrm{TG}}(G)$ . Write

$$\mathrm{TM}^+$$

for the category whose *objects*  $(C, \overrightarrow{C})$  consist of a topological monoid  $C$  isomorphic to  $\mathcal{O}_{\mathbb{C}}^{\widehat{\phantom{C}}}$  and a topological submonoid  $\overrightarrow{C} \subseteq C$  (necessarily isomorphic to  $\mathbb{R}_{\geq 0}$ ) such that the natural inclusions  $C^\times \hookrightarrow C$  (where  $C^\times$ , which is necessarily isomorphic to  $\mathbb{S}^1$ , denotes the topological submonoid of *invertible elements*),  $\overrightarrow{C} \hookrightarrow C$  determine an isomorphism

$$C^\times \times \overrightarrow{C} \xrightarrow{\sim} C$$

of topological monoids, and whose *morphisms*  $(C_1, \overrightarrow{C}_1) \rightarrow (C_2, \overrightarrow{C}_2)$  are isomorphisms of topological monoids  $C_1 \xrightarrow{\sim} C_2$  that induce isomorphisms  $\overrightarrow{C}_1 \xrightarrow{\sim} \overrightarrow{C}_2$ . If  $G \in \text{Ob}(\mathbb{T}\mathbb{G})$ , then let us write

$$\mathfrak{L}\mathfrak{ie}(G)$$

for the associated *group germ* — i.e., the associated group pro-object of  $\mathbb{T}\mathbb{S}$  determined by the neighborhoods of the identity element — and, when  $G$  is *abelian*,  $\mathfrak{L}\mathfrak{ie}^\pm(G)$  for the orbi-group germ obtained by working with  $\mathfrak{L}\mathfrak{ie}(G)$  up to “ $\{\pm 1\}$ ”. Write

$$\mathbb{T}\mathbb{B}\boxplus$$

for the category whose *objects*  $(B, B', B'', \beta)$  consist of a two-dimensional connected topological Lie group  $B$  equipped with two one-parameter subgroups  $B', B'' \subseteq B$  that determine an isomorphism

$$B' \times B'' \xrightarrow{\sim} B$$

of topological groups, together with an isomorphism  $\beta : \mathfrak{L}\mathfrak{ie}^\pm(B') \xrightarrow{\sim} \mathfrak{L}\mathfrak{ie}^\pm(B'')$ , and whose *morphisms*  $(B_1, B'_1, B''_1, \beta_1) \rightarrow (B_2, B'_2, B''_2, \beta_2)$  are the surjective homomorphisms  $B_1 \rightarrow B_2$  of topological groups that are *compatible* with the  $B'_i, B''_i, \beta_i$  for  $i = 1, 2$ . Write  $\mathbb{T}\mathbb{B}$  for the category of *orientable topological orbisurfaces* (i.e., which are topological surfaces over the complement, in the “coarse space” associated to the orbisurface, of some *discrete closed subset*) and local isomorphisms between such orbisurfaces. Thus, we obtain natural “*forgetful functors*”

$$\mathbb{T}\mathbb{M}^\dagger \rightarrow \mathbb{T}\mathbb{M}; \quad \mathbb{T}\mathbb{B}\boxplus \rightarrow \mathbb{T}\mathbb{B}$$

determined by the assignments  $(C, \overrightarrow{C}) \mapsto C, (B, B', B'', \beta) \mapsto B$ , as well as natural “*decomposition functors*”

$$\text{dec}_{\mathbb{T}\mathbb{M}^\dagger} : \mathbb{T}\mathbb{M}^\dagger \rightarrow \mathbb{T}\mathbb{G} \times \mathbb{T}\mathbb{G}^{\text{cs}}; \quad \text{dec}_{\mathbb{T}\mathbb{B}\boxplus} : \mathbb{T}\mathbb{B}\boxplus \rightarrow \mathbb{T}\mathbb{G} \times \mathbb{T}\mathbb{G}^{\text{cs}}$$

determined by the assignments  $(C, \overrightarrow{C}) \mapsto (C^\times, (\overrightarrow{C}^{\text{gp}})^{\text{cs}})$ ,  $(B, B', B'', \beta) \mapsto (B', (B'')^{\text{cs}})$  (where “gp” denotes the *groupification* of a monoid; “cs” denotes the result of considering a topological group up to its group of automorphisms).

(ii) We shall refer to as a *mono-analytic Galois-theater* any collection of data

$$\mathcal{W}^+ \stackrel{\text{def}}{=} (W^\circ, \{(G_w, |\Pi|_w)\}_{w \in W^{\text{non}}}, \{(G_w, |\mathbb{X}|_w)\}_{w \in W^{\text{arc}}})$$

— where  $W^\circ$  is a set that admits a decomposition as a disjoint union  $W^\circ = \{\circlearrowleft_W\} \cup W^{\text{non}} \cup W^{\text{arc}} \supseteq W \stackrel{\text{def}}{=} W^{\text{non}} \cup W^{\text{arc}}$ ; for each  $w \in W^{\text{non}}$ ,  $G_w \in \text{Ob}(\text{Orb}(\mathbb{TG}^+))$ , and  $|\Pi|_w$  is an *isomorphism class* of pro-objects of the category  $\mathbb{TG}$ ; for each  $w \in W^{\text{arc}}$ ,  $G_w \in \text{Ob}(\text{Orb}(\mathbb{TM}^+))$ , and  $|\mathbb{X}|_w$  is an *isomorphism class* of  $\mathbb{EA}$  — such that there exists a *panalocal Galois-theater*

$$\mathcal{V}^\times \stackrel{\text{def}}{=} (V^\circ, \{\Pi_v\}_{v \in V^{\text{non}}}, \{\mathbb{X}_v\}_{v \in V^{\text{arc}}})$$

(cf. the notation of Definition 5.1, (iv)) and an *isomorphism of sets*

$$\psi_W : V^\circ \xrightarrow{\sim} W^\circ$$

— which we shall refer to as a *reference isomorphism* for  $\mathcal{W}^+$  — that satisfies the following conditions: (a)  $\psi_W$  maps  $\circlearrowleft_V \mapsto \circlearrowleft_W$ ,  $V^{\text{non}} \xrightarrow{\sim} W^{\text{non}}$ ,  $V^{\text{arc}} \xrightarrow{\sim} W^{\text{arc}}$ ; (b) for each  $v \in V^{\text{non}}$  mapping to  $w \in W^{\text{non}}$ ,  $G_w$  is isomorphic to the (*group-theoretically characterizable* — cf. Remark 1.9.2) quotient  $\Pi_v \twoheadrightarrow G_v$  determined by the *absolute Galois group* of the base field, and the class  $|\Pi|_w$  contains the pro-object of  $\mathbb{TG}$  determined by the projective system of open subgroups of  $\Pi_v$  arising from open subgroups of  $G_v$ ; (c) for each  $v \in V^{\text{arc}}$  mapping to  $w \in W^{\text{arc}}$ ,  $\mathbb{X}_v$  belongs to the class  $|\mathbb{X}|_w$ , and  $G_w$  is isomorphic to the object of  $\mathbb{TM}^+$  determined by  $(\mathcal{O}_{\mathbb{A}_{\mathbb{X}_v}}^\geq, \mathcal{O}_{\mathbb{A}_{\mathbb{X}_v}}^\geq \cap \mathbb{R}_{>0})$ . A *morphism of mono-analytic Galois-theaters*

$$\begin{aligned} \phi : (W_1^\circ, \{((G_1)_{w_1}, |\Pi|_{w_1})\}_{w_1 \in W_1^{\text{non}}}, \{((G_1)_{w_1}, |\mathbb{X}|_{w_1})\}_{w_1 \in W_1^{\text{arc}}}) \\ \rightarrow (W_2^\circ, \{((G_2)_{w_2}, |\Pi|_{w_2})\}_{w_2 \in W_2^{\text{non}}}, \{((G_2)_{w_2}, |\mathbb{X}|_{w_2})\}_{w_2 \in W_2^{\text{arc}}}) \end{aligned}$$

is defined to consist of a bijection of sets  $\phi_W : W_1^\circ \xrightarrow{\sim} W_2^\circ$  that induces bijections  $W_1^{\text{non}} \xrightarrow{\sim} W_2^{\text{non}}$ ,  $W_1^{\text{arc}} \xrightarrow{\sim} W_2^{\text{arc}}$  that are *compatible with the isomorphism classes*  $|\Pi|_{w_i}$ ,  $|\mathbb{X}|_{w_i}$  (for  $i = 1, 2$ ), together with open injections of (orbi-)profinite groups  $(G_1)_{w_1} \hookrightarrow (G_2)_{w_2}$  (where  $W_1^{\text{non}} \ni w_1 \mapsto w_2 \in W_2^{\text{non}}$ ), and

isomorphisms  $(G_1)_{w_1} \xrightarrow{\sim} (G_2)_{w_2}$  (where  $W_1^{\text{arc}} \ni w_1 \mapsto w_2 \in W_2^{\text{arc}}$ ). Write  $\mathfrak{Th}^\dagger$  for the category of *mono-analytic Galois-theaters* and morphisms of mono-analytic Galois-theaters. Thus, if  $Z$  is an *elliptically admissible* hyperbolic orbicurve over an algebraic closure of  $\mathbb{Q}$ , then we have a *full subcategory*  $\mathfrak{Th}^\dagger[Z] \subseteq \mathfrak{Th}^\dagger$ , together with natural “*mono-analyticization functors*”

$$\mathfrak{Th}^{\text{st}} \rightarrow \mathfrak{Th}^\dagger; \quad \mathfrak{Th}^{\text{st}}[Z] \rightarrow \mathfrak{Th}^\dagger[Z]$$

— which are *essentially surjective*.

(iii) Next, let us *fix* a *mono-analytic Galois-theater*  $\mathcal{W}^\dagger$  as in (ii), together with a  $w \in W^{\text{non}}$ . Recall the categories  $\mathcal{C}_{\mathbb{T}\mathbb{S}\boxplus}^{\text{MLF}^\dagger}$ ,  $\mathcal{C}_{\mathbb{T}\mathbb{S}}^{\text{MLF}^\dagger}$  of Definition 3.1, (iii). Thus, we have a (1-)commutative diagram of natural functors

$$\begin{array}{ccccc} \mathcal{C}_{\mathbb{T}\mathbb{S}\boxplus}^{\text{MLF-sB}} & \longrightarrow & \mathcal{C}_{\mathbb{T}\mathbb{S}}^{\text{MLF-sB}} & \longrightarrow & \text{TG}^{\text{sB}} \\ \downarrow & & \downarrow & & \downarrow \\ \mathcal{C}_{\mathbb{T}\mathbb{S}\boxplus}^{\text{MLF}^\dagger} & \longrightarrow & \mathcal{C}_{\mathbb{T}\mathbb{S}}^{\text{MLF}^\dagger} & \longrightarrow & \text{TG}^\dagger \end{array}$$

— in which the vertical arrows are “*mono-analyticization functors*” (cf. the mono-analyticization functors of (ii); the construction implicit in (ii), (b)); the arrows  $\mathcal{C}_{\mathbb{T}\mathbb{S}}^{\text{MLF-sB}} \rightarrow \text{TG}^{\text{sB}}$ ,  $\mathcal{C}_{\mathbb{T}\mathbb{S}}^{\text{MLF}^\dagger} \rightarrow \text{TG}^\dagger$  are the natural projection functors. Let us write

$$\begin{aligned} \mathcal{N}_w^{\dagger\boxplus} &\stackrel{\text{def}}{=} \text{Orb}(\mathcal{C}_{\mathbb{T}\mathbb{S}\boxplus}^{\text{MLF}^\dagger}) \times_{\text{Orb}(\text{TG}^\dagger), w} \mathfrak{Th}^\dagger[Z] \\ \mathcal{N}_w^\dagger &\stackrel{\text{def}}{=} \text{Orb}(\mathcal{C}_{\mathbb{T}\mathbb{S}}^{\text{MLF}^\dagger}) \times_{\text{Orb}(\text{TG}^\dagger), w} \mathfrak{Th}^\dagger[Z] \end{aligned}$$

— where the “ $w$ ” in the fibered product is to be understood as referring to the *natural functor*  $\mathfrak{Th}^\dagger[Z] \rightarrow \text{Orb}(\text{TG}^\dagger)$  given by the assignment “ $\mathcal{W}^\dagger \mapsto G_w$ ” (cf. (ii)). Thus, we have *natural functors*  $\mathcal{N}_w^{\dagger\boxplus} \rightarrow \mathcal{N}_w^\dagger \rightarrow \mathfrak{Th}^\dagger[Z]$ .

(iv) Next, let us *fix* a *mono-analytic Galois-theater*  $\mathcal{W}^\dagger$  as in (ii), together with a  $w \in W^{\text{arc}}$ . Recall the categories  $\mathcal{C}_{\mathbb{T}\mathbb{H}\boxplus}^{\text{hol}}$ ,  $\mathcal{C}_{\mathbb{T}\mathbb{H}}^{\text{hol}}$  of Definition 4.1, (iii). Write

$$\mathcal{C}_{\mathbb{T}\mathbb{B}\boxplus}^{\text{hol}\dagger}$$

for the category whose *objects* are triples  $(G, M, \kappa_M)$ , where  $G \in \text{Ob}(\text{TM}^\dagger)$ ,  $M \in \text{Ob}(\mathbb{T}\mathbb{B}\boxplus)$ , and  $\kappa_M : \text{dec}_{\mathbb{T}\mathbb{B}\boxplus}(M) \twoheadrightarrow \text{dec}_{\text{TM}^\dagger}(G)$  — which we shall refer to as the *Kummer structure* of the object — is a *pair of surjective homomorphisms* of  $\text{TG}$ ,  $\text{TG}^{\text{cs}}$ , and whose *morphisms*  $\phi : (G_1, M_1, \kappa_{M_1}) \rightarrow$

$(G_2, M_2, \kappa_{M_2})$  consist of an isomorphism  $\phi_G : G_1 \xrightarrow{\sim} G_2$  of  $\mathbb{T}\mathbb{M}^\dagger$  and a morphism  $\phi_M : M_1 \rightarrow M_2$  of  $\mathbb{T}\mathbb{B}\boxplus$  that are *compatible* with  $\kappa_{M_1}, \kappa_{M_2}$ ; write  $\mathcal{C}_{\mathbb{T}\mathbb{B}}^{\text{hol}^-} \stackrel{\text{def}}{=} \mathbb{T}\mathbb{M}^\dagger \times \mathbb{T}\mathbb{B}$ . Next:

Suppose that  $(\mathbb{X}_{\text{ell}} \overset{\kappa}{\curvearrowright} M_k) \in \text{Ob}(\mathcal{C}_{\mathbb{T}\mathbb{H}\boxplus}^{\text{hol}})$  (cf. Definition 4.1, (i)). Recall that the *Kummer structure* of  $(\mathbb{X}_{\text{ell}} \overset{\kappa}{\curvearrowright} M_k)$  consists of an Aut-holomorphic homomorphism from  $M_k$  to an isomorph of “ $\mathbb{C}^\times (\cong \mathbb{S}^1 \times \mathbb{R}_{>0})$ ”; observe that the *Aut-holomorphic automorphisms of  $\mathfrak{L}\text{ie}(\mathbb{C}^\times)$  of order 4* determine an isomorphism  $\mathfrak{L}\text{ie}^\pm(\mathbb{S}^1 \times \{1\}) \xrightarrow{\sim} \mathfrak{L}\text{ie}^\pm(\{1\} \times \mathbb{R}_{>0})$ . Thus, by pulling back to  $M_k$ , via the *Kummer structure* of  $(\mathbb{X}_{\text{ell}} \overset{\kappa}{\curvearrowright} M_k)$ , the two one-parameter subgroups “ $\mathbb{S}^1 \times \{1\}, \{1\} \times \mathbb{R}_{>0} \subseteq \mathbb{C}^\times$ ”, we obtain, in a natural way, an object of  $\mathcal{C}_{\mathbb{T}\mathbb{B}\boxplus}^{\text{hol}^-}$ .

In particular, we obtain a (1-)commutative diagram of natural functors

$$\begin{array}{ccccc} \mathcal{C}_{\mathbb{T}\mathbb{H}\boxplus}^{\text{hol}} & \longrightarrow & \mathcal{C}_{\mathbb{T}\mathbb{H}}^{\text{hol}} & \longrightarrow & \mathbb{E}\mathbb{A} \\ \downarrow & & \downarrow & & \downarrow \\ \mathcal{C}_{\mathbb{T}\mathbb{B}\boxplus}^{\text{hol}^-} & \longrightarrow & \mathcal{C}_{\mathbb{T}\mathbb{B}}^{\text{hol}^-} & \longrightarrow & \mathbb{T}\mathbb{M}^\dagger \end{array}$$

— in which the vertical arrows are “*mono-analyticization functors*” (cf. the mono-analyticization functors of (ii); the construction implicit in (ii), (c)); the arrows  $\mathcal{C}_{\mathbb{T}\mathbb{H}}^{\text{hol}} \rightarrow \mathbb{E}\mathbb{A}$ ,  $\mathcal{C}_{\mathbb{T}\mathbb{B}}^{\text{hol}^-} \rightarrow \mathbb{T}\mathbb{M}^\dagger$  are the natural projection functors. Let us write

$$\begin{aligned} \mathcal{N}_w^{\dagger\boxplus} &\stackrel{\text{def}}{=} \text{Orb}(\mathcal{C}_{\mathbb{T}\mathbb{B}\boxplus}^{\text{hol}^-}) \times_{\text{Orb}(\mathbb{T}\mathbb{M}^\dagger), w} \mathfrak{I}\mathfrak{h}^\dagger[Z] \\ \mathcal{N}_w^\dagger &\stackrel{\text{def}}{=} \text{Orb}(\mathcal{C}_{\mathbb{T}\mathbb{B}}^{\text{hol}^-}) \times_{\text{Orb}(\mathbb{T}\mathbb{M}^\dagger), w} \mathfrak{I}\mathfrak{h}^\dagger[Z] \end{aligned}$$

— where the “ $w$ ” in the fibered product is to be understood as referring to the *natural functor*  $\mathfrak{I}\mathfrak{h}^\dagger[Z] \rightarrow \text{Orb}(\mathbb{T}\mathbb{M}^\dagger)$  given by the assignment “ $\mathcal{W}^\dagger \mapsto G_w$ ” (cf. (ii)). Thus, we have *natural functors*  $\mathcal{N}_w^{\dagger\boxplus} \rightarrow \mathcal{N}_w^\dagger \rightarrow \mathfrak{I}\mathfrak{h}^\dagger[Z]$ .

REMARK 5.6.1.

(i) Observe that a *monoid*  $M$  may be thought of as a (1-)category  $\mathcal{C}_M$  consisting of a single object whose monoid of endomorphisms is given by  $M$ . In a similar vein, a *ring*  $R$ , whose underlying *additive group* we denote by  $R_\boxplus$ , may be thought of as a 2-category consisting of the single 1-category

$\mathcal{C}_{R_{\boxplus}}$ , together with the functors  $\mathcal{C}_{R_{\boxplus}} \rightarrow \mathcal{C}_{R_{\boxplus}}$  arising from left multiplication by elements of  $R$ .

(ii) The constructions of (i) suggest that whereas a *monoid* may be thought of as a mathematical object with “*one combinatorial dimension*”, a *ring* should be thought of as a mathematical object with “*two combinatorial dimensions*”. Moreover, in the case of an MLF  $k$ , these two combinatorial dimensions may be thought of as corresponding to the *two cohomological dimensions* of the absolute Galois group of  $k$ , while in the case of a CAF  $k$ , these two combinatorial dimensions may be thought of as corresponding to the *two real or topological dimensions* of  $k$ . Thus, from this point of view, it is natural to think of *ring structures* as corresponding to *holomorphic structures* — i.e., both ring and holomorphic structures are based on a certain complicated “*intertwining of the underlying two combinatorial dimensions*”. So far, in the theory of §1, §2, §3, and §4 of the present paper, the emphasis has been on “*holomorphic structures*”, i.e., of restricting ourselves to situations in which this “*complicated intertwining*” is *rigid*. By contrast, the various ideas introduced in Definition 5.6 relate to the issue of *disabling this rigidity* — i.e., of “*passing from one holomorphic to two underlying combinatorial/topological dimensions*” — an operation which, as was discussed in Remarks 1.9.4, 2.7.3, has the effect of leaving *only one* of the two combinatorial dimensions *rigid*. Put another way, this corresponds to the operation of “*passing from rings to monoids*”; this is the principal motivation for the term “*mono-analyticization*”.

The following result is elementary and well-known.

PROPOSITION 5.7 (Local Volumes). *Let  $k$  be either a mixed-characteristic nonarchimedean local field or a complex archimedean field.*

(i) *Suppose that  $k$  is nonarchimedean (cf. Definition 3.1, (i)). Write  $\mathfrak{m}_k \subseteq \mathcal{O}_k$  for the maximal ideal of  $\mathcal{O}_k$  and  $\mathbb{M}(k)$  for the set of compact open subsets of  $k$ . Then:*

(a) *There exists a unique map*

$$\mu_k : \mathbb{M}(k) \rightarrow \mathbb{R}_{>0}$$

*that satisfies the following properties: (1) additivity, i.e.,  $\mu_k(A \cup B) = \mu_k(A) + \mu_k(B)$ , for  $A, B \in \mathbb{M}(k)$  such that  $A \cap B =$*

$\emptyset$ ; (2)  $\boxplus$ -translation invariance, i.e.,  $\mu_k(A + x) = \mu_k(A)$ , for  $A \in \mathbb{M}(k)$ ,  $x \in k$ ; (3) normalization, i.e.,  $\mu_k(\mathcal{O}_k) = 1$ . We shall refer to  $\mu_k(-)$  as the volume on  $k$ . Also, we shall write  $\mu_k^{\log}(-) \stackrel{\text{def}}{=} \log(\mu_k(-))$  (where  $\log$  denotes the natural logarithm  $\mathbb{R}_{>0} \rightarrow \mathbb{R}$ ) and refer to  $\mu_k^{\log}(-)$  as the log-volume on  $k$ . If the residue field of  $k$  is of cardinality  $p^f$ , where  $p$  is a prime number and  $f$  a positive integer, then, for  $n \in \mathbb{Z}$ ,  $\mu_k^{\log}(\mathfrak{m}_k^n) = -f \cdot n \cdot \log(p)$ .

- (b) Let  $x \in k^\times$ ; set  $\dot{\mu}_k(x) \stackrel{\text{def}}{=} \mu_k(x \cdot \mathcal{O}_k)$ ,  $\dot{\mu}_k^{\log}(x) \stackrel{\text{def}}{=} \log(\dot{\mu}_k(x))$ . Then for  $A \in \mathbb{M}(k)$ , we have  $\mu_k^{\log}(x \cdot A) = \mu_k^{\log}(A) + \dot{\mu}_k^{\log}(x)$ ; in particular, if  $x \in \mathcal{O}_k^\times$ , then  $\mu_k^{\log}(x \cdot A) = \mu_k^{\log}(A)$ .
- (c) Write  $\log_k : \mathcal{O}_k^\times \rightarrow k$  for the ( $p$ -adic) logarithm on  $k$ . Let  $A \subseteq \mathcal{O}_k^\times$  be an open subset such that  $\log_k$  induces a bijection  $A \xrightarrow{\sim} \log_k(A)$ . Then  $\mu_k^{\log}(A) = \mu_k^{\log}(\log_k(A))$ .

(ii) Suppose that  $k$  is archimedean (cf. Definition 4.1, (i)); thus, we have a natural decomposition  $k^\times \cong \mathcal{O}_k^\times \times \mathbb{R}_{>0}$ , where  $\mathcal{O}_k^\times \cong \mathbb{S}^1$ , and we note that the projection  $k^\times \rightarrow \mathbb{R}_{>0}$  extends to a continuous map  $\text{pr}_{\mathbb{R}} : k \rightarrow \mathbb{R}$ . Write

$$\mathbb{M}(k) \text{ (respectively, } \check{\mathbb{M}}(k))$$

for the set of nonempty compact subsets  $A \subseteq k$  (respectively,  $A \subseteq k^\times$ ) such that  $A$  projects to a (compact) subset of  $\mathbb{R}$  (respectively,  $\mathcal{O}_k^\times$ ) which is the closure of its interior in  $\mathbb{R}$  (respectively,  $\mathcal{O}_k^\times$ ). Then:

- (a) The standard  $\mathbb{R}$ -valued absolute value on  $k$  determines a Riemannian metric (as well as a Kähler metric) on  $k$  that restricts to Riemannian metrics on  $\mathcal{O}_k^\times \xrightarrow{\sim} \mathcal{O}_k^\times \times \{1\} \hookrightarrow k^\times$  and  $\mathbb{R}_{>0} \xrightarrow{\sim} \{1\} \times \mathbb{R}_{>0} \hookrightarrow k^\times$ . Integrating these metrics over the projection of  $A \in \mathbb{M}(k)$  (respectively,  $A \in \check{\mathbb{M}}(k)$ ) to  $\mathbb{R}$  (respectively,  $\mathcal{O}_k^\times$ ) (i.e., “computing the length of  $A$  relative to these metrics”) yields a map

$$\mu_k : \mathbb{M}(k) \rightarrow \mathbb{R}_{>0} \text{ (respectively, } \check{\mu}_k : \check{\mathbb{M}}(k) \rightarrow \mathbb{R}_{>0})$$

that satisfies the following properties: (1) additivity, i.e.,  $\mu_k(A \cup B) = \mu_k(A) + \mu_k(B)$  (respectively,  $\check{\mu}_k(A \cup B) = \check{\mu}_k(A) +$



$\check{\mu}_k(B)$ ), for  $A, B \in \mathbb{M}(k)$  (respectively,  $A, B \in \check{\mathbb{M}}(k)$ ) whose projections to  $\mathbb{R}$  (respectively,  $\mathcal{O}_k^\times$ ) are disjoint; (2) normalization, i.e.,  $\mu_k(\mathcal{O}_k) = 1$  (respectively,  $\check{\mu}_k(\mathcal{O}_k^\times) = 2\pi$ ). We shall refer to  $\mu_k(-)$  (respectively,  $\check{\mu}_k(-)$ ) as the radial volume (respectively, angular volume) on  $k$ . Also, we shall write  $\mu_k^{\log}(-) \stackrel{\text{def}}{=} \log(\mu_k(-))$  (respectively,  $\check{\mu}_k^{\log}(-) \stackrel{\text{def}}{=} \log(\check{\mu}_k(-))$ ) and refer to  $\mu_k^{\log}(-)$  (respectively,  $\check{\mu}_k^{\log}(-)$ ) as the radial log-volume (respectively, angular log-volume) on  $k$ .

- (b) Let  $x \in k^\times$ ; set  $\dot{\mu}_k(x) \stackrel{\text{def}}{=} \mu_k(x \cdot \mathcal{O}_k)$ ,  $\dot{\mu}_k^{\log}(x) \stackrel{\text{def}}{=} \log(\dot{\mu}_k(x))$ . Then for  $A \in \mathbb{M}(k)$  (respectively,  $A \in \check{\mathbb{M}}(k)$ ), we have  $\mu_k^{\log}(x \cdot A) = \mu_k^{\log}(A) + \dot{\mu}_k^{\log}(x)$  (respectively,  $\check{\mu}_k^{\log}(x \cdot A) = \check{\mu}_k^{\log}(A)$ ); in particular, if  $x \in \mathcal{O}_k^\times$ , then  $\mu_k^{\log}(x \cdot A) = \mu_k^{\log}(A)$ .
- (c) Write  $\exp_k : k \rightarrow k^\times$  for the exponential map on  $k$ . Let  $A \in \mathbb{M}(k)$  be such that  $\exp_k(A) \subseteq \mathcal{O}_k^\times$ , and, moreover, the maps  $\text{pr}_{\mathbb{R}}$  and  $\exp_k$  induce bijections  $A \xrightarrow{\sim} \text{pr}_{\mathbb{R}}(A)$ ,  $A \xrightarrow{\sim} \exp_k(A)$ . Then  $\mu_k^{\log}(A) = \check{\mu}_k^{\log}(\exp_k(A))$ .

**PROOF.** First, we consider assertion (i). Part (a) follows immediately from well-known properties of the *Haar measure* on the *locally compact* (additive) *group*  $k$ . Part (b) follows immediately from the *uniqueness* portion of part (a). To verify part (c) for arbitrary  $A$ , it suffices (by the *additivity* property of  $\mu_k(-)$ ) to verify part (c) for  $A$  of the form  $x + \mathfrak{m}_k^n$  for  $n$  a sufficiently large positive integer,  $x \in \mathcal{O}_k^\times$ . But then  $\log_k$  determines a bijection  $x + \mathfrak{m}_k^n \xrightarrow{\sim} \log_k(x) + \mathfrak{m}_k^n$ , so the equality  $\mu_k^{\log}(A) = \mu_k^{\log}(\log_k(A))$  follows from the  $\boxplus$ -*translation invariance* of  $\mu_k^{\log}(-)$ . This completes the proof of assertion (i). Assertion (ii) follows immediately from well-known properties of the geometry of the complex plane.  $\square$

**REMARK 5.7.1.** The “*log-compatibility*” (i.e., part (c)) of Proposition 5.7, (i), (ii), may be regarded as a sort of “*integrated version*” of the fact that the derivative of the formal power series  $\log(1 + X) = X + \dots$  at  $X = 0$  is equal to 1. Moreover, the *opposite directions* of the “arrows involved” (i.e., logarithm versus exponential) in the nonarchimedean and archimedean cases is reminiscent of the discussion of Remark 4.5.2.

PROPOSITION 5.8 (Mono-analytic Reconstruction of Log-shells).

(i) Let  $G_k$  be the absolute Galois group of an MLF  $k$ . Then there exists a functorial (i.e., relative to  $\mathbb{TG}^+$ ) “group-theoretic” algorithm for constructing the images of the embeddings  $\mathcal{O}_k^\times \hookrightarrow G_k^{\text{ab}}, k^\times \hookrightarrow G_k^{\text{ab}}$  of local class field theory (cf. [Mzk9], Proposition 1.2.1, (iii), (iv)). Here, the asserted “functoriality” is contravariant and induced by the *Verlagerung*, or transfer, map on abelianizations. In particular, we obtain a functorial “group-theoretic” algorithm for reconstructing the residue characteristic  $p$  (cf. [Mzk9], Proposition 1.2.1, (i)), the invariant  $p^*$  (i.e.,  $p$  if  $p$  is odd;  $p^2$  if  $p$  is even — cf. Definition 5.4, (iii)), the cardinality  $p^f$  of the residue field of  $k$  (i.e., by adding 1 to the cardinality of the prime-to- $p$  torsion of  $k^\times$ ), the absolute degree  $[k : \mathbb{Q}_p]$  (i.e., as the dimension of  $\mathcal{O}_k^\times \otimes \mathbb{Q}_p$  over  $\mathbb{Q}_p$ ), the absolute ramification index  $e = [k : \mathbb{Q}_p]/f$ , and the order  $p^m$  of the subgroup of  $p$ -th power roots of unity of  $k^\times$ .

(ii) The algorithms of (i) yield a functorial (i.e., relative to  $\mathbb{TG}^+$ ) “group-theoretic” algorithm “ $\text{Ob}(\mathbb{TG}^+) \ni G \mapsto \vec{\Gamma}_{\text{non}}^\times(G)$ ” for constructing from  $G$  the  $\vec{\Gamma}_{\text{non}}^\times$ -diagram in  $\mathcal{C}_{\mathbb{TS}\boxplus}^{\text{MLF}^+}$  (cf. §0)

$$\begin{array}{ccc} \mathcal{O}_k^\times(G) & \hookrightarrow & \bar{k}^\times(G) \\ \downarrow & & \downarrow \\ k^\sim(G) & \hookrightarrow & (\bar{k}^\times)^{\text{pf}}(G) \end{array}$$

determined by the diagram of Definition 5.4, (iii), hence also the log-shell  $\mathcal{I}(G) \subseteq k^\sim(G)$  of  $\vec{\Gamma}_{\text{non}}^\times(G)$ .

(iii) The algorithms of (i) yield a functorial (i.e., relative to  $\mathbb{TG}^+$ ) “group-theoretic” algorithm “ $\text{Ob}(\mathbb{TG}^+) \ni G \mapsto \mathbb{R}_{\text{non}}(G)$ ” for constructing from  $G$  the topological group (which is isomorphic to  $\mathbb{R}$ )

$$\mathbb{R}_{\text{non}}(G) \stackrel{\text{def}}{=} (\bar{k}^\times(G)/\mathcal{O}_k^\times(G))^\wedge$$

— where “ $\wedge$ ” stands for the completion with respect to the order structure determined by the nonnegative elements, i.e., the image of  $\mathcal{O}_k^\times(G)/\mathcal{O}_k^\times(G)$  — equipped with a distinguished element, namely, the “Frobenius element”  $\mathbb{F}(G) \in \mathbb{R}_{\text{non}}(G)$  (cf. [Mzk9], Proposition 1.2.1, (iv)), which we think of as corresponding to the element  $f_G \cdot \log(p_G) \in \mathbb{R}$ , where  $p_G, f_G$  are the

invariants “p”, “f” of (i). Finally, these algorithms also yield a functorial, “group-theoretic” algorithm for constructing the log-volume map

$$\mu^{\log}(G) : \mathbb{M}(k^\sim(G)^G) \rightarrow \mathbb{R}_{\text{non}}(G)$$

— where “ $\mathbb{M}(-)$ ” is as in Proposition 5.7, (i); the superscript “ $G$ ” denotes the submodule of  $G$ -invariants; if we write  $m_G, e_G, p_G^*$  for the invariants “ $m$ ”, “ $e$ ”, “ $p^*$ ” of (i), then one may think of  $\mu^{\log}(G)$  as being normalized via the formula

$$\mu^{\log}(G)(\mathcal{I}(G)) = \{-1 - m_G/f_G + e_G \cdot \log(p_G^*)/\log(p_G)\} \cdot \mathbb{F}(G)$$

— determined by composing the map  $\mu_{k^\sim(G)^G}^{\log}$  of Proposition 5.7, (i), (a), with the isomorphism  $\mathbb{R} \xrightarrow{\sim} \mathbb{R}_{\text{non}}(G)$  given by  $f_G \cdot \log(p_G) \mapsto \mathbb{F}(G)$ . That is to say, “ $\mu^{\log}(G)$ ” and “ $\mathbb{M}(k^\sim(G)^G)$ ” are well-defined despite the fact one does not have an algorithm for reconstructing the field structure on  $k^\sim(G)^G$  (i.e., unlike the situation discussed in Proposition 5.7, (i)).

(iv) Let  $G = (C, \vec{C}) \in \text{Ob}(\text{TMM}^+)$ ; write  $C^\sim \rightarrow C^\times$  for the (pointed) universal covering of  $C^\times$  (cf. the definition of “ $k^\sim \rightarrow k^\times$ ” in Definition 4.1, (i)); thus, we regard  $C^\sim$  as a topological group (isomorphic to  $\mathbb{R}$ ). Then the evident isomorphism  $\mathfrak{L}ie^\pm(C^\sim) \cong \mathfrak{L}ie^\pm(C^\times)$  allows one to regard  $k^\sim(G) \stackrel{\text{def}}{=} C^\sim \times C^\sim, k^\times(G) \stackrel{\text{def}}{=} C^\times \times C^\sim$  as objects of  $\text{TB}\boxplus$ . Write  $\text{Seg}(G)$  for the equivalence classes of compact line segments on  $C^\sim$  (i.e., compact subsets which are either equal to the closure of a connected open set or are of cardinality one), relative to the equivalence relation determined by translation on  $C^\sim$ . Then forming the union of two compact line segments whose intersection is of cardinality one determines a monoid structure on  $\text{Seg}(G)$  with respect to which  $\text{Seg}(G) \xrightarrow{\sim} \mathbb{R}_{\geq 0}$ . In particular, this monoid structure determines a structure of topological monoid on  $\text{Seg}(G)$ .

(v) The constructions of (iv) yield a functorial (i.e., relative to  $\text{TMM}^+$ ) algorithm “ $\text{Ob}(\text{TMM}^+) \ni G \mapsto \vec{\Gamma}_{\text{arc}}^\times(G)$ ” for constructing from  $G$  the  $\vec{\Gamma}_{\text{arc}}^\times$ -diagram in  $C_{\text{TB}\boxplus}^{\text{hol}^+}$  (cf. §0)

$$k^\sim(G) = C^\sim \times C^\sim \quad \twoheadrightarrow \quad k^\times(G) = C^\times \times C^\sim$$

determined by the diagram of Definition 5.4, (v), hence also the log-shell

$$\mathcal{I}(G) \stackrel{\text{def}}{=} \{(a \cdot x, b \cdot x) \mid x \in \mathcal{I}_{C^\sim}; a, b \in \mathbb{R}; a^2 + b^2 = 1\} \subseteq k^\sim(G)$$

— where we write  $\mathcal{I}_{C^\sim} \subseteq C^\sim$  for the unique compact line segment on  $C^\sim$  that is invariant with respect to the action of  $\pm 1$  and, moreover, maps bijectively, except for its endpoints, to  $C^\times$  — of  $\bar{\Gamma}_{\text{arc}}^\times(G)$ .

(vi) The constructions of (iv) yield a functorial (i.e., relative to  $\text{TMM}^\Gamma$ ) algorithm “ $\text{Ob}(\text{TMM}^\Gamma) \ni G \mapsto \mathbb{R}_{\text{arc}}(G)$ ” for constructing from  $G$  the topological group (which is isomorphic to  $\mathbb{R}$ )

$$\mathbb{R}_{\text{arc}}(G) \stackrel{\text{def}}{=} \text{Seg}(G)^{\text{gp}}$$

equipped with a distinguished element, namely, the “Frobenius element”  $\mathbb{F}(G) \in \text{Seg}(G) \subseteq \mathbb{R}_{\text{arc}}(G)$  determined by a compact line segment that maps bijectively, except for its endpoints, to  $C^\times$ ; we shall think of  $\mathbb{F}(G)$  as corresponding to  $2\pi \in \mathbb{R}$ . Finally, these algorithms also yield a functorial, algorithm for constructing the radial and angular log-volume maps

$$\mu^{\log}(G) : \mathbb{M}(k^\sim(G)) \rightarrow \mathbb{R}_{\text{arc}}(G); \quad \check{\mu}^{\log}(G) : \check{\mathbb{M}}(k^\sim(G)) \rightarrow \mathbb{R}_{\text{arc}}(G)$$

— where “ $\mathbb{M}(-)$ ”, “ $\check{\mathbb{M}}(-)$ ” are as in Proposition 5.7, (ii); if, in the style of the definition of  $\mathcal{I}(G)$  in (v), we write  $\partial\mathcal{I}_{C^\sim}$  for the boundary (i.e., the two endpoints) of  $\mathcal{I}_{C^\sim}$  and

$$\mathcal{O}_{k^\sim}^\times(G) \stackrel{\text{def}}{=} \{(a \cdot x, b \cdot x) \mid x \in \partial\mathcal{I}_{C^\sim}; a, b \in \mathbb{R}; a^2 + b^2 = \pi^{-2}\} \subseteq k^\sim(G)$$

(so one has a natural bijection  $\mathbb{R}_{>0} \times \mathcal{O}_{k^\sim}^\times(G) \xrightarrow{\sim} k^\sim(G) \setminus \{0\}$ ), then one may think of  $\mu^{\log}(G)$ ,  $\check{\mu}^{\log}(G)$  as being normalized via the formulas

$$\mu^{\log}(G)(\mathcal{I}(G)) = \check{\mu}^{\log}(G)(\mathcal{O}_{k^\sim}^\times(G)) - \log(2) \cdot \mathbb{F}(G)/2\pi = \log(\pi) \cdot \mathbb{F}(G)/2\pi$$

— determined by composing the maps  $\mu_{k^\sim(G)}^{\log}$ ,  $\check{\mu}_{k^\sim(G)}^{\log}$  of Proposition 5.7, (ii), (a), with the isomorphism  $\mathbb{R} \xrightarrow{\sim} \mathbb{R}_{\text{arc}}(G)$  given by  $2\pi \mapsto \mathbb{F}(G)$ . That is to say, “ $\mu^{\log}(G)$ ”, “ $\check{\mu}^{\log}(G)$ ”, “ $\mathbb{M}(k^\sim(G))$ ”, and “ $\check{\mathbb{M}}(k^\sim(G))$ ” are well-defined despite the fact one does not have an algorithm for reconstructing the field structure on  $k^\sim(G)$  (i.e., unlike the situation discussed in Proposition 5.7, (ii)).

(vii) Let  $Z$  be an elliptically admissible hyperbolic orbicurve over an algebraic closure of  $\mathbb{Q}$ ;  $\mathcal{V}^{\mathfrak{X}} \in \text{Ob}(\mathfrak{Th}^{\mathfrak{X}}[Z])$  (cf. the notation of Definition 5.1, (iv); Definition 5.4, (i));  $\mathcal{W}^\Gamma \in \text{Ob}(\mathfrak{Th}^\Gamma[Z])$  the mono-analyticization

of  $\mathcal{V}^{\times}$  (cf. the notation of Definition 5.6, (ii));  $w \in W^{\text{non}}$  (respectively,  $w \in W^{\text{arc}}$ ). Write

$$\mathfrak{An}^{\dagger}[\mathcal{N}_w^{\dagger\boxplus}]$$

for the category whose objects consist of an object of  $\mathfrak{H}^{\dagger}[Z]$ , together with the object of  $\text{Orb}(\mathcal{C}_{\mathbb{T}\mathbb{S}\boxplus}^{\text{MLF}^{\dagger}}[\vec{\Gamma}_{\text{non}}^{\times}])$  (respectively,  $\text{Orb}(\mathcal{C}_{\mathbb{T}\mathbb{B}\boxplus}^{\text{hol}^{\dagger}}[\vec{\Gamma}_{\text{arc}}^{\times}])$ ) given by applying the algorithm “ $G \mapsto \vec{\Gamma}_{\text{non}}^{\times}(G)$ ” of (ii) (respectively, “ $G \mapsto \vec{\Gamma}_{\text{arc}}^{\times}(G)$ ” of (v)) to the object of  $\text{Orb}(\mathbb{T}\mathbb{G}^{\dagger})$  (respectively,  $\text{Orb}(\mathbb{T}\mathbb{M}^{\dagger})$ ) obtained by projecting (at  $w$  — cf. Definition 5.6, (ii)) the given object of  $\mathfrak{H}^{\dagger}[Z]$ , and whose morphisms are the morphisms induced by  $\mathfrak{H}^{\dagger}[Z]$ . Thus we obtain a natural equivalence of categories

$$\mathfrak{H}^{\dagger}[Z] \xrightarrow{\sim} \mathfrak{An}^{\dagger}[\mathcal{N}_w^{\dagger\boxplus}]$$

together with a “forgetful functor”

$$\psi_{w,\nu}^{\mathfrak{An}^{\dagger\boxplus}} : \mathfrak{An}^{\dagger}[\mathcal{N}_w^{\dagger\boxplus}] \rightarrow \mathcal{N}_w^{\dagger\boxplus}$$

(cf. Definition 5.6, (iii), (iv)) for each vertex  $\nu$  of  $\vec{\Gamma}_w^{\times} \stackrel{\text{def}}{=} \vec{\Gamma}_{\text{non}}^{\times}$  (respectively,  $\vec{\Gamma}_w^{\times} \stackrel{\text{def}}{=} \vec{\Gamma}_{\text{arc}}^{\times}$ ), and a natural transformation

$$\iota_{w,\epsilon}^{\mathfrak{An}^{\dagger\boxplus}} : \psi_{w,\nu_1}^{\mathfrak{An}^{\dagger\boxplus}} \rightarrow \psi_{w,\nu_2}^{\mathfrak{An}^{\dagger\boxplus}}$$

for each edge  $\epsilon$  of  $\vec{\Gamma}_w^{\times}$  running from a vertex  $\nu_1$  to a vertex  $\nu_2$ . Finally, we shall omit the symbol “ $\boxplus$ ” from the above notation to denote the result of composing the functors and natural transformations discussed above with the natural functor  $\mathcal{N}_w^{\dagger\boxplus} \rightarrow \mathcal{N}_w^{\dagger}$ ; also, we shall replace the symbol “ $\mathfrak{An}^{\dagger}$ ” by the symbol “ $\dagger$ ” in the superscripts of the above notation to denote the result of restricting the functors and natural transformations discussed above to  $\mathfrak{H}^{\dagger}[Z]$ .

PROOF. The various assertions of Proposition 5.8 are immediate from the definitions and the references quoted in these definitions.  $\square$

REMARK 5.8.1.

(i) One way to summarize the *archimedean* portion of Proposition 5.8 is as follows: Suppose that one starts with the (Aut-)holomorphic monoid given by an isomorph of  $\mathcal{O}_{\mathbb{C}}^{\succ}$  (i.e., where one thinks of the (Aut-)holomorphic

structure on  $\mathcal{O}_{\mathbb{C}}^{\triangleright}$  as consisting of a(n) (Aut-)holomorphic structure on  $(\mathcal{O}_{\mathbb{C}}^{\triangleright})^{\text{gp}} = \mathbb{C}^{\times}$  arising as the  $\mathcal{O}_{\mathcal{A}_{\mathbb{X}}}^{\triangleright}$  for some  $\mathbb{X} \in \text{Ob}(\mathbb{E}\mathbb{A})$ . The operation of *mono-analyticization* consists of “forgetting the rigidification of the (Aut-)holomorphic structure furnished by  $\mathbb{X}$ ” (cf. Remark 2.7.3). Thus, applying the operation of mono-analyticization to an isomorph of  $\mathcal{O}_{\mathbb{C}}^{\triangleright}$  yields the object of  $\text{TM}^{\Gamma}$  consisting of an isomorph of the *topological monoid*  $\mathcal{O}_{\mathbb{C}}^{\triangleright}$  equipped with the submonoid corresponding to  $\mathcal{O}_{\mathbb{C}}^{\triangleright} \cap \mathbb{R}_{>0}$ , which is *non-rigid*, in the sense that it is subject to *dilations* (cf. Remark 2.7.3). On the other hand:

From the point of view of the theory of *log-shells*, one wishes to perform the operation of *mono-analyticization* — i.e., of “forgetting the (Aut-)holomorphic structure” — in such a way that one *does not obliterate the metric rigidity* (i.e., the “applicability” of the theory of Proposition 5.7) of the log-shells involved.

This is precisely what is achieved by the use of the category  $\text{TB}\boxplus$  — cf., especially, the construction of the *natural functor*  $\mathcal{C}_{\text{TH}\boxplus}^{\text{hol}} \rightarrow \mathcal{C}_{\text{TB}\boxplus}^{\text{hol}\Gamma}$  in Definition 5.6, (iv); the constructions of Proposition 5.8, (iv), (v), (vi). That is to say, the “*metric rigidity*” of log-shells is preserved even after mono-analyticization by thinking of the “metric rigidity” of the *original* (Aut-)holomorphic  $\mathcal{O}_{\mathbb{C}}^{\triangleright}$  as being constituted by

“the metric rigidity of  $\mathbb{S}^1 \cong \mathcal{O}_{\mathbb{C}}^{\times}$ , together with the rotation automorphisms of  $\mathfrak{L}\mathfrak{ie}(\mathbb{C}^{\times})$  of order 4” (cf. Definition 5.6, (iv)).

That is to say, this approach to describing “(Aut-)holomorphic metric rigidity” has the *advantage* of being “*immune to mono-analyticization*” — cf. the construction of  $k^{\sim}(G)$  as “ $C^{\sim} \times C^{\sim}$ ” in Proposition 5.8, (iv). On the other hand, it has the *disadvantage* that it is *not compatible* (as one might expect from any sort of mono-analyticization operation!) with preserving the *complex archimedean field structure* of “ $k^{\sim}$ ”. That is to say, the two factors of  $C^{\sim}$  appearing in the product “ $C^{\sim} \times C^{\sim}$ ” — which should correspond to the *imaginary* and *real* portions of such a complex archimedean field structure — may only be related to one another *up to a  $\{\pm 1\}$  indeterminacy*, an indeterminacy that has the effect of obliterating the ring/field structure involved.

(ii) It is interesting to note that the discussion of the *archimedean* situation of (i) is strongly reminiscent of the *nonarchimedean* portion of Proposition 5.8, which allows one to construct *metrically rigid log-shells* which are *immune to mono-analyticization*, but only at the expense of *sacrificing the ring/field structures involved*.

DEFINITION 5.9.

(i) By pulling back the various *functorial algorithms* of Proposition 5.8 defined on  $\mathrm{TG}^\dagger$ ,  $\mathrm{TM}^\dagger$  via the *mono-analyticization functors*  $\mathrm{TG}^{\mathrm{sB}} \rightarrow \mathrm{TG}^\dagger$ ,  $\mathrm{EA} \rightarrow \mathrm{TM}^\dagger$ , we obtain *functorial algorithms* defined on  $\mathrm{TG}^{\mathrm{sB}}$ ,  $\mathrm{EA}$ . In particular, if, in the notation of Definition 5.1, (iii) (respectively, Definition 5.1, (iv); Definition 5.6, (ii)),  $\mathcal{V}^\circledast$  (respectively,  $\mathcal{V}^{\mathbf{x}}$ ;  $\mathcal{W}^\dagger$ ) is a *global* (respectively, *panalocal*; *mono-analytic*) *Galois-theater*, then for each  $v \in V \stackrel{\mathrm{def}}{=} \overline{V}/\mathrm{Aut}(\Pi)$  (respectively,  $v \in V$ ;  $v \in W$ ), we obtain — i.e., by applying the *functorial algorithms* “ $\mathbb{R}_{\mathrm{non}}(-)$ ”, “ $\mathbb{R}_{\mathrm{arc}}(-)$ ” of Proposition 5.8, (iii), (vi) — (*orbi*-)topological groups (isomorphic to  $\mathbb{R}$ )

$$\mathbb{R}_v$$

equipped with *distinguished Frobenius elements*  $\mathbb{F}_v \in \mathbb{R}_v$ . Moreover, if we write  $\circledast_V$  for the unique global element of  $V^\circledast \stackrel{\mathrm{def}}{=} \overline{V}^\circledast/\mathrm{Aut}(\Pi)$  (respectively,  $V^\circledast$ ;  $W^\circledast$ ), then we obtain a(n) (*orbi*-)topological group (isomorphic to  $\mathbb{R}$ )

$$\mathbb{R}_{\circledast_V} \subseteq \prod_v \mathbb{R}_v$$

— where the product ranges over  $v \in V$  (respectively,  $v \in V$ ;  $v \in W$ ) — obtained as the “*graph*” of the correspondences between the  $\mathbb{R}_v$ ’s that relate the  $\mathbb{F}_v/(f_v \cdot \log(p_v))$  (where “ $f_v$ ”, “ $p_v$ ” are the invariants “ $f_G$ ”, “ $p_G$ ” of Proposition 5.8, (iii)) for *nonarchimedean*  $v$  to the  $\mathbb{F}_v/2\pi$  for *archimedean*  $v$ . Thus,  $\mathbb{R}_{\circledast_V}$  is equipped with a *distinguished element*  $\mathbb{F}_{\circledast_V} \in \mathbb{R}_{\circledast_V}$  (which we think of as corresponding to  $1 \in \mathbb{R}$ ), and we have *natural isomorphisms of (*orbi*-)topological groups*  $\mathbb{R}_{\circledast_V} \xrightarrow{\sim} \mathbb{R}_v$  that map  $\mathbb{F}_{\circledast_V} \mapsto \mathbb{F}_v/(f_v \cdot \log(p_v))$  for *nonarchimedean*  $v$  and  $\mathbb{F}_{\circledast_V} \mapsto \mathbb{F}_v/2\pi$  for *archimedean*  $v$  (where we note that *division* of elements of the *abstract topological group*  $\mathbb{R}_v$  by a positive real number is *well-defined*).

(ii) In the notation of Definition 5.1, (v) (respectively, Definition 5.1, (vi)), let  $\mathcal{M}^\circledast$  (respectively,  $\mathcal{M}^{\mathbf{x}}$ ) be a *global* (respectively, *panalocal*)  $\mathbb{T}$ -pair, for  $\mathbb{T} \in \{\mathrm{TF}, \mathrm{TM}\}$ . In the non-resp’d case, write  $V^\circledast \stackrel{\mathrm{def}}{=} \overline{V}^\circledast/\mathrm{Aut}(\Pi)$ .

Then the various *log-volumes* defined in Proposition 5.7, (i), (ii), determine maps

$$\{\mu_v^{\log} : \mathbb{M}(M_v^{\Pi_v}) \rightarrow \mathbb{R}_v\}_{v \in V}; \quad \{\check{\mu}_v^{\log} : \check{\mathbb{M}}(M_v^{\Pi_v}) \rightarrow \mathbb{R}_v\}_{v \in V^{\text{arc}}}$$

— where we write  $\mathbb{M}(M_v^{\Pi_v})$ , (when  $v \in V^{\text{arc}}$ )  $\check{\mathbb{M}}(M_v^{\Pi_v} = M_v)$  for the set of subsets determined (via the *reference isomorphisms* “ $\psi_{\bar{v}}$ ” of Definition 5.1, (v); the “*forgetful functors*” of Corollary 5.2, (iv), (vii)) by intersecting with  $M_{\mathbb{T}}(\Pi, \bar{v})^{\Pi_{\bar{v}}} \subseteq \bar{k}_{\text{NF}}(\Pi, \bar{v})^{\Pi_{\bar{v}}}$  the corresponding collection of subsets of  $\mathbb{M}(\bar{k}_{\text{NF}}(\Pi, \bar{v})^{\Pi_{\bar{v}}})$ , (when  $v \in V^{\text{arc}}$ )  $\check{\mathbb{M}}(\bar{k}_{\text{NF}}^{\times}(\Pi, \bar{v})^{\Pi_{\bar{v}}})$ .

(iii) In the non-resp’d (i.e., *global*) case of (ii), suppose further that  $\mathbb{T} = \mathbb{T}\mathbb{F}$ . Then for any  $\boxplus$ -line bundle  $\mathcal{L}^{\boxplus}$  on  $\mathcal{M}^{\odot}$ , one verifies immediately that there exist morphisms of  $\boxplus$ -line bundles on  $\mathcal{M}^{\odot}$

$$\zeta : \mathcal{L}_1^{\boxplus} \rightarrow \mathcal{L}^{\boxplus}; \quad \zeta_0 : \mathcal{L}_1^{\boxplus} \rightarrow \mathcal{L}_0^{\boxplus}$$

such that  $\mathcal{L}_0^{\boxplus}$  is isomorphic to the *trivial*  $\boxplus$ -line bundle. Thus, for each  $v \in V$ , we obtain *isomorphisms of  $M_v^{\Pi_v}$ -vector spaces*  $\zeta[v] : \mathcal{L}_1^{\boxplus}[v] \xrightarrow{\sim} \mathcal{L}^{\boxplus}[v]$ ,  $\zeta_0[v] : \mathcal{L}_1^{\boxplus}[v] \xrightarrow{\sim} \mathcal{L}_0^{\boxplus}[v]$ . Moreover, by applying these isomorphisms, we obtain subsets  $S_v \subseteq \mathcal{L}_0^{\boxplus}[v]$  for each  $v \in V$  as follows: If  $v \in V^{\text{non}}$ , then we take  $S_v$  to be the subset determined by the closure of the image (via the various  $\rho_{\bar{v}}$ , for  $\bar{v} \in \bar{V}$  lying over  $v$ ) of  $\mathcal{L}^{\boxplus}[\odot]$ . If  $v \in V^{\text{arc}}$ , then we take  $S_v$  to be the subset determined by the set of elements of  $\mathcal{L}^{\boxplus}[v]$  for which  $|\cdot|_{\mathcal{L}^{\boxplus}[v]} \leq 1$ . Now set

$$\mu_{\odot}^{\log}(\mathcal{L}^{\boxplus}) \stackrel{\text{def}}{=} \sum_{v \in V^{\text{arc}}} 2\mu_v^{\log}(S_v)^{\odot}/d_v^{\text{mod}} + \sum_{v \in V^{\text{non}}} \mu_v^{\log}(S_v)^{\odot}/d_v^{\text{mod}} \in \mathbb{R}_{\odot_V}$$

— where  $d_v^{\text{mod}}$  is as in Definition 5.1, (ii), for  $v \in V \cong \mathbb{V}(F^{\text{mod}})$ ; the superscript “ $\odot$ ” denotes the result of applying the *natural isomorphisms*  $\mathbb{R}_{\odot_V} \xrightarrow{\sim} \mathbb{R}_v$  of (i); we note that the sum is *finite*, since  $\mu_v^{\log}(S_v) = 0$  for all but finitely many  $v \in V$ . As is well-known (or easily verified!) from *elementary number theory* — i.e., the so-called “*product formula*”! — it follows immediately that (as the notation suggests) “ $\mu_{\odot}^{\log}(\mathcal{L}^{\boxplus})$ ” *depends only on the isomorphism class of  $\mathcal{L}^{\boxplus}$*  and, in particular, is *independent of the choice of  $\zeta, \zeta_0$* . Finally, by applying the *equivalences of categories* of Definition 5.3, (ii), (iii), it follows immediately that we may extend the  $\mathbb{R}_{\odot_V}$ -valued function (on isomorphism classes of  $\boxplus$ -line bundles on  $\mathcal{M}^{\odot}$ )

$$\mu_{\odot}^{\log}(-)$$



to a function that is also defined on isomorphism classes of  $\boxtimes$ -line bundles on  $\mathcal{M}^\circledast$ , for arbitrary  $\mathbb{T} \in \{\text{TF}, \text{TM}, \text{TLG}\}$ .

REMARK 5.9.1. Just as in Remark 5.3.1, one may define — in the *style* of Corollary 5.2 — a *category*  $\mathfrak{An}^\circledast[\mathfrak{H}_\mathbb{T}^\bullet, \mu]$ , where  $\bullet \in \{\circledast, \boxtimes\}$ , whose objects are data of the form

$$\mathcal{M}_\mathbb{T}^{\bullet\mu}(\Pi) \stackrel{\text{def}}{=} (\mathcal{M}_\mathbb{T}^\bullet(\Pi), \{(\mathbb{R}_v, \mu_v^{\log}(\Pi_v)(-))\}_{v \in V^{\text{non}}}, \{(\mathbb{R}_v, \mu_v^{\log}(\mathbb{X}_v)(-), \check{\mu}_v^{\log}(\mathbb{X}_v)(-))\}_{v \in V^{\text{arc}}})$$

— where the “ $(\Pi_v)$ ’s”, “ $(\mathbb{X}_v)$ ’s” preceding the “ $(-)$ ’s” are to be understood as denoting the log-volumes associated, as in Definition 5.9, (ii), to the various constituent data of  $\mathcal{M}_\mathbb{T}^\bullet(\Pi)$  — for  $\Pi \in \text{Ob}(\mathbb{EA}^\circledast)$ , and whose morphisms are the morphisms induced by morphisms of  $\mathbb{EA}^\circledast$ . In a similar vein, by combining the data that constitutes an object of  $\mathfrak{An}^{\boxtimes}[\mathfrak{H}_\mathbb{T}^{\boxtimes}]$  with the data

$$\{(\mathbb{R}_v, \mu_v^{\log}(\Pi_v)(-))\}_{v \in V}, \{(\mathbb{R}_v, \mu_v^{\log}(\mathbb{X}_v)(-), \check{\mu}_v^{\log}(\mathbb{X}_v)(-))\}_{v \in V^{\text{arc}}}$$

— where the “ $(\Pi_v)$ ’s”, “ $(\mathbb{X}_v)$ ’s” preceding the “ $(-)$ ’s” are to be understood as denoting the log-volumes associated, as in Definition 5.9, (ii), to the various constituent data of the original object of  $\mathfrak{An}^{\boxtimes}[\mathfrak{H}_\mathbb{T}^{\boxtimes}]$  — and considering the morphisms induced by morphisms of  $\mathfrak{H}^{\boxtimes}$ , we obtain a category  $\mathfrak{An}^{\boxtimes}[\mathfrak{H}_\mathbb{T}^{\boxtimes}, \mu]$ . Finally, by combining the constructions of Definitions 5.3, 5.9; Remark 5.3.1, we obtain a *category*  $\mathfrak{An}^\circledast[\mathfrak{H}_\mathbb{T}^\circledast, |\square|, \mu]$  whose objects are data of the form

$$\mathcal{M}_\mathbb{T}^{\circledast|\square|\mu}(\Pi) \stackrel{\text{def}}{=} (\mathcal{M}_\mathbb{T}^{\circledast|\square|}(\Pi), \mathbb{R}_{\circledast V}, \{\mu_v^{\log}(\Pi)(-)^{\circledast}\}_{v \in V^{\text{non}}}, \{\mu_v^{\log}(\Pi)(-)^{\circledast}, \check{\mu}_v^{\log}(\Pi)(-)^{\circledast}\}_{v \in V^{\text{arc}}}, \mu_{\circledast}^{\log}(\Pi)(-))$$

— where the “ $(\Pi)$ ’s” preceding the “ $(-)$ ’s” are to be understood as denoting the log-volumes associated, as in Definition 5.9, (ii), (iii), to the various constituent data of  $\mathcal{M}_\mathbb{T}^{\circledast|\square|}(\Pi)$  — for  $\Pi \in \text{Ob}(\mathbb{EA}^\circledast)$ , and whose morphisms are the morphisms induced by morphisms of  $\mathbb{EA}^\circledast$ . Then, just as in Corollary 5.2, Remark 5.3.1, one obtains sequences of *natural functors*

$$\begin{aligned} \mathbb{EA}^\circledast &\rightarrow \mathfrak{An}^\circledast[\mathfrak{H}_\mathbb{T}^\bullet, \mu] \rightarrow \mathfrak{An}^\circledast[\mathfrak{H}_\mathbb{T}^\bullet] \rightarrow \mathfrak{H}_\mathbb{T}^\bullet \rightarrow \mathfrak{H}^\bullet \\ \mathfrak{H}^{\boxtimes} &\rightarrow \mathfrak{An}^{\boxtimes}[\mathfrak{H}_\mathbb{T}^{\boxtimes}, \mu] \rightarrow \mathfrak{An}^{\boxtimes}[\mathfrak{H}_\mathbb{T}^{\boxtimes}] \rightarrow \mathfrak{H}_\mathbb{T}^{\boxtimes} \rightarrow \mathfrak{H}^{\boxtimes} \\ \mathbb{EA}^\circledast &\rightarrow \mathfrak{An}^\circledast[\mathfrak{H}_\mathbb{T}^\circledast, |\square|, \mu] \rightarrow \mathfrak{An}^\circledast[\mathfrak{H}_\mathbb{T}^\circledast, |\square|] \rightarrow \mathfrak{H}_\mathbb{T}^\circledast \rightarrow \mathbb{EA}^\circledast \end{aligned}$$

— where the first arrows are the functors arising from the definitions of the categories “ $\mathfrak{An}^\circ[-, \mu]$ ”, “ $\mathfrak{An}^\times[-, \mu]$ ”; with the *exception* of the second to last arrow of the first line of the above display in the case where  $\bullet = \times$ , every arrow of the above display is an *equivalences of categories* (cf. Corollary 5.2, (i), (iv), (v), (vii); Remark 5.3.1).

REMARK 5.9.2. The significance of measuring (log-)volumes in units that belong to the copies of  $\mathbb{R}$  determined by “ $\mathbb{R}_{\text{non}}(-)$ ”, “ $\mathbb{R}_{\text{arc}}(-)$ ” lies in the fact that such measurements may compared on both sides of the “log-wall”, as well as in a fashion compatible with the operation of *mono-analyticization* (cf. the discussion of Remark 3.7.7; Corollary 5.10, (ii), (iv), below).

We are now ready to state the *main result* of the present §5 (and, indeed, of the present paper!).

COROLLARY 5.10 (Fundamental Properties of Log-shells). *In the notation of Corollary 5.5; Proposition 5.8, (vii), write*

$$\mathcal{E}^+ \stackrel{\text{def}}{=} \mathfrak{Th}^+[Z]; \quad \mathfrak{An}^+[\mathcal{N}^{\dagger\boxplus}] \stackrel{\text{def}}{=} \prod_{v \in \mathbb{V}(F^{\text{mod}})} \mathfrak{An}^+[\mathcal{N}_v^{\dagger\boxplus}]$$

— where the product is a fibered product of categories over  $\mathcal{E}^+ = \mathfrak{Th}^+[Z]$ . Consider the diagram of categories  $\mathcal{D}^+$

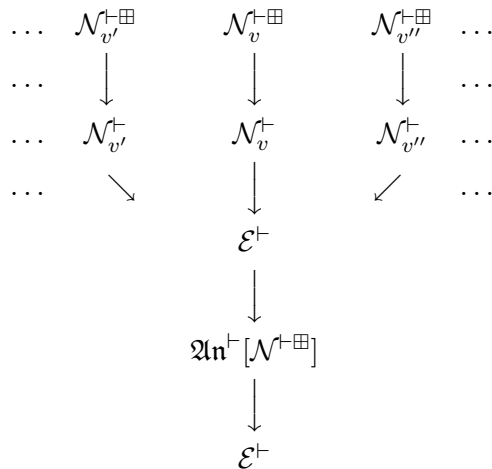

— where we regard the rows of  $\mathcal{D}^\dagger$  as being indexed by the integers 3, 4, 5, 6, 7 (relative to which we shall use the notation “ $\mathcal{D}_{\leq n}^\dagger$ ” — cf. Corollary 5.5); the arrows of  $\mathcal{D}_{\leq 5}^\dagger$  are those discussed in Definition 5.6, (iii), (iv); the arrows of the rows numbered 5, 6, 7 of  $\mathcal{D}^\dagger$  are the arrows determined by the equivalence of categories of Proposition 5.8, (vii). Note, moreover, that we have a natural mono-analyticization morphism (consisting of arrows between corresponding vertices belonging to rows indexed by the same integer!) of diagrams of categories

$$\mathcal{D}_{\geq 3}^\bullet \rightarrow \mathcal{D}^\dagger$$

(cf. Definition 5.4, (iv), (vi), as well as the discussion, involving pananalyticization and mono-analyticization functors, of Corollary 5.5, (vi); Definition 5.6, (ii), (iii), (iv)) — where the subscript “ $\geq 3$ ” refers to the portion involving the rows numbered 3, 4, 5, 6, 7, and we take the arrow  $\mathfrak{An}^\bullet[\mathcal{X}] \rightarrow \mathfrak{An}^\dagger[\mathcal{N}^{\square\dagger}]$  to be the arrow induced, via the equivalence of categories  $\kappa_{\mathfrak{An}^\bullet}$  of Corollary 5.5 and the equivalence of categories of Proposition 5.8, (vii), by the mono-analyticization functor  $\mathcal{E}^\bullet \rightarrow \mathcal{E}^\dagger$ ; write

$$\mathcal{D}^{\bullet\dagger}$$

for the diagram of categories obtained by gluing  $\mathcal{D}^\bullet$ ,  $\mathcal{D}^\dagger$  via this mono-analyticization morphism. We shall refer to the various isomorphisms between composites of functors inherent in the definition of the mono-analyticization morphism  $\mathcal{D}_{\geq 3}^\bullet \rightarrow \mathcal{D}^\dagger$  (e.g., the natural isomorphisms between the functors associated to the two length 2 paths  $\mathcal{N}_v^\square \rightarrow \mathcal{N}_v^{\square\dagger} \rightarrow \mathcal{N}_v^\dagger$ ,  $\mathcal{N}_v^\square \rightarrow \mathcal{N}_v \rightarrow \mathcal{N}_v^\dagger$ , where  $v \in \mathbb{V}(F^{\text{mod}})$ , in the third and fourth rows of  $\mathcal{D}^{\bullet\dagger}$ ) as mono-analyticization homotopies. We shall refer to the natural transformation “ $\iota_{v,\epsilon}^\square$ ” of Corollary 5.5, (iii), as a shell-homotopy (at  $v$ ) if  $\epsilon$  is a shell-arrow (cf. Definition 5.4, (iii), (v)); we shall refer to “ $\iota_{v,\epsilon}^\square$ ” as a **log**-homotopy (at  $v$ ) if the initial vertex of  $\epsilon$  is a post-log vertex. If  $v \in \mathbb{V}(F^{\text{mod}})^{\text{non}}$  (respectively,  $v \in \mathbb{V}(F^{\text{mod}})^{\text{arc}}$ ), then we shall refer to as a **•**-shell-container structure on an object  $S \in \text{Ob}(\mathcal{N}_v^\square)$  the datum of an object  $S' \in \text{Ob}(\mathcal{X})$  together with an isomorphism  $S \xrightarrow{\sim} \lambda_{v,\nu}^\square(S')$ , where  $\nu$  is the terminal (respectively, initial) vertex of the shell-arrow of  $\bar{\Gamma}_v^\times$ ; an object of  $\mathcal{N}_v^\square$  equipped with a **•**-shell-container structure will be referred to as a **•**-shell-container. Note that the shell-homotopies determine **•**-log-shells “ $\mathcal{I}$ ” (cf. Definition 5.4, (iii), (v)) inside the underlying object of  $\text{TS}\square$  (respectively,  $\text{TH}\square$ ) determined by each **•**-shell-container. If  $v \in \mathbb{V}(F^{\text{mod}})^{\text{non}}$

(respectively,  $v \in \mathbb{V}(F^{\text{mod}})^{\text{arc}}$ ), and  $S$  is an object of  $\mathcal{N}_v^{\boxplus}$  or  $\mathcal{N}_v^{\boxplus}$ , then we shall write  $S^{\text{Gal}}$  for the topological submodule of Galois-invariants of (respectively, the topological submodule constituted by) the underlying object of  $\mathbb{T}\mathbb{S}\boxplus$  (respectively,  $\mathbb{T}\mathbb{H}\boxplus$  or  $\mathbb{T}\mathbb{B}\boxplus$ ) determined by  $S$ .

(i) (Finite Log-volume) Let  $v \in \mathbb{V}(F^{\text{mod}})^{\text{non}}$  (respectively,  $v \in \mathbb{V}(F^{\text{mod}})^{\text{arc}}$ ). For each  $\bullet$ -shell-container  $S \in \text{Ob}(\mathcal{N}_v^{\boxplus})$ ,  $S^{\text{Gal}}$  is equipped with a well-defined log-volume (respectively, well-defined radial and angular log-volumes) (cf. Definition 5.9, (ii)) that depend(s) only on the  $\bullet$ -shell-container structure of  $S$ . Moreover, the  $\bullet$ -log-shell is contained in  $S^{\text{Gal}}$  and (relative to these log-volumes) is of finite log-volume (respectively, finite radial log-volume).

(ii) (Log-Frobenius Compatibility of Log-volumes) For  $v, S$  as in (i), the log-volume (respectively, radial log-volume), computed “at  $\Upsilon \in L$ ”, is compatible (cf. part (c) of Proposition 5.7, (i), (ii)), relative to the relevant **log**-homotopy, with the log-volume (respectively, angular log-volume), computed “at  $\Upsilon + 1 \in L$ ”.

(iii) (Panalocalization) The log-volumes of (i), as well as the construction of the  $\bullet$ -log-shells from the various shell-homotopies, are compatible with the panalocalization morphism  $\mathcal{D}^{\circlearrowleft} \rightarrow \mathcal{D}^{\boxtimes}$  of Corollary 5.5, (vi).

(iv) (Mono-analyticization) If  $v \in \mathbb{V}(F^{\text{mod}})^{\text{non}}$  (respectively,  $v \in \mathbb{V}(F^{\text{mod}})^{\text{arc}}$ ), then we shall refer to as a  $\bullet\vdash$ -shell-container structure on an object  $S \in \text{Ob}(\mathcal{N}_v^{\boxplus})$  the datum of an object  $S' \in \text{Ob}(\mathcal{X})$  together with an isomorphism from  $S$  to the image in  $\mathcal{N}_v^{\boxplus}$  of  $\lambda_{v,\nu}^{\boxplus}(S')$ , where  $\nu$  is the terminal (respectively, initial) vertex of the shell-arrow of  $\vec{\Gamma}_v^{\times}$ ; an object of  $\mathcal{N}_v^{\boxplus}$  equipped with a  $\bullet\vdash$ -shell-container structure will be referred to as a  $\bullet\vdash$ -shell-container. Note that the shell-homotopies determine  $\bullet\vdash$ -log-shells “ $\mathcal{I}$ ” (cf. Definition 5.4, (iii), (v)) inside each  $\bullet\vdash$ -shell-container, as well as a well-defined log-volume (respectively, well-defined radial and angular log-volumes) on the Gal-superscripted module associated to a  $\bullet\vdash$ -shell-container (cf. (i)). These  $\bullet\vdash$ -log-shells and log-volumes depend only on the mono-analyticized data (i.e., roughly speaking, the data contained in  $\mathcal{D}^{\vdash}$ ), in the following sense (cf., especially, (d)):

- (a) (Mono-analytic Cores) For  $n = 5, 6, 7$ ,  $\mathcal{D}_{\leq n}^{\bullet\vdash}$  admits a natural structure of core on the subdiagram of categories of  $\mathcal{D}^{\bullet\vdash}$  determined by the union  $\mathcal{D}_{\leq n-1}^{\bullet\vdash} \cup \mathcal{D}_{\leq n}^{\bullet\vdash}$  — i.e., loosely speaking,  $\mathcal{E}^{\vdash}$ ,

$\mathfrak{An}^+[\mathcal{N}^{\dagger\boxplus}]$  “form cores” of the functors in  $\mathcal{D}^{\bullet\dagger}$ .

- (b) (Mono-analytic Telecores) As  $v$  ranges over the elements of  $\mathbb{V}(F^{\text{mod}})$  and  $\nu$  over the elements of  $\vec{\Gamma}_v^\times$ , the restrictions

$$\phi_{v,\nu}^{\mathfrak{An}^{\dagger\boxplus}} : \mathfrak{An}^+[\mathcal{N}^{\dagger\boxplus}] \rightarrow \mathcal{N}_v^{\dagger\boxplus}$$

to  $\mathfrak{An}^+[\mathcal{N}^{\dagger\boxplus}]$  of the “forgetful functors”  $\psi_{v,\nu}^{\mathfrak{An}^{\dagger\boxplus}}$  of Proposition 5.8, (vii), give rise to a telecore structure  $\mathfrak{T}_{\mathfrak{An}^+}$  on  $\mathcal{D}_{\leq 5}^{\bullet\dagger} \cup \mathcal{D}_{\leq 6}^{\bullet\dagger}$ , whose underlying diagram of categories we denote by  $\vec{\mathcal{D}}_{\mathfrak{An}^+}$ , by appending to  $\mathcal{D}_{\leq 6}^{\bullet\dagger}$  telecore edges corresponding to the arrows  $\phi_{v,\nu}^{\mathfrak{An}^{\dagger\boxplus}}$  from the core  $\mathfrak{An}^+[\mathcal{N}^{\dagger\boxplus}]$  to the vertices of the row of  $\mathcal{D}^{\dagger}$  indexed by the integer 3. Moreover, the respective family of homotopies of  $\mathfrak{T}_{\mathfrak{An}^+}$  and the observables  $\mathfrak{S}_{\text{log}}$ ,  $\mathfrak{S}_{\text{log}\boxplus}$  of Corollary 5.5, (iii), are compatible.

- (c) (Mono-analytic Contact Structures) For  $v \in \mathbb{V}(F^{\text{mod}})$ ,  $\nu \in \vec{\Gamma}_v^\times$ , there is a natural isomorphism  $\eta_{v,\nu}^{\dagger}$  from the composite functor determined by the path  $\gamma_{v,\nu}^1$  (of length 6)

$$\begin{array}{ccccccc} \mathcal{X} & \xrightarrow{\lambda_{v,\nu}^{\boxplus}} & \mathcal{N}_v^{\boxplus} & \longrightarrow & \mathcal{N}_v & \longrightarrow & \mathcal{E}^\bullet \\ & & & & \downarrow & & \\ & & & & \mathcal{E}^{\dagger} & \longrightarrow & \mathfrak{An}^+[\mathcal{N}^{\dagger\boxplus}] \xrightarrow{\phi_{v,\nu}^{\mathfrak{An}^{\dagger\boxplus}}} \mathcal{N}_v^{\dagger\boxplus} \end{array}$$

on  $\vec{\Gamma}_{\mathcal{D}_{\mathfrak{An}^+}}$  — where the first three arrows lie in  $\mathcal{D}_{\leq 5}^{\bullet\dagger}$ , the fourth arrow arises from the mono-analyticization morphism  $\mathcal{D}_{\geq 3}^{\bullet\dagger} \rightarrow \mathcal{D}^{\dagger}$ , and the fifth arrow lies in  $\mathcal{D}^{\dagger}$  — to the composite functor determined by the path  $\gamma_{v,\nu}^0$  (of length 2)

$$\mathcal{X} \xrightarrow{\lambda_{v,\nu}^{\boxplus}} \mathcal{N}_v^{\boxplus} \longrightarrow \mathcal{N}_v^{\dagger\boxplus}$$

on  $\vec{\Gamma}_{\mathcal{D}_{\mathfrak{An}^+}}$ . Moreover, the resulting homotopies  $\eta_{v,\nu}^{\dagger}$ ,  $(\eta_{v,\nu}^{\dagger})^{-1}$ , together with the mono-analyticization homotopies and the homotopies on  $\mathcal{D}_{\mathfrak{An}^+}$  arising from the “ $\iota_{v,\epsilon}^{\mathfrak{An}^{\dagger\boxplus}}$ ” (cf. Proposition 5.8, (vii)), generate a contact structure  $\mathcal{H}_{\mathfrak{An}^+}$  on  $\mathfrak{T}_{\mathfrak{An}^+}$  that is compatible with the telecore and contact structures  $\mathfrak{T}_{\mathfrak{An}^\bullet}$ ,  $\mathcal{H}_{\mathfrak{An}^\bullet}$  of Corollary 5.5, (ii), as well as with the homotopies of the observables  $\mathfrak{S}_{\text{log}}$ ,  $\mathfrak{S}_{\text{log}\boxplus}$  of Corollary 5.5, (iii), that arise from the “ $\iota_{v,\epsilon}^{\boxplus}$ ”, “ $\iota_{v,\epsilon}$ ” indexed by  $\epsilon \in \vec{\Gamma}_v^\times$  (not  $\vec{\Gamma}_v^{\text{log}!}$ ).

(d) (Mono-analytic Log-shells) *If  $v \in \mathbb{V}(F^{\text{mod}})^{\text{non}}$  (respectively,  $v \in \mathbb{V}(F^{\text{mod}})^{\text{arc}}$ ), then we shall refer to as a  $\vdash$ -shell-container structure on an object  $S \in \text{Ob}(\mathcal{N}_v^{\dagger\boxplus})$  the datum of an object  $S' \in \text{Ob}(\mathfrak{An}^{\dagger}[\mathcal{N}_v^{\dagger\boxplus}])$ , together with an isomorphism from  $S \xrightarrow{\sim} \phi_{v,\nu}^{\mathfrak{An}^{\dagger\boxplus}}(S')$ , where  $\nu$  is the terminal (respectively, initial) vertex of the shell-arrow of  $\vec{\Gamma}_v^{\times}$ ; an object of  $\mathcal{N}_v^{\dagger\boxplus}$  equipped with a  $\vdash$ -shell-container structure will be referred to as a  $\vdash$ -shell-container. Note that the portion of the data that constitutes an object of  $\mathfrak{An}^{\dagger}[\mathcal{N}_v^{\dagger\boxplus}]$  determined by the shell-arrow gives rise to a  $\vdash$ -log-shell “ $\mathcal{I}$ ” inside each  $\vdash$ -shell-container, as well as to a log-volume on the Gal-superscripted module associated to a  $\vdash$ -shell-container (cf. Proposition 5.8, (ii), (iii), (v), (vi)). Finally, every  $\bullet\vdash$ -shell-container structure on an object of  $\mathcal{N}_v^{\dagger\boxplus}$  determines, by applying the isomorphism  $\eta_{v,\nu}^{\dagger}$  of (c), a corresponding  $\vdash$ -shell-container structure on the object; this correspondence between  $\bullet\vdash$ -,  $\vdash$ -shell-container structures is compatible with the  $\bullet\vdash$ -,  $\vdash$ -log-shells, as well as with the various log-volumes, determined, respectively, by these  $\bullet\vdash$ -,  $\vdash$ -shell-container structures.*

PROOF. The various assertions of Corollary 5.10 are immediate from the definitions, together with the references quoted in the statement of Corollary 5.10. Here, we note that in the *nonarchimedean* portion of part (c) of assertion (iv), in order to construct the isomorphisms  $\eta_{v,\nu}^{\dagger}$ , it is necessary to relate the construction of the base field as a subset of *abelianizations* of various open subgroups of the Galois group (cf. Proposition 5.8, (i)) to the *Kummer-theoretic* construction of the base field as performed in Theorem 1.9, (e). This may be achieved by applying the *group-theoretic construction algorithms* of Corollary 1.10 — i.e., more precisely, by combining the “*fundamental class*” *natural isomorphism* of Corollary 1.10, (a) (cf. also the first isomorphism of the display of Corollary 1.10, (b)), with the *cyclotomic natural isomorphism* of Corollary 1.10, (c) (cf. also Remark 1.10.3, (ii)). Put another way, this series of algorithms may be summarized as a “group-theoretic algorithm for constructing the *reciprocity map of local class field theory*”.  $\square$

REMARK 5.10.1.

(i) Note that, in the notation of Corollary 5.10, (iv), (c), by pre-composing  $\eta_{v,\nu}^\Gamma$  with the *telecore* arrow  $\phi_\square : \mathfrak{An}^\bullet[\mathcal{X}] \rightarrow \mathcal{X}$  of Corollary 5.5, (ii), and applying the *coricity* of Corollary 5.5, (i), together with an appropriate *mono-analyticization homotopy*, we obtain that one may think of  $\eta_{v,\nu}^\Gamma$  as yielding a homotopy from the path

$$\mathfrak{An}^\bullet[\mathcal{X}] \longrightarrow \mathfrak{An}^\Gamma[\mathcal{N}^{\Gamma\boxplus}] \xrightarrow{\phi_{v,\nu}^{\mathfrak{An}^\Gamma\boxplus}} \mathcal{N}_v^{\Gamma\boxplus}$$

— which is somewhat *simpler* (hence perhaps easier to grasp intuitively) than the domain path of the original homotopy  $\eta_{v,\nu}^\Gamma$  — to the path

$$\mathfrak{An}^\bullet[\mathcal{X}] \xrightarrow{\phi_\square} \mathcal{X} \xrightarrow{\lambda_{v,\nu}^{\boxplus}} \mathcal{N}_v^{\boxplus} \longrightarrow \mathcal{N}_v^{\Gamma\boxplus}$$

(i.e., obtained by simply pre-composing  $\gamma_{v,\nu}^0$  with  $\phi_\square$ ).

(ii) Note that the isomorphism of (i) between the two composites of functors  $\mathfrak{An}^\bullet[\mathcal{X}] \rightarrow \mathcal{N}_v^{\Gamma\boxplus}$  depends only on “*Galois-theoretic/Aut-holomorphic data*”. In particular, one may construct — in the style of Remarks 5.3.1, 5.9.1 — a category “ $\mathfrak{An}^\bullet[\mathcal{X}, \eta^\Gamma]$ ” whose *objects* consist of the data of objects of  $\mathfrak{An}^\bullet[\mathcal{X}]$ , together with the algorithms used to construct the various homotopies of (i) arising from  $\eta_{v,\nu}^\Gamma$  (i.e., associated to the various  $v \in \mathbb{V}(F^{\text{mod}})$ ,  $\nu \in \vec{\Gamma}_v^\times$ ), and whose *morphisms* are the morphisms induced by morphisms of  $\mathfrak{An}^\bullet[\mathcal{X}]$ . That is to say, objects of  $\mathfrak{An}^\bullet[\mathcal{X}, \eta^\Gamma]$  consist of objects of  $\mathfrak{An}^\bullet[\mathcal{X}]$ , together with “*group-theoretic algorithms encoding the reciprocity law of local class field theory at the nonarchimedean primes and the archimedean analogue of these algorithms at the archimedean primes*”. Moreover, the “forgetful functor”

$$\mathfrak{An}^\bullet[\mathcal{X}, \eta^\Gamma] \xrightarrow{\sim} \mathfrak{An}^\bullet[\mathcal{X}]$$

determines a *natural equivalence of categories*. Finally, one verifies immediately that one may replace “ $\mathfrak{An}^\bullet[\mathcal{X}]$ ” by “ $\mathfrak{An}^\bullet[\mathcal{X}, \eta^\Gamma]$ ” in Corollaries 5.5 and 5.10 without affecting the validity of their content — e.g., without affecting the *coricity* of Corollary 5.5, (i). We leave the routine details to the interested reader.

REMARK 5.10.2. The significance of the theory of *log-shells* as summarized in Corollary 5.10 — and, more generally, of the entire theory of the present paper — may be understood in more intuitive terms as follows.

(i) One important aspect of the classical theory of *line bundles on a proper curve* (over a field) is that although such line bundles exhibit a certain *rigidity arising from the properness* of the curve, this rigidity is obliterated by *Zariski localization* on the curve. Put another way, to work with line bundles up to isomorphism amounts to allowing oneself to “multiply the line bundle by a rational function”, i.e., to work up to *rational equivalence*. Although rational equivalence does not obliterate the *global degree* of a line bundle over the entire proper curve, if one thinks of a line bundle as a collection of *integral structures* at the various primes of the curve, then rational equivalence has the effect of “rearranging these integral structures” at the various primes.

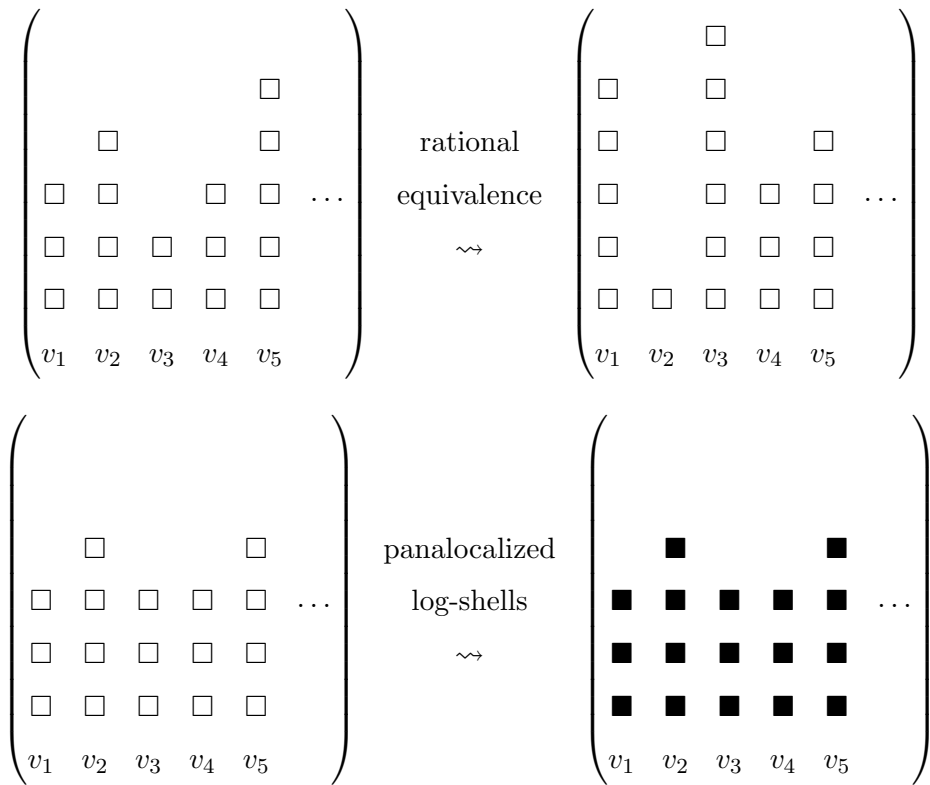

If one restricts oneself to working globally on the proper curve, then such “rearrangements” are coordinated with one another in such a way as to preserve, for instance, the global degree; on the other hand, if one further imposes the condition of compatibility with *Zariski localization*, then such



“coordination of integral structure” mechanisms are obliterated. By contrast, the “ $\mathcal{MF}^\nabla$ -objects” of [Falt] satisfy a certain “*extraordinary rigidity*” with respect to Zariski localization that reflects the fact that they form a category that is equivalent to a certain category of Galois representations. From the point of view of thinking of line bundles as collections of integral structures at the various primes, the rigidity of  $\mathcal{MF}^\nabla$ -objects may be thought of as a sort of “*freezing of the integral structures*” at the various primes in a fashion that is immune to the gluing indeterminacies that occur for line bundles upon execution of Zariski localization operations. Put another way, this rigidity may be thought of as a sort of “*immunity to social isolation*” from other primes. In the context of Corollary 5.10, this property corresponds to the *panalocalizability* (i.e., Corollary 5.10, (iii)) of (the integral structures constituted by) log-shells.

(ii) At this point, it is useful to observe that, at least from an *a priori* point of view, there exist other ways in which one might attempt to “freeze the local integral structures”. For instance, instead of working strictly with line bundles, one could consider the *ring structure* of the global ring of integers of a number field (which gives rise to the *trivial line bundle* — cf. Definition 5.3, (ii)); that is to say, by considering ring structures, one obtains a “rigid integral structure” that is compatible with Zariski localization — i.e., by considering the *ring structure* “ $\mathcal{O}$ ” of the local rings of integers (cf. Remark 5.4.3). Indeed, *log-shells* may be thought of — and, moreover, were originally intended by the author — as a sort of *approximation* of these local integral structures “ $\mathcal{O}$ ” (cf. Remark 5.4.2). On the other hand, this sort of rigidification of local integral structures that makes essential use of the ring structure is no longer compatible with the operation of *mono-analyticization* (cf. Remark 5.6.1), i.e., of forgetting one of the two combinatorial dimensions “ $\boxplus$ ”, “ $\boxtimes$ ” that constitute the ring structure. Thus, another crucial property of log-shells is their *compatibility with mono-analyticization*, as documented in Corollary 5.10, (iv) (cf. also Remarks 5.8.1, 5.9.2; Definition 5.9, (iii)), i.e., their “*immunity to social isolation*” from the given ring structures. From the point of view of the theory of §1, §2, §3, §4, such ring structures may be thought of as “*arithmetic holomorphic structures*” (i.e., outer Galois actions at nonarchimedean primes and Aut-holomorphic structures at archimedean primes) — cf. Remark 5.6.1. Thus, if one thinks of the result of *forgetting* such “arithmetic holomorphic structures” as be-

ing like a sort of “*arithmetic real analytic core*” on which *various “arithmetic holomorphic structures”* may be imposed — i.e., a sort of arithmetic analogue of the underlying real analytic surface of a Riemann surface, on which various holomorphic structures may be imposed (cf. Remark 5.10.3 below) — then the theory of mono-analyticization of log-shells guarantees that log-shells remain meaningful even as one *travels back and forth* between various “*zones of arithmetic holomorphy*” joined — in a fashion reminiscent of *spokes emanating from a core* — by a single “*mono-analytic core*”.

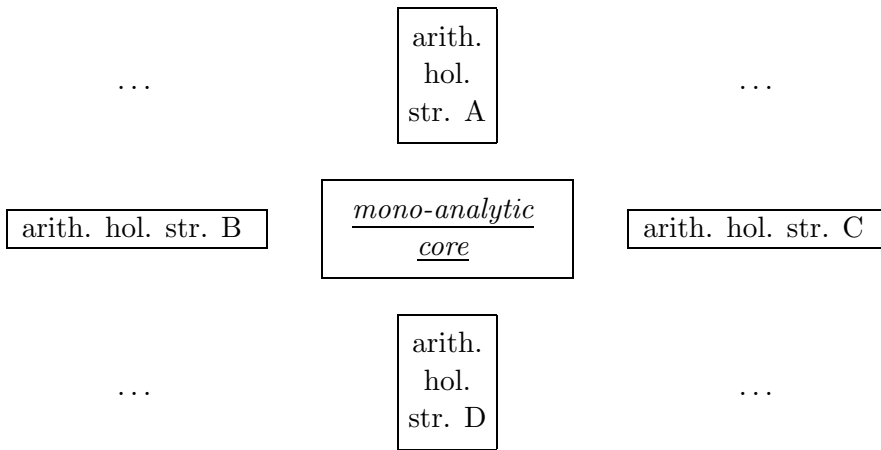

(iii) Another approach to constructing “mono-analytic rigid local integral structures” is to work with the local monoids “ $\mathcal{O}^{\triangleright}$ ” (i.e., as opposed to “ $\log(\mathcal{O}^{\times})$ ”, as was done in the case of log-shells). Here, “ $\mathcal{O}^{\triangleright}$ ” may be thought of as a (possibly twisted) product of “ $\mathcal{O}^{\times}$ ” with some “*valuation monoid*” that consists of a submonoid of  $\mathbb{R}_{\geq 0}$ . For instance, in the (complex) archimedean case,  $\mathcal{O}_{\mathbb{C}}^{\triangleright} \cong \mathcal{O}_{\mathbb{C}}^{\times} \times \mathbb{R}_{>0}$ . On the other hand (cf. Remark 5.6.1), the dimension constituted by the “valuation monoid”  $\mathbb{R}_{>0}$  *fails to retain its rigidity* when subjected to the operation of mono-analyticization. The resulting “*dilations*” of  $\mathbb{R}_{>0}$  (i.e., by raising to the  $\lambda$ -th power, for  $\lambda \in \mathbb{R}_{>0}$ ) may be thought of as being like *Teichmüller dilations* of the *mono-analytic core* discussed in (ii) above (cf. also the discussion of Remark 5.10.3 below). If, moreover, one is to retain a *coherent theory of global degrees* of arithmetic line bundles in the presence of such “arithmetic Teichmüller dilations”, then (in order to preserve the “*product formula*” of elementary number theory) it is necessary to subject the valuation monoids at *nonarchimedean primes*

to “arithmetic Teichmüller dilations” which are “*synchronized*” with the dilations that occur at the archimedean primes. From the point of the theory of *Frobenioids* of [Mzk16], [Mzk17], such “arithmetic Teichmüller dilations” at nonarchimedean primes are given by the *unit-linear Frobenius functor* studied in [Mzk16], Proposition 2.5. Thus, in summary:

In order to guarantee the *rigidity* of the local integral structures under consideration when subject to *mono-analyticization*, one must abandon the “valuation monoid” portion of “ $\mathcal{O}^\triangleright$ ”, i.e., one is obliged to restrict one’s attention to the “ $\mathcal{O}^\times$ ” portion of “ $\mathcal{O}^\triangleright$ ”.

On the other hand, within each *zone of arithmetic holomorphy* (cf. (ii)), one wishes to consider *various diverse modifications of integral structure* on the “rigid standard integral structures” that one constructs. Since this is not possible if one restricts oneself to “ $\mathcal{O}^\times$ ” *regarded multiplicatively*, one is thus led to working with “ $\log(\mathcal{O}^\times)$ ” — i.e., in effect with the *log-shells* discussed in Corollary 5.10. Thus, *within* each zone of arithmetic holomorphy, one wishes to convert the “ $\boxtimes$ ” operation of “ $\mathcal{O}^\times$ ” into a “ $\boxplus$ ” operation, i.e., by applying the *logarithm*. On the other hand, when one *leaves* that zone of arithmetic holomorphy, one wishes to *return* again to working with “ $\mathcal{O}^\times$ ” *multiplicatively*, so as to achieve compatibility with the operation of *mono-analyticization*. Here, we note that  $\boxtimes$ -line bundles — i.e., in other words, line bundles regarded from an *idèlic* point of view — have the virtue of being defined using only the *multiplicative* structure of the rings involved (cf. the theory of *Frobenioids* of [Mzk16], [Mzk17]), hence of being compatible with *mono-analyticization*. (We remark here that the detailed specification of precisely *which monoids* we wish to use when we apply the theory of *Frobenioids* is beyond the scope of the present paper.) By contrast, although  $\boxplus$ -line bundles — i.e., line bundles regarded as *modules* of a certain type — are not compatible with *mono-analyticization*, they have the virtue of allowing us to *relate*, *within* each zone of arithmetic holomorphy, the additive module “ $\log(\mathcal{O}^\times)$ ” to the theory of  $\boxtimes$ -line bundles (which is compatible with *mono-analyticization*). Thus, in summary:

This state of affairs obliges one to work in a “*framework*” in which one *may pass freely*, within each zone of arithmetic holomorphy, back and forth between “ $\boxplus$ ” and “ $\boxtimes$ ” via application of

the *logarithm* at the various nonarchimedean and archimedean primes.

On the other hand, since the logarithm is *not a ring homomorphism*, it is not at all clear, *a priori*, how to establish a framework in which one may apply the logarithm at will (within each zone of arithmetic holomorphy), without obliterating the *foundations* (e.g., scheme-theoretic!) underlying the mathematical objects that one works with, and, moreover, (a related issue — cf. Remark 5.4.1) without obliterating the *crucial global structure* of the number fields involved (which is necessary to make sense of global arithmetic line bundles!).

A *solution* to this problem of finding an appropriate “*framework*” as discussed above is precisely what is provided by “*Galois theory*” (cf. also the “*log-invariant log-volumes*” of Corollary 5.10, (i), (ii)) — which is both *global* and “*log-invariant*”; the *sufficiency* of this “framework” (from the point of view of carrying out various arithmetic operations involving line bundles, as discussed above) is precisely what is guaranteed by the *mono-anabelian* theory of Corollaries 3.6, 4.5, 5.5.

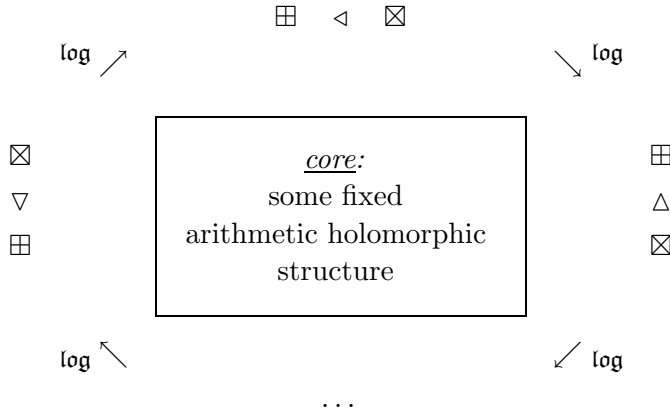

At a more philosophical level, the “*log-invariant core*” furnished by “Galois theory” (cf. the remarks concerning *telecores* following Corollaries 3.6, 3.7) and supported, in content, by “mono-anabelian geometry” may be thought of as a “*geometry over  $\mathbb{F}_1$* ” (i.e., over the fictitious field of absolute constants in  $\mathbb{Z}$ ) with respect to which the logarithm is “ *$\mathbb{F}_1$ -linear*”.

(iv) Note that in order to work with  $\boxplus$ -line bundles (cf. the discussion of (iii); Definition 5.3, (ii)), it is necessary (unlike the case with  $\boxtimes$ -line bundles) to work with *all the primes of a number field*. Indeed, to work with “line bundles” in a fashion that allows one to ignore some nonempty set of primes of the number field amounts to working with a notion of *rational equivalence* that involves some *proper subgroup* of the multiplicative group  $F^\times$  associated to the number field  $F$ . On the other, the only subgroups of  $F^\times$  that (if one considers the union of  $F^\times$  with  $\{0\}$ ) are *closed under addition* are the subgroups of  $F^\times$  that arise from *subfields* of  $F$ , i.e., which correspond, in effect, to  $\boxplus$ -line bundles as in Definition 5.3, (ii).

(v) The importance of the process of *mono-analyticization* in the discussion of (ii), (iii) is reminiscent of the discussion in [Mzk18], Remark 1.10.4, concerning the topic of “restricting oneself to working *only with multiplicative structures*” in the context of the theory of the *étale theta function*.

(vi) Finally, we recall that from the point of view of the discussion of *telecores* in the remarks following Corollaries 3.6, 3.7, the various “*forgetful functors*” of assertion (ii) of Corollaries 3.6, 4.5, 5.5 may be thought of as being analogous to passing to the “*underlying vector bundle plus Hodge filtration*” of an  $\mathcal{MF}^\nabla$ -object (cf. Remark 3.7.2). From this point of view:

*Log-shells* may be thought of, in the context of this analogy with  $\mathcal{MF}^\nabla$ -objects, as corresponding to the section of a (projective) nilpotent admissible indigenously bundle in positive characteristic determined by the *p-curvature* (i.e., in other words, the *Frobenius conjugate* of the Hodge filtration).

REMARK 5.10.3. From the point of view of the analogy of the theory of *mono-anabelian log-compatibility* (cf. §3, §4) with the theory of *uniformizing  $\mathcal{MF}^\nabla$ -objects* (cf. Remark 3.7.2), the *global/panalocal/mono-analytic theory of log-shells* presented in the present §5 may be understood as follows.

(i) The mathematical apparatus on a *number field* arising from the *global/pana-local mono-anabelian log-compatibility* of Corollary 5.5 may be thought of as being analogous to the (mod  $p$ )  $\mathcal{MF}^\nabla$ -object constituted by a *nilpotent indigenously bundle* on a hyperbolic curve in positive characteristic (cf. the theory of [Mzk1], [Mzk4]). Note that this mathematical apparatus

on a number field arises, essentially, from the *outer Galois representation* determined by a *once-punctured elliptic curve* over the number field. That is to say, roughly speaking, we have correspondences as follows:

$$\begin{array}{ll} \text{number field } F & \longleftrightarrow \text{hyperbolic curve } C \text{ in pos. char.} \\ \text{once-punctured ell. curve } X \text{ over } F & \longleftrightarrow \text{nilp. indig. bundle } P \text{ over } C. \end{array}$$

Here, we note that the correspondence between number fields and curves over finite fields is quite classical; the correspondence between families of elliptic curves and indigenous bundles is natural in the sense that the most fundamental example of an indigenous bundle is given by the projectivization of the first de Rham cohomology module of the tautological family of elliptic curves over the moduli stack of elliptic curves. Note, moreover, that:

Just as in the case of indigenous bundles, the fact that the *Kodaira-Spencer morphism* is an *isomorphism* may be interpreted as asserting that the *base curve* “entrusts its local moduli to the indigenous bundle”, in the mono-anabelian theory of the present paper, the *various localizations of a number field* “entrust their ring structures to the mono-anabelian data determined by the once-punctured elliptic curve” (cf. Remarks 1.9.4, 2.7.3, 5.6.1; Remark 5.10.2, (iii)).

Relative to this analogy, we observe that *panalocalizability* corresponds to the *local rigidity of  $\mathcal{MF}^\nabla$ -objects* (cf. Remark 5.10.2, (i)). Moreover, the operation of *mono-analyticization* — i.e., “forgetting the once-punctured elliptic curve” — corresponds to forgetting the indigenous bundle, hence to *relinquishing control of the local moduli* of the base curve  $C$ ; thus, just as this led to “*Teichmüller dilations*” in the discussion of Remark 5.10.2, (ii), (iii), in the theory of indigenous bundles, forgetting the indigenous bundle means, in particular, loss of control of the *deformation moduli* of the base curve  $C$ . Another noteworthy aspect of this analogy may be seen in the fact that:

Just as the *log-Frobenius* operation *only exists for local fields* (cf. Remark 5.4.1), in the theory of indigenous bundles, *Frobenius liftings only exist Zariski locally on the base curve  $C$* .

On the other hand, unlike the “*linear algebra-theoretic*” nature of the theory of indigenous bundles (which may be thought of as  $sl_2$ -bundles), the outer

Galois representations that appear in the theory of the present paper are *fundamentally “anabelian”* in nature — i.e., their “non-abelian nature” is not limited to a relatively weak “linear algebra-theoretic” departure from abelianity, but rather on a par with that of (profinite) *free groups*. In particular, unlike the linear algebra-theoretic (i.e., “ $sl_2$ -theoretic”) nature of the *intertwining of the two dimensions* of an indigenous vector bundle, the two combinatorial dimensions involved (cf. Remark 5.6.1) are *intertwined in an essentially anabelian fashion* (i.e., constitute a sort of “*noncommutative plane*”).

(ii) Once one has the “*rigid standard integral structures*” constituted by *log-shells* (cf. Remark 5.10.2, (iii)), it is natural to consider modifying these integral structures by means of the “*Gaussian zeroes*” (i.e., the inverse of the “*Gaussian poles*”) that appear in the *Hodge-Arakelov theory of elliptic curves* (cf., e.g., [Mzk6], §1.1). From the point of view of this theory, this amounts, in effect, to considering the “*crystalline theta object*” (cf. [Mzk7], §2). That is to say, the mathematical apparatus developed in the present §5 may be thought of as a sort of preparatory step, relative to the goal of constructing a “*global  $\mathcal{MF}^\nabla$ -object-type version of the crystalline theta object*”. This point of view is in line with the point of view of the Introduction to [Mzk18] (cf. also [Mzk18], Remark 5.10.2), together with the fact that the theory of the *étale theta function* given in [Mzk18], §1, involves, in an essential way, the theory of *elliptic cuspidalizations* (cf. Remark 2.7.2). Moreover, this point of view is reminiscent of the discussion in [Mzk7], §2, of the relation of crystalline theta objects to  $\mathcal{MF}^\nabla$ -objects — that is to say, the crystalline theta object has many properties that are similar to those of an  $\mathcal{MF}^\nabla$ -object, with the notable exception constituted by the *vanishing of the higher  $p$ -curvatures despite the fact that the Kodaira-Spencer morphism is an isomorphism* (cf. [Mzk7], Remark 2.11). This vanishing of higher  $p$ -curvatures, when viewed from the point of view of the theory of “*VF-patterns*” of indigenous bundles in [Mzk4], seems to suggest that, whereas the indigenous bundles considered in the  $p$ -adic uniformization theory of [Mzk4] are of “*finite Frobenius period*” (in the sense that they are fixed, up to isomorphism, by some *finite* number of applications of *Frobenius*), the crystalline theta object may only be equipped with an “ $\mathcal{MF}^\nabla$ -object structure” if one allows for *infinite Frobenius periods*. On the other hand, by comparison to the Frobenius morphisms that appear in the theory of

[Mzk4], the *log-Frobenius operation*  $\log$  certainly has the feel of an operation of “infinite order”. Moreover, as discussed in Remark 3.6.5, the *telecoricity* of the mathematical apparatus of Corollary 5.5 may be regarded as being analogous to *nilpotent, but non-vanishing  $p$ -curvature*. That is to say:

By considering the crystalline theta object not in the scheme-theoretic framework of (scheme-theoretic!) Hodge-Arakelov theory, but rather in the *mono-anabelian* framework of the present paper, one obtains a theory in which the “*contradiction*” (from the point of view of the classical theory of  $\mathcal{MF}^\nabla$ -objects) of “vanishing higher  $p$ -curvatures in the presence of a Kodaira-Spencer isomorphism” is *naturally resolved*.

The above discussion suggests that one may *refine* the correspondence between “once-punctured elliptic curves” and “indigenous bundles” discussed in (i) as follows:

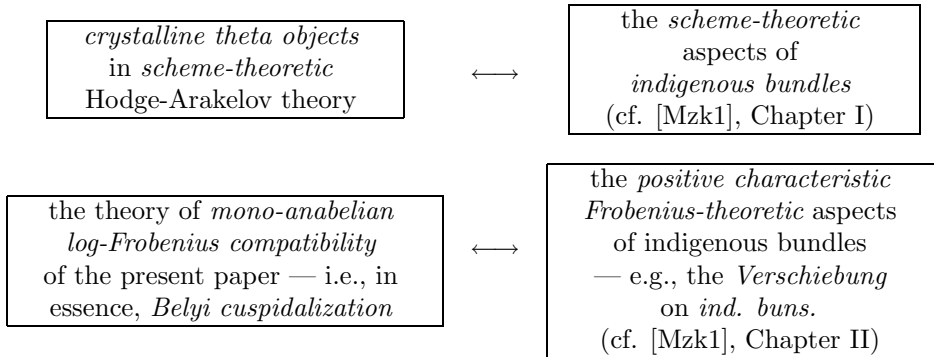

Note that the mono-anabelian theory of the present paper depends, in an essential way, on the technique of *Belyi cuspidalization* (cf. §1). Since the technique of *elliptic cuspidalization* (cf., e.g., the theory of [Mzk18], §1!) may be thought of as a sort of *simplified, linearized* (cf. (v) below) *version* of the technique of Belyi cuspidalization, and the *Frobenius action on square differentials* in the theory of [Mzk1], Chapter II, may be identified with the *derivative* (i.e., a sort of “simplified, linearized version”) of the *Verschiebung on indigenous bundles*, it is natural to supplement the correspondences given



above with the following further correspondence:

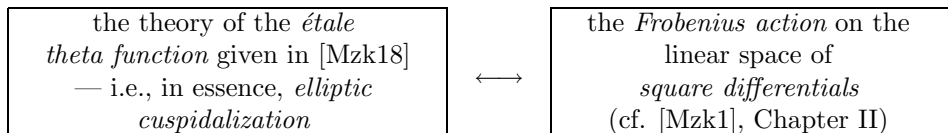

These analogies with the theory of [Mzk1], Chapter II, suggest the following further possible correspondences:

$$\begin{array}{l}
 \text{hyp. orbicurves of strictly Belyi type} \quad \overset{?}{\longleftrightarrow} \quad \text{nilp. admissible ind. buns.} \\
 \text{elliptically admissible hyp. orbicurves} \quad \overset{?}{\longleftrightarrow} \quad \text{nilp. ordinary ind. buns.}
 \end{array}$$

(i.e., where all of the hyperbolic orbicurves involved are defined over *number fields* — cf. Remark 2.8.3). At any rate, the correspondence with the theory of Chapters I, II of [Mzk1] suggests strongly the existence of a *theory of canonical liftings for number fields equipped with a once-punctured elliptic curve* that is analogous to the theory of Chapter III of [Mzk1]. The author hopes to develop such a theory in a future paper.

(iii) Relative to the discussion of “*units*” versus “*valuation monoids*” in Remark 5.10.2, (iii), the fact that the logarithm (i.e., log-Frobenius) has the effect of *converting* (a certain portion of) the “*units*” into a “*new log-generation valuation monoid*” is very much in line with the “*positive slope*” — i.e., “*telecore-theoretic*” — nature of a uniformizing  $\mathcal{MF}^\nabla$ -object (cf. the discussion of (i), (ii)). Indeed, from the point of view of uniformizations of a *Tate curve* (cf. the discussion of Remark 2.7.2; the discussion of the Introduction of [Mzk18]) the valuation monoid portion of an MLF corresponds precisely to “*slope zero*”, whereas the units of an MLF correspond to “*positive slope*”; a similar such correspondence also appears in classical formulations of *local class field theory*.

(iv) One important aspect of the theory of the present paper is that it is only applicable to *elliptically admissible* hyperbolic orbicurves, i.e., hyperbolic orbicurves that are closely related to a *once-punctured elliptic curve*. In light of the “*entrusting of local moduli/ring structure*” aspect of the theory of the present paper discussed in (i) above, it seems reasonable to suspect that this *special nature of once-punctured elliptic curves* (i.e., relative to the theory of the present paper) may be closely related to the fact that, unlike arbitrary hyperbolic orbicurves, the moduli stack of once-punctured elliptic

curves has *precisely one (holomorphic) dimension* (i.e., corresponding to the “one holomorphic dimension” of a number field). This “special nature of once-punctured elliptic curves” is also reminiscent of the observation made in [Mzk6], §1.5.2, to the effect that it does not appear possible (at least in any immediate way) to generalize the scheme-theoretic Hodge-Arakelov theory of elliptic curves either to higher-dimensional abelian varieties or to higher genus curves. Moreover, it is reminiscent of the *parallelogram-theoretic reconstruction algorithms* of Corollary 2.7, which, from the point of view of the theory of [Mzk14], §2, may only be performed canonically *once one chooses some fixed “one-dimensional space of square differentials”* — a choice which is not necessary in the elliptically admissible case, precisely because of the one-dimensionality of the moduli of once-punctured elliptic curves.

(v) Observe that the “*arithmetic Teichmüller dilations*” discussed in Remark 5.10.2, (iii) — which deform the “*arithmetic holomorphic structure*” — are *linear* in nature (cf., e.g., the “unit-linear Frobenius functor”). On the other hand, the *log-Frobenius operation* within each “*zone of arithmetic holomorphy*” is “*non-linear*”, with respect to both the additive and multiplicative structures of the rings involved. Indeed, as discussed extensively in the remarks following Corollaries 3.6, 3.7 (cf. also the discussion in the latter half of Remark 5.10.2, (iii)), the essential reason for the introduction of *mono-anabelian geometry* in the present paper is precisely the need to deal with this non-linearity. In the classical theory of Teichmüller deformations of Riemann surfaces, the deformations of holomorphic structure are *linear* (cf. the approach to this theory given in [Mzk14], §2). On the other hand, *non-linearity* may be witnessed in classical Teichmüller theory in the *quadratic* nature of the square differentials. Typically, non-linearity is related to some sort of “*bounded domain*”. In the complex theory, the *bounded nature* of the upper half-plane, as well as of Teichmüller space itself, constitute examples of this phenomenon — cf. the discussion of “Frobenius-invariant integral structures” in [Mzk4], Introduction, §0.4. In the case of elliptic curves, the quadratic nature of the square differentials corresponds precisely to the *quadratic nature of the exponent* that appears in the classical series representation of the *theta function*; moreover, this quadratic correspondence “ $\mathbb{Z} \ni n \mapsto n^2 \in \mathbb{Z}$ ” is (unlike the linear correspondence  $n \mapsto c \cdot n$ , for  $c \in \mathbb{Z}$ ) *bounded from below*. Returning to the theory of *log-shells*, let

us recall that the *non-linear* log-Frobenius operation is used precisely to achieve the *crucial boundedness* (i.e., “compactness”) property of log-shells (cf. the discussion of Remark 5.10.2!). Also, relative to the discussion of (ii) above, let us recall that the goal of constructing a comparison isomorphism between *non-linear compact domains of function spaces* formed one of the key motivations for the development of the Hodge-Arakelov theory of elliptic curves (cf. [Mzk6], §1.3.2, §1.3.3).

(vi) Relative to the analogy between “once-punctured elliptic curves over number fields” and “nilpotent indigenous bundles” (cf. (i)), it is interesting to note that if one thinks of the number fields involved as “*log number fields*” — i.e., number fields equipped with a finite set of primes at which the elliptic curve is allowed to have bad (but multiplicative!) reduction — then *Siegel’s classical finiteness theorem* (which implies the finiteness of the set of isomorphism classes of elliptic curves over a given “log number field”) may be regarded as the analogue of the *finiteness of the Verschiebung on indigenous bundles* given in [Mzk1], Chapter II, Theorem 2.3 (which implies the finiteness of the set of isomorphism classes of nilpotent indigenous bundles over a given hyperbolic curve in positive characteristic).

REMARK 5.10.4. The analogy with *Frobenius liftings* that appears in the discussion of Remark 5.10.3 is interesting from the point of view of the theory of [Mzk21], §2 (cf., especially [Mzk21], Remark 2.9.1). Indeed, [Mzk21], §2, may be thought of as a theory concerning the issue of *passing from decomposition groups to ring (i.e., additive!) structures* in a  $p$ -adic setting (cf. [Mzk21], Corollary 2.9), hence may be thought of as a sort of  $p$ -adic analogue of the *lemma of Uchida* reviewed in Proposition 1.3.

## Appendix. Complements on Complex Multiplication

In the present Appendix, we expose the portion of the *well-known theory of abelian varieties with complex multiplication* (cf., e.g., [Lang-CM], [Milne-CM], for more details) that underlies the observation “ $(\ast^{\text{CM}})$ ” — i.e., roughly speaking, to the effect that, if  $p$  is a prime number, then

every *Lubin-Tate character* on an open subgroup of the inertia group of the absolute Galois group of a  $p$ -adic local field arises,

after possible restriction to an open subgroup, from a subquotient of the  $p$ -adic Tate module associated to an *abelian variety* with *complex multiplication*

— related to the author by *A. Tamagawa* (cf. [Mzk20], Remark 3.8.1). In particular, we *verify* that this observation ( $*^{\text{CM}}$ ) does indeed hold. (Here, we remark in passing that the proof of ( $*^{\text{CM}}$ ) given in the present Appendix is, according to Tamagawa, apparently somewhat different from the proof that he originally considered. Unfortunately, however, he was unable to recall the details of his original argument.) This implies that the observation “( $*^{\text{A-qLT}}$ )” discussed in [Mzk20], Remark 3.8.1, also holds, and hence, in particular, that the hypothesis of [Mzk20], Corollary 3.9, to the effect that “either ( $*^{\text{A-qLT}}$ ) or ( $*^{\text{CM}}$ ) holds” may be *eliminated* (i.e., that [Mzk20], Corollary 3.9, holds *unconditionally*). On the other hand, we conclude the present Appendix by observing that, in this context, there still remains an interesting *open problem* that could serve to stimulate further research.

In the following, we shall fix a *prime number*  $p$  and write  $\mathbb{Q}$  for the field of *rational numbers*,  $\mathbb{Z}_p$  for the topological ring of  *$p$ -adic integers*,  $\mathbb{Q}_p$  for the topological field of  *$p$ -adic numbers*,  $\mathbb{R}$  for the topological field of *real numbers*,  $\mathbb{C}$  for the topological field of *complex numbers*,  $\iota : \mathbb{C} \rightarrow \mathbb{C}$  for the automorphism of  $\mathbb{C}$  given by *complex conjugation*, and  $\mathbb{Q}^{\text{alg}} \subseteq \mathbb{C}$  for the subfield of *algebraic numbers*. Also, we shall use the notation “ $\mathcal{O}$ ” to denote the *ring of integers* associated to a finite extension of  $\mathbb{Q}$  or  $\mathbb{Q}_p$  and the notation “ $\text{tr}_{(-)}$ ” to denote the *trace map* associated to a finite field extension “ $(-)$ ”.

(CM1) Fix a finite extension  $L$  of degree  $d \geq 1$  of  $\mathbb{Q}_p$ . Thus,  $L = \mathbb{Q}_p(\alpha)$  for some  $\alpha \in L$ . Let  $f(x) \in \mathbb{Q}_p[x]$  be a monic irreducible polynomial such that  $f(\alpha) = 0$ . If  $d = 2$ , then set  $g(x) \stackrel{\text{def}}{=} x^2 + 1$ ; if  $d \neq 2$ , then set  $g(x) \stackrel{\text{def}}{=} (x-1)(x-2)\cdots(x-d)$ . Thus, both  $f(x) \in \mathbb{Q}_p[x]$  and  $g(x) \in \mathbb{Q}[x]$  are of degree  $d$ . Then by approximating the coefficients of  $f$  and  $g$  by elements of  $\mathbb{Q}$  at the  $p$ -adic and real places of  $\mathbb{Q}$ , we conclude that there exists a *monic polynomial*  $h(x) \in \mathbb{Q}[x]$  of degree  $d$  such that the following conditions hold:

- (a) there exists an element  $\beta \in L$  such that  $h(\beta) = 0$  and  $L = \mathbb{Q}_p(\beta)$ ;

- (b) if  $d = 2$ , then the complex roots of  $h(x)$  are *non-real* and *distinct*;
- (c) if  $d \neq 2$ , then the complex roots of  $h(x)$  are *real* and *distinct*.

Indeed, (a) follows by arguing as in [Kobl], pp. 69-70; (b) follows by considering the *sign* of the *discriminant* of  $h(x)$ ; (c) follows by considering the *signs of values* of  $g(x)$  as  $x$  varies over the real numbers in the various *intervals between roots* of  $g(x)$ . Note that it follows from (a) that the polynomial  $h(x) \in \mathbb{Q}[x]$  is *irreducible*. Thus, we obtain a *number field*

$$F \stackrel{\text{def}}{=} \mathbb{Q}[x]/(h(x))$$

such that  $[F : \mathbb{Q}] = d$ , and  $F \otimes_{\mathbb{Q}} \mathbb{Q}_p$  is isomorphic to  $L$ . If  $d = 2$ , then  $F$  is a *complex quadratic extension* of  $\mathbb{Q}$ , hence admits an element  $\gamma \in F \setminus \mathbb{Q}$  such that  $\gamma^2 \in \mathbb{Q}$  (which implies that  $\gamma^2 < 0$ ,  $F = \mathbb{Q}(\gamma)$ ). Next, let us observe (cf. [Kobl], p. 81) that  $1 - p^3$  admits a *square root* in  $\mathbb{Q}_p$ . Thus, if  $d \neq 2$ , then the number field  $F$  is *totally real* and hence *linearly disjoint* over  $\mathbb{Q}$  from the *complex quadratic extension*  $K_0 \stackrel{\text{def}}{=} \mathbb{Q}(\lambda_0)$ , where  $\lambda_0^2 = 1 - p^3$ . In particular, if  $d \neq 2$ , then the number field

$$K \stackrel{\text{def}}{=} F \cdot K_0$$

is a *CM field* (cf., e.g., [Lang-CM], Chapter 1, §2) of degree  $2d$  over  $\mathbb{Q}$ .

(CM2) Suppose that  $d = 2$ . Let  $\varphi_0 : F \hookrightarrow \mathbb{C}$  be an *embedding* such that the imaginary part of  $\varphi_0(\gamma)$  is *positive*. Write  $\iota_F \in \text{Gal}(F/\mathbb{Q})$  for the unique nontrivial element of  $\text{Gal}(F/\mathbb{Q})$  (so  $\varphi_0 \circ \iota_F = \iota \circ \varphi_0$ ). Then recall (cf., e.g., [Lang-CM], Chapter 1, §4) that the *complex torus*  $\mathbb{C}/\varphi_0(\mathcal{O}_F)$ , together with the *Riemann form* determined by the pairing  $(\xi, \eta) \mapsto \text{tr}_{F/\mathbb{Q}}(\xi \cdot \iota_F(\eta) \cdot \gamma) \in \mathbb{Q}$  (where  $\xi, \eta \in F$ ), determine an *elliptic curve*  $E$  with *complex multiplication* by  $\mathcal{O}_F$ , which is defined over some finite subextension  $M$  of  $\varphi_0(F)$  in  $\mathbb{C}$ . Now it is immediate from the *Main Theorem of Complex Multiplication* (i.e., *Shimura reciprocity* — cf., e.g., [Lang-CM], Chapter 4, Theorem 1.1; [Milne-CM], Theorem 10.1) that there exists an *open subgroup*  $H$  of the *inertia group*  $\subseteq G_M \stackrel{\text{def}}{=} \text{Gal}(\mathbb{Q}^{\text{alg}}/M)$  associated to some prime of  $\mathbb{Q}^{\text{alg}}$  that divides  $p$  such that  $H$  acts on the  $p$ -adic Tate module associated to  $E$  via the *Lubin-Tate character* associated to  $L$ . This completes the proof of  $(*)^{\text{CM}}$  in the case  $d = 2$ .

(CM3) Suppose that  $d \neq 2$ . Let  $\Phi_0$  be a collection of  $d$  embeddings  $K \hookrightarrow \mathbb{C}$  of  $K$  into the complex numbers such that every embedding  $F \hookrightarrow \mathbb{C}$  is obtained as the restriction of an element of  $\Phi_0$ , and, moreover, the embeddings of  $\Phi_0$  map  $\lambda_0$  to a complex number whose imaginary part is *positive*. (Thus, the embeddings of  $\Phi_0$  *coincide* on  $K_0$ .) Fix an element  $\varphi_0 \in \Phi_0$ . Thus, one verifies immediately that both  $\Phi_0$  and

$$\Phi \stackrel{\text{def}}{=} \{\varphi_0\} \cup \{\iota \circ \varphi \mid \varphi_0 \neq \varphi \in \Phi_0\}$$

form *CM types* of  $K$  (cf., e.g., [Lang-CM], Chapter 1, §2). Moreover, if we write  $\Phi'_0 \stackrel{\text{def}}{=} \{\iota \circ \varphi \mid \varphi \in \Phi_0\}$ , then one verifies immediately that the set of embeddings  $K \hookrightarrow \mathbb{C}$  (or, equivalently,  $K \hookrightarrow \mathbb{Q}^{\text{alg}}$ )

$$\Phi_0 \cup \Phi'_0 \xrightarrow{\sim} \Phi_0 \times \{\text{id}, \iota\}$$

(where  $\text{id}$  denotes the identity automorphism of  $\mathbb{C}$ ) admits a *natural action* by  $G_{\mathbb{Q}} \stackrel{\text{def}}{=} \text{Gal}(\mathbb{Q}^{\text{alg}}/\mathbb{Q})$  that *preserves* the *product decomposition* (induced by restricting the embeddings in question to  $F$  or  $K_0$ ) of the above display. Then one verifies immediately that the subgroup of  $G_{\mathbb{Q}}$  that *stabilizes*  $\Phi_0$  is equal to  $G_{K_0} \stackrel{\text{def}}{=} \text{Gal}(\mathbb{Q}^{\text{alg}}/K_0)$ , and hence that the *reflex field* (cf., e.g., [Lang-CM], Chapter 1, §5) associated to  $(K, \Phi_0)$  is equal to  $\varphi_0(K_0)$ . On the other hand, observe that our assumption that  $d \neq 2$  implies that the *cardinalities* (namely, 1 and  $d-1$ ) of the intersections  $\Phi \cap \Phi_0$  and  $\Phi \cap \Phi'_0$  are *distinct*. Thus, since the action of *any* element of  $G_{\mathbb{Q}}$  on  $\Phi_0 \cup \Phi'_0$  is *compatible* with the *projection* to the set  $\{\text{id}, \iota\}$ , one verifies immediately (by considering the *fibers*, i.e.,  $\Phi_0$  and  $\Phi'_0$ , of this projection) that our assumption that  $d \neq 2$  implies that an element of  $G_{\mathbb{Q}}$  *stabilizes*  $\Phi$  if and only if it *fixes*  $\varphi_0$ . In particular, we conclude that the *reflex field* (cf., e.g., [Lang-CM], Chapter 1, §5) associated to  $(K, \Phi)$  is equal to  $\varphi_0(K)$ .

(CM4) We continue our analysis of the situation discussed in (CM3). Write  $\iota_K \in \text{Gal}(K/F)$  for the unique nontrivial element of  $\text{Gal}(K/F)$  (so  $\varphi \circ \iota_K = \iota \circ \varphi$ , for all  $\varphi \in \Phi$ ). Observe that by approximating  $\lambda_0$  relative to  $\varphi_0$  and  $-\lambda_0$  relative to  $\varphi \in \Phi \setminus \{\varphi_0\}$ , one may construct an element  $\lambda \in K$  such that the imaginary part of  $\varphi(\lambda)$  is *positive* for all  $\varphi \in \Phi$ . Moreover, by replacing  $\lambda$  by  $\lambda - \iota_K(\lambda)$ , one may assume without loss of generality that  $\iota_K(\lambda) = -\lambda$ . Next, recall (cf., e.g., [Lang-CM], Chapter 1, §4) that the *CM type*  $(K, \Phi)$ , together with the *lattice*  $\mathcal{O}_K \subseteq K$  and the *Riemann form*

determined by the pairing  $(\xi, \eta) \mapsto \text{tr}_{K/\mathbb{Q}}(\xi \cdot \iota_K(\eta) \cdot \lambda) \in \mathbb{Q}$  (where  $\xi, \eta \in K$ ), determine a *polarized abelian variety*  $A$  with *complex multiplication* by  $\mathcal{O}_K$ , which is defined over some finite subextension  $M$  of  $\varphi_0(K)$  in  $\mathbb{C}$ . Next, write  $G_M \stackrel{\text{def}}{=} \text{Gal}(\mathbb{Q}^{\text{alg}}/M)$ ,  $T_p(A)$  for the *p-adic Tate module* associated to  $A$ . Thus,  $T_p(A)$  admits a natural structure of *rank one free  $\mathcal{O}_K \otimes \mathbb{Z}_p$ -module*, as well as a natural  $G_M$ -action. In particular, since  $\mathcal{O}_K \otimes \mathbb{Z}_p \cong \mathcal{O}_L \oplus \mathcal{O}_L$ , we thus conclude that  $T_p(A)$  admits a *direct sum decomposition*  $T_p(A) = T' \oplus T''$  as a direct sum of *rank one free  $\mathcal{O}_L$ -modules*  $T', T''$ . On the other hand, let us recall that the *Main Theorem of Complex Multiplication* (i.e., *Shimura reciprocity* — cf., e.g., [Lang-CM], Chapter 4, Theorem 1.1; [Milne-CM], Theorem 10.1) allows one to compute the Galois action of  $G_M$  on  $T_p(A)$  by means of the *reflex type norm* applied to an *idèle* of  $M$ . In particular, it follows immediately from our *construction of  $\Phi$  from  $\Phi_0$*  in (CM3), together with the resulting computation of the associated *reflex field*, that, after possibly interchanging  $T'$  and  $T''$ , there exists an *open subgroup*  $H$  of the *inertia group*  $\subseteq G_M$  associated to some prime of  $\mathbb{Q}^{\text{alg}}$  that divides  $p$  such that  $H$  acts on  $T_1$  via the *Lubin-Tate character*

$$\chi_{\text{LT}} : H \rightarrow \mathcal{O}_L^\times$$

associated to  $L$  (i.e., in essence, *via the embedding  $\varphi_0$* ) and on  $T_2$  via the *dual character*

$$\chi_{\text{LT}}^* : H \rightarrow \mathcal{O}_L^\times$$

(that is to say, the character determined by the relation  $\chi_{\text{LT}} \cdot \chi_{\text{LT}}^* = \chi_{\text{cycl}}$ , where  $\chi_{\text{cycl}} : H \rightarrow \mathbb{Z}_p^\times$  is the *cyclotomic character*, i.e., in essence, *via the product of the embeddings  $\in \Phi \setminus \{\varphi_0\}$* ). This completes the proof of the observation  $(*^{\text{CM}})$  (for arbitrary  $d$ ).

(CM5) The above argument completes the proof of the observation  $(*^{\text{CM}})$  and hence also of the observation  $(*^{\text{A-qLT}})$ , of [Mzk20], Remark 3.8.1. On the other hand, we conclude by observing that, in this context, the following *problem* remains *unresolved*:

Let  $X$  be a *hyperbolic curve* over a finite extension  $k$  of  $\mathbb{Q}_p$ . Then is it always the case that the étale fundamental group of  $X$  is of *A-qLT-type* (cf. [Mzk20], Definition 3.1, (v))?

Here, we recall that, roughly speaking, this condition of being “of A-qLT-type” may be described as the condition that every Lubin-Tate character on

the inertia subgroup of an open subgroup of the absolute Galois group of  $k$  arises, after possibly restricting to an open subgroup, from some subquotient of the  $p$ -adic Tate module of the Jacobian of a finite étale covering of  $X$  (cf. [Mzk20], Definition 3.1, (v), for more details). Thus,  $(*^{\text{A-qLT}})$  consists of the assertion that this problem admits an affirmative answer whenever  $X$  admits a finite étale covering that, in turn, admits a dominant map to a copy of the projective line minus three points over  $k$ . We recall from [Mzk20], Remark 3.8.1, that  $(*^{\text{A-qLT}})$  is derived from  $(*^{\text{CM}})$  by using *Belyi maps*. Thus, the above unresolved problem is particularly of interest in the case of various “classes” of  $X$  for which *techniques involving Belyi maps cannot be applied*, e.g., the case of *proper*  $X$ . Finally, we observe that

this problem may also be understood in the context of the general theme of *applications of Belyi maps*, i.e., in the style of *Belyi injectivity* or [André], Theorems 7.2.1, 7.2.3 (which may be thought of as a sort of  $p$ -adic version of Belyi injectivity).

In the case of Belyi injectivity or André’s results, a version for *arbitrary hyperbolic curves* was obtained, by applying techniques from *combinatorial anabelian geometry*, in [HM1], Theorem C (in the case of Belyi injectivity) and [HM2], Theorem B (in the case of André’s results). On the other hand, in the case of the unresolved problem discussed above, it is not clear to the author at the present time how to apply techniques from combinatorial anabelian geometry to resolve this problem.

### References

- [André] André, Y., On a Geometric Description of  $\text{Gal}(\overline{\mathbb{Q}}_p/\mathbb{Q}_p)$  and a  $p$ -adic Avatar of  $\widehat{GT}$ , *Duke Math. J.* **119** (2003), 1–39.
- [ArTt] Artin, E. and J. Tate, *Class Field Theory*, Addison-Wesley (1990).
- [Falt] Faltings, G., Crystalline Cohomology and  $p$ -adic Galois Representations, *JAMI Conference*, Johns Hopkins Univ. Press (1990), 25–79.
- [HM1] Hoshi, Y. and S. Mochizuki, On the Combinatorial Anabelian Geometry of Nodally Nondegenerate Outer Representations, *Hiroshima Math. J.* **41** (2011), 275–342.
- [HM2] Hoshi, Y. and S. Mochizuki, *Topics Surrounding the Combinatorial Anabelian Geometry of Hyperbolic Curves III: Tripods and Tempered Fundamental Groups*, RIMS Preprint **1763** (November 2012).



- [Ih] Ihara, Y., Lifting Curves over Finite Fields Together with the Characteristic Correspondence  $\Pi + \Pi'$ , *Jour. of Algebra* **75** (1982), 452–483.
- [Kobl] Koblitz, N., *p-adic Numbers, p-adic Analysis, and Zeta Functions*, Graduate Texts in Mathematics **58**, Springer-Verlag (1977).
- [Lang-CM] Lang, S., *Complex Multiplication*, Grundlehren der Mathematischen Wissenschaften **255**, Springer-Verlag (1983).
- [Milne-CM] Milne, J. S., *Complex Multiplication*, manuscript available at the following address: <http://www.jmilne.org/math/CourseNotes/cm.html>.
- [Mzk1] Mochizuki, S., A Theory of Ordinary  $p$ -adic Curves, *Publ. of RIMS* **32** (1996), 957–1151.
- [Mzk2] Mochizuki, S., A Version of the Grothendieck Conjecture for  $p$ -adic Local Fields, *The International Journal of Math.* **8** (1997), 499–506.
- [Mzk3] Mochizuki, S., Correspondences on Hyperbolic Curves, *Journ. Pure Appl. Algebra* **131** (1998), 227–244.
- [Mzk4] Mochizuki, S., *Foundations of p-adic Teichmüller Theory*, AMS/IP Studies in Advanced Mathematics **11**, American Mathematical Society/International Press (1999).
- [Mzk5] Mochizuki, S., The Local Pro- $p$  Anabelian Geometry of Curves, *Invent. Math.* **138** (1999), 319–423.
- [Mzk6] Mochizuki, S., A Survey of the Hodge-Arakelov Theory of Elliptic Curves I, *Arithmetic Fundamental Groups and Noncommutative Algebra*, Proceedings of Symposia in Pure Mathematics **70**, American Mathematical Society (2002), pp. 533–569.
- [Mzk7] Mochizuki, S., A Survey of the Hodge-Arakelov Theory of Elliptic Curves II, *Algebraic Geometry 2000, Azumino*, Adv. Stud. Pure Math. **36**, Math. Soc. Japan (2002), pp. 81–114.
- [Mzk8] Mochizuki, S., Topics Surrounding the Anabelian Geometry of Hyperbolic Curves, *Galois Groups and Fundamental Groups*, Mathematical Sciences Research Institute Publications **41**, Cambridge University Press (2003), pp. 119–165.
- [Mzk9] Mochizuki, S., The Absolute Anabelian Geometry of Hyperbolic Curves, *Galois Theory and Modular Forms*, Kluwer Academic Publishers (2004), pp. 77–122.
- [Mzk10] Mochizuki, S., The Absolute Anabelian Geometry of Canonical Curves, *Kazuya Kato's fiftieth birthday*, Doc. Math. 2003, Extra Vol., pp. 609–640.
- [Mzk11] Mochizuki, S., The Geometry of Anabelioids, *Publ. Res. Inst. Math. Sci.* **40** (2004), 819–881.
- [Mzk12] Mochizuki, S., Galois Sections in Absolute Anabelian Geometry, *Nagoya Math. J.* **179** (2005), 17–45.

- [Mzk13] Mochizuki, S., Semi-graphs of Anabelioids, *Publ. Res. Inst. Math. Sci.* **42** (2006), 221–322.
- [Mzk14] Mochizuki, S., Conformal and Quasiconformal Categorical Representation of Hyperbolic Riemann Surfaces, *Hiroshima Math. J.* **36** (2006), 405–441.
- [Mzk15] Mochizuki, S., Global Solvably Closed Anabelian Geometry, *Math. J. Okayama Univ.* **48** (2006), 57–71.
- [Mzk16] Mochizuki, S., The Geometry of Frobenioids I: The General Theory, *Kyushu J. Math.* **62** (2008), 293–400.
- [Mzk17] Mochizuki, S., The Geometry of Frobenioids II: Poly-Frobenioids, *Kyushu J. Math.* **62** (2008), 401–460.
- [Mzk18] Mochizuki, S., The Étale Theta Function and its Frobenioid-theoretic Manifestations, *Publ. Res. Inst. Math. Sci.* **45** (2009), 227–349.
- [Mzk19] Mochizuki, S., Absolute anabelian cuspidalizations of proper hyperbolic curves, *J. Math. Kyoto Univ.* **47** (2007), 451–539.
- [Mzk20] Mochizuki, S., Topics in Absolute Anabelian Geometry I: Generalities, *J. Math. Sci. Univ. Tokyo* **19** (2012), 139–242.
- [Mzk21] Mochizuki, S., Topics in Absolute Anabelian Geometry II: Decomposition Groups and Endomorphisms, *J. Math. Sci. Univ. Tokyo* **20** (2013), 171–269.
- [MT] Mochizuki, S. and A. Tamagawa, The algebraic and anabelian geometry of configuration spaces, *Hokkaido Math. J.* **37** (2008), 75–131.
- [NSW] Neukirch, J., Schmidt, A. and K. Wingberg, *Cohomology of number fields*, *Grundlehren der Mathematischen Wissenschaften* **323**, Springer-Verlag (2000).
- [Pop] Pop, F., On Grothendieck’s conjecture of anabelian birational geometry, *Ann. of Math.* **138** (1994), 147–185.
- [Serre] Serre, J.-P., *Lie Algebras and Lie Groups*, *Lecture Notes in Mathematics* **1500**, Springer Verlag (1992).
- [Stix] Stix, J., Affine anabelian curves in positive characteristic, *Compositio Math.* **134** (2002), 75–85.
- [Tama] Tamagawa, A., The Grothendieck Conjecture for Affine Curves, *Compositio Math.* **109** (1997), 135–194.
- [Uchi] Uchida, K., Isomorphisms of Galois groups of algebraic function fields, *Ann. of Math.* **106** (1977), 589–598.

(Received March 27, 2008)

(Revised August 10, 2015)

Research Institute for Mathematical Sciences  
Kyoto University  
Kyoto 606-8502, Japan  
E-mail: motizuki@kurims.kyoto-u.ac.jp